

TRAFFIC IMPACT STUDY

For

**Alexander Way Residential
Castle Rock, Colorado**

October 2022
Revised:
November 2022

Prepared for:

455 Alexander LLC
700 17th Street, Suite 200
Denver, Colorado 80231

Prepared by:



SM ROCHA, LLC
TRAFFIC AND TRANSPORTATION CONSULTANTS

8703 Yates Drive, Suite 210
Westminster, Colorado 80031
(303) 458-9798

6 South Tejon Street, Suite 515
Colorado Springs, Colorado 80903
(719) 203-6639

Project Engineer:
Brandon Wilson, EIT

Engineer in Responsible Charge:
Fred Lantz, PE



21-061456

Table of Contents	Page
I. Introduction	1
Project Overview.....	1
Study Area Boundaries	1
Site Description.....	1
Existing and Committed Surface Transportation Network.....	4
II. Existing Traffic Conditions	6
Existing Traffic Analysis Results	11
III. Future Traffic Conditions Without Proposed Development.....	12
Background Traffic Analysis Results – Year 2023	19
Background Traffic Analysis Results – Year 2041	21
IV. Proposed Project Traffic	22
Trip Generation.....	22
Adjustments to Trip Generation Rates	23
Trip Distribution.....	23
Trip Assignment.....	23
Development Impacts	23
V. Future Traffic Conditions With Proposed Developments	25
VI. Project Impacts	30
Peak Hour Intersection Levels of Service	30
Total Traffic Analysis Results Upon Development Build-Out	33
Queue Length Analysis – Founders Parkway & Allen Way.....	34
VII. Additional Analysis.....	35
Peak Hour Intersection Levels of Service	35
Total Traffic Analysis Results Upon Development Build-Out – Additional Analysis	35
VIII. Conclusion	37

List of Figures

Page

Figure 1 – Location.....2

Figure 2 – Site Plan.....3

Figure 3 – Existing Traffic Volumes.....7

Figure 4 – Existing Traffic Intersection Lane Geometry.....8

Figure 5 – Background Traffic Volumes – Year 2023.....13

Figure 6 – Background Traffic Intersection Lane Geometry – Year 2023.....14

Figure 7 – Background Traffic Volumes – Year 2041.....15

Figure 8 – Background Traffic Intersection Lane Geometry – Year 2041.....16

Figure 9 – Distribution and Site Generated Assignment.....24

Figure 10 – Total Traffic Volumes – Year 2023.....26

Figure 11 – Total Traffic Intersection Lane Geometry – Year 2023.....27

Figure 12 – Total Traffic Volumes – Year 2041.....28

Figure 13 – Total Traffic Intersection Lane Geometry – Year 2041.....29

List of Tables

Page

Table 1 – Intersection Capacity Analysis Summary – Existing Traffic.....10

Table 2 – Intersection Capacity Analysis Summary – Background Traffic – Year 2023.....18

Table 3 – Intersection Capacity Analysis Summary – Background Traffic – Year 2041.....20

Table 4 – Trip Generation Rates.....22

Table 5 – Trip Generation Summary.....22

Table 6 – Intersection Capacity Analysis Summary – Total Traffic – Year 2023.....31

Table 7 – Intersection Capacity Analysis Summary – Total Traffic – Year 2041.....32

Table 8 – Additional Intersection Capacity Analysis Summary – Total Traffic – Year 2041.....35

Appendices

APPENDIX A TRAFFIC COUNT DATA

 SIGNAL TIMING INFORMATION

APPENDIX B LEVEL OF SERVICE DEFINITIONS

APPENDIX C CAPACITY WORKSHEETS

APPENDIX D CAPACITY WORKSHEETS – E ALLEN STREET & ALEXANDER PLACE

I. Introduction

Project Overview

This traffic impact study addresses the capacity, geometric, and control requirements associated with the development entitled Alexander Way Residential.

This traffic impact study has been revised to address Town review comments made to the previous Alexander Way Residential traffic impact study, dated August 2022, regarding annual growth rates, mitigation for poor intersection level of service and vehicle queuing results, and updates to applicable study figures and tables throughout.

This proposed development consists of single-family and duplex residential land uses. The development is located near the northeast corner of Alexander Place and Brewer Court in unincorporated Douglas County, Colorado. It is understood the development area will be annexed into the Town of Castle Rock in the future.

Study Area Boundaries

The study area to be examined in this analysis encompasses the E Allen Street intersections with Alexander Place, Allen Way, and Front Street, the Founders Parkway intersections with Allen Way, Front Street, and Interstate 25 northbound on/off ramps, and the Alexander Place with Brewer Court intersection.

Figure 1 illustrates location of the site and study intersections.

Site Description

Land for the development is currently vacant and surrounded by a mix of open space, residential, retail, and commercial land uses.

The proposed development is understood to entail the new construction of 55 single-family detached homes and 22 duplex units.

Proposed access to the development is provided by extensions of Brewer Court north of Alexander Place and Alexander Place east of Brewer Court.

It is anticipated that total build-out of development construction would not be completed until at least Year 2028 or 2031 (7 to 10 years). However, for purposes of this study, it is assumed that development construction would be completed by end of Year 2023.

A conceptual site plan, as prepared by Henry Design Group, Inc., is shown on Figure 2. This plan is provided for illustrative purposes.

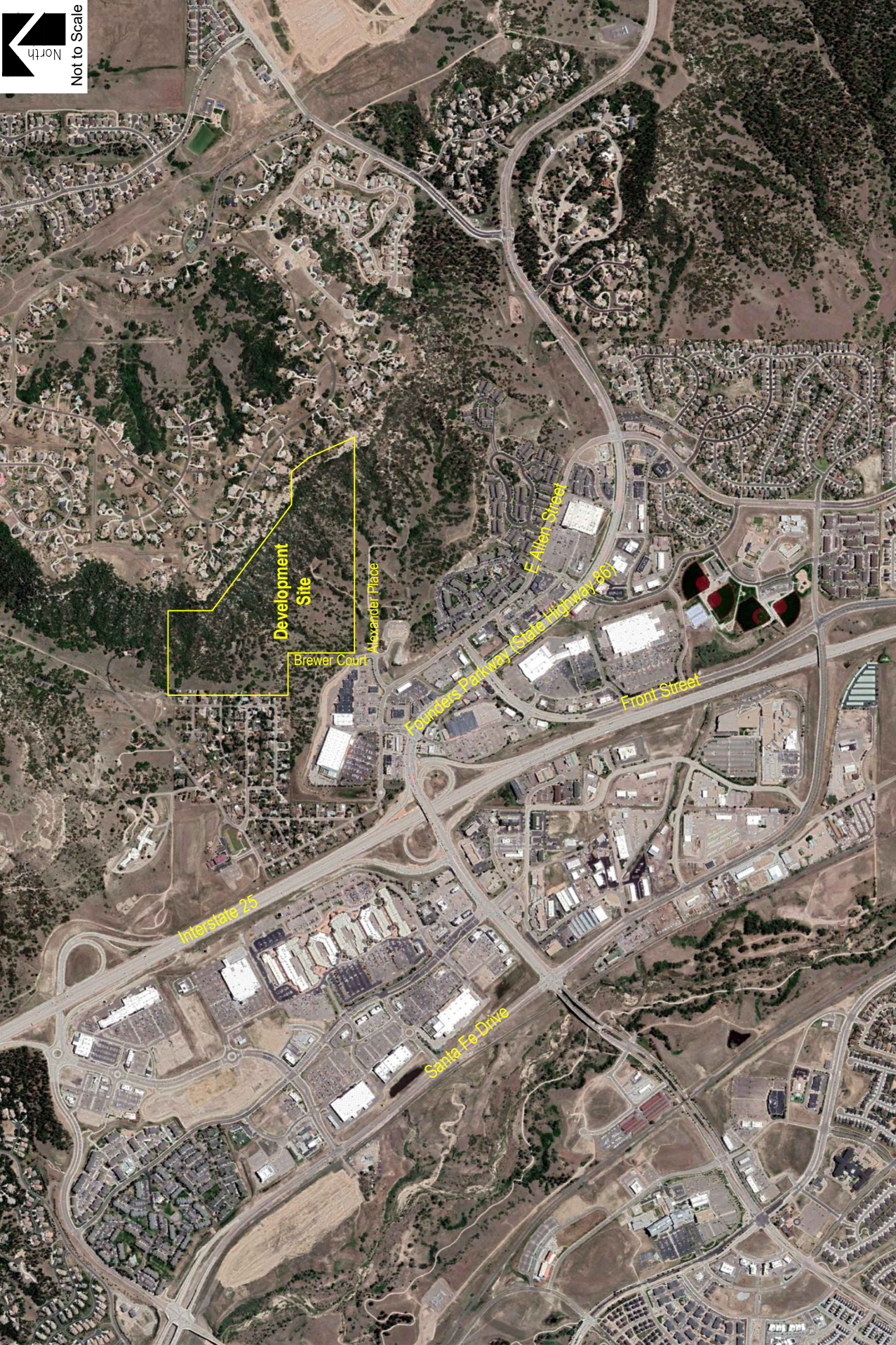

ALEXANDER WAY RESIDENTIAL
Traffic Impact Study

SM ROCHA, LLC
Traffic and Transportation Consultants

Figure 1
SITE LOCATION



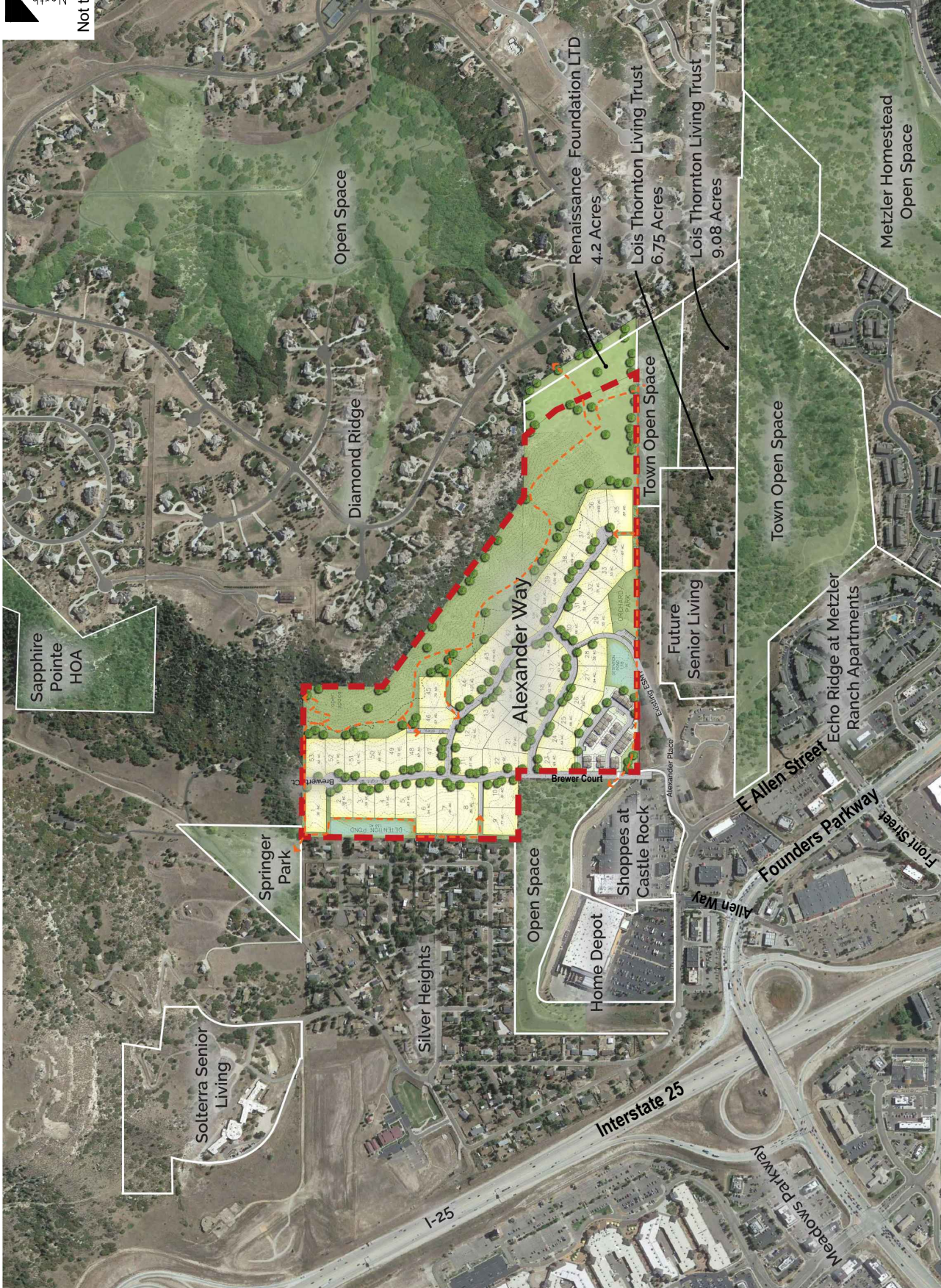

ALEXANDER WAY RESIDENTIAL
Traffic Impact Study

Figure 2
SITE PLAN

SM ROCHA, LLC
Traffic and Transportation Consultants



Existing and Committed Surface Transportation Network

Within the study area, Alexander Place and Brewer Court are the primary roadways that will accommodate traffic to and from the proposed development. Secondary roadways include E Allen Street, Allen Way, Front Street, and Founders Parkway. Referencing the Town's Transportation Master Plan¹, a brief description of each roadway is provided below:

Alexander Place is an east-west local roadway having two through lanes (one lane in each direction) with a combination of shared and exclusive turn lanes at the intersections within the study area and a posted speed limit of 25 MPH. Currently, Alexander Place is an unpaved roadway east of Brewer Court.

Brewer Court is a north-south local roadway having two through lanes (one lane in each direction) with shared turn lanes at the intersection within the study area. Brewer Court does not provide a posted speed limit. However, per Table 2.2 of Town's Design Criteria Manual², Brewer Court is assumed to have a posted speed limit of 25 MPH.

Founders Parkway is generally an east-west state roadway having six through lanes (three lanes in each direction) with a combination of shared and exclusive turn lanes at the intersections within study area. The Colorado Department of Transportation (CDOT) categorizes the adjacent segment of Founders Parkway (State Highway 86) as a Regional Highway (R-A) and provides a posted speed limit of 35 MPH. Founders Parkway ends at Interstate 25 and continues west as Meadows Parkway.

Front Street is generally a north-south roadway classified as a major arterial. Front Street has four through lanes (two lanes in each direction) with a combination of shared and exclusive turn lanes at the intersections within study area and provides a posted speed limit of 40 MPH.

E Allen Street is generally an east-west roadway having two through lanes (one lane in each direction) with a combination of shared and exclusive turn lanes at the intersections within study area. E Allen Street is classified as a collector roadway and provides a posted speed limit of 30 MPH.

Allen Way is a north-south collector roadway having a variation of two to four through lanes (one to two lanes in each direction) with a combination of shared and exclusive turn lanes at the intersections within study area. Allen Way provides a posted speed limit of 25 MPH.

Interstate 25 at Founders Parkway is an existing partial cloverleaf (type B) interchange with Interstate 25 travel below Founders Parkway. The Northbound off ramp has a posted advisory speed limit of 40 MPH. Both interchange ramps have one travel lane with a combination of shared and exclusive turn lanes at Founders Parkway.

¹ Town of Castle Rock Transportation Master Plan, Felsburg Holt & Ullevig, October 2017.

² Town of Castle Rock Transportation Design Criteria Manual, Town of Castle Rock, December 2018.

The study intersections of Founders Parkway with Allen Way, Front Street, and the Interstate 25 northbound on/off ramps, as well as the Allen Way and E Allen Street intersection, are signalized. All other study intersections operate under a stop-controlled condition. A stop-controlled intersection is defined as a roadway intersection where vehicle rights-of-way are controlled by one or more “STOP” signs.

No regional or specific improvements for roadways described above are known to be planned or committed at this time. The study area roadways appear to be built to their ultimate cross-sections.

II. Existing Traffic Conditions

Morning (AM) and afternoon (PM) weekday peak hour traffic counts, as well as Saturday peak hour traffic counts, were collected at the E Allen Street intersections with Alexander Place, Allen Way, and Front Street, the intersection of Alexander Place with Brewer Court, and at the Founders Parkway intersections with Interstate 25 northbound on/off ramps, Allen Way, and Front Street. Average daily (24-hour) traffic volumes were collected on E Allen Street and on Founders Parkway. These counts, along with intersection lane geometry, are shown on Figures 3 and 4.

Traffic count data is included for reference in Appendix A.

Existing signal timing parameters for E Allen Street and Allen Way were obtained from Town Staff, while signal timing parameters along Founders Parkway were obtained from CDOT Staff. Signal timing data was used throughout this study to the best extent possible in order to remain consistent with existing signal coordination plans. Town and CDOT signal timing information received is included for reference in Appendix A.

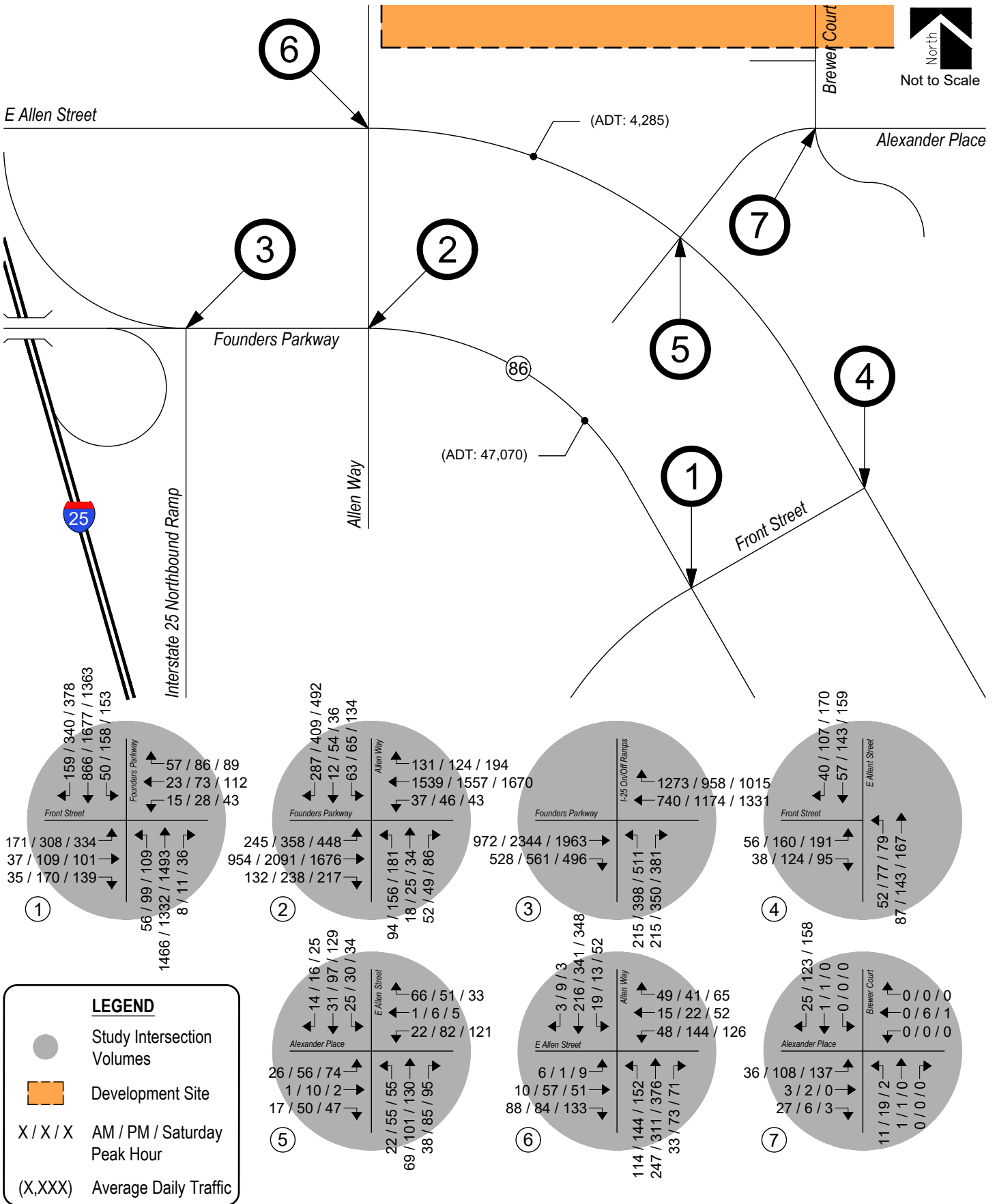
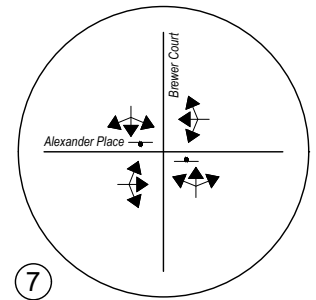
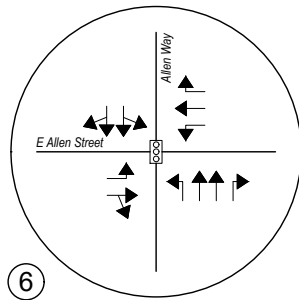
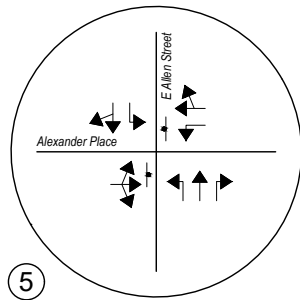
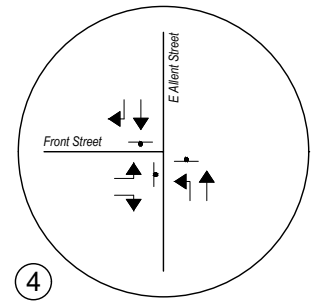
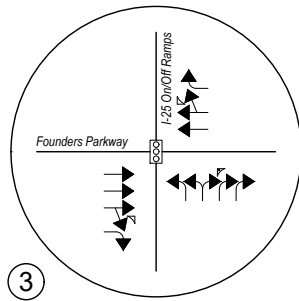
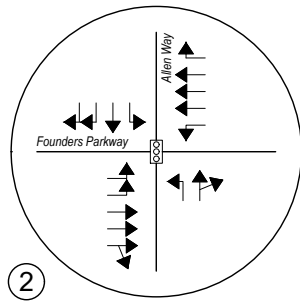
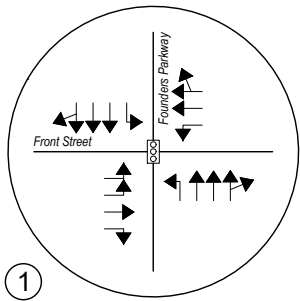
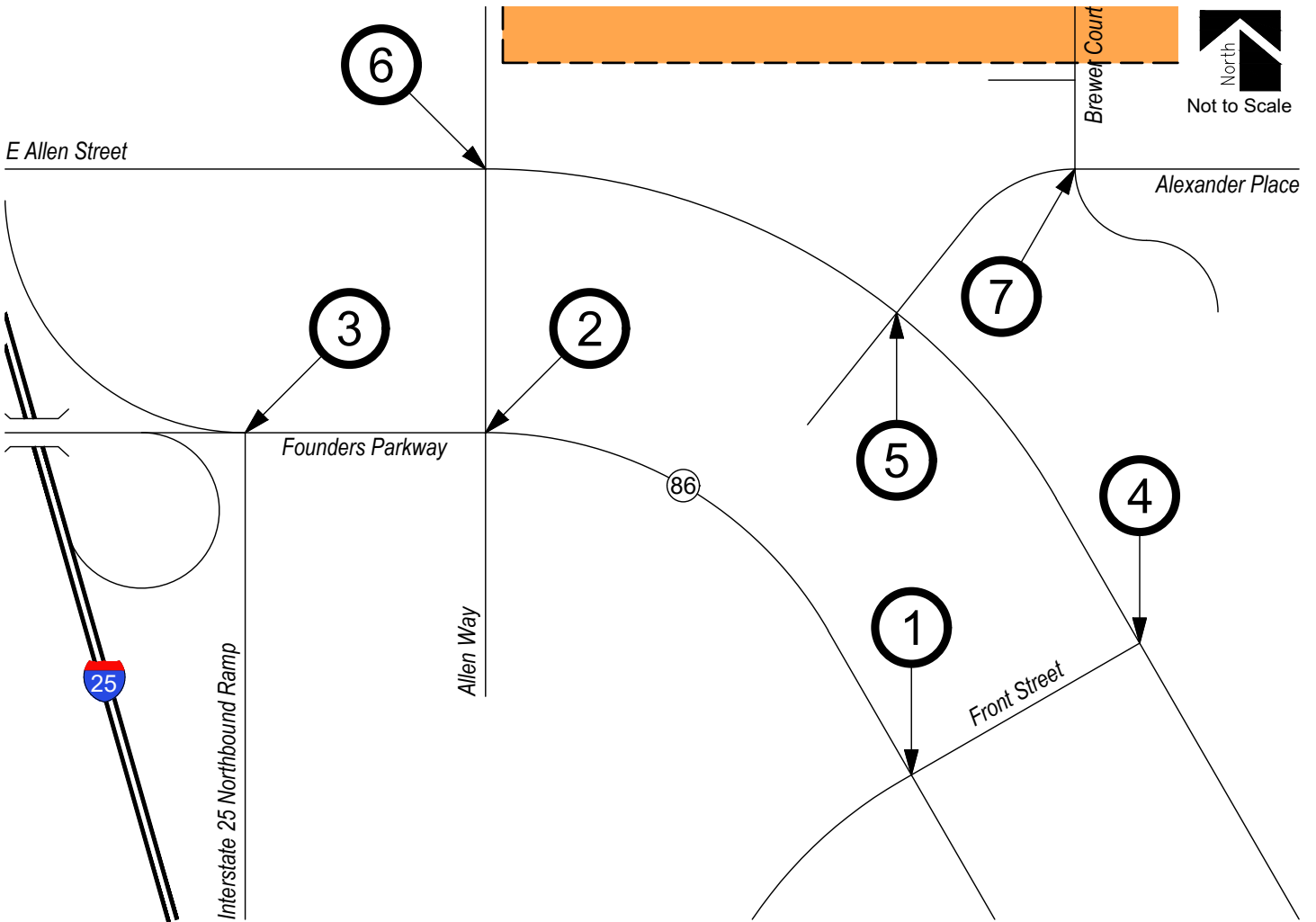

Figure 3
EXISTING TRAFFIC Volumes



LEGEND



-  Study Intersection Lane Geometry
-  Development Site



Figure 4
EXISTING TRAFFIC
Intersection Geometry

The Signalized and Unsignalized Intersection Analysis techniques, as published in the Highway Capacity Manual (HCM) by the Transportation Research Board and as incorporated into the SYNCHRO computer program, were used to analyze the study intersections for existing traffic conditions. These nationally accepted techniques allow for the determination of intersection level of service (LOS) based on the congestion and delay of each traffic movement.

Level of service is a method of measurement used by transportation professionals to quantify a driver's perception of travel conditions that include travel time, number of stops, and total amount of stopped delay experienced on a roadway network. The HCM categorizes level of service into a range from "A" which indicates little, if any, vehicle delay, to "F" which indicates a level of operation considered unacceptable to most drivers. These levels of service grades with brief descriptions of the operating condition, for unsignalized and signalized intersections, are included for reference in Appendix B and have been used throughout this study.

The level of service analyses results for existing conditions are summarized in Table 1. At signalized intersections, the number in parentheses indicates average delay, in seconds per vehicle.

Intersection capacity worksheets developed for this study are provided in Appendix C.

Table 1 – Intersection Capacity Analysis Summary – Existing Traffic

INTERSECTION LANE GROUPS	LEVEL OF SERVICE		
	AM PEAK HOUR	PM PEAK HOUR	SATURDAY PEAK
Founders Parkway / Front Street (Signalized)	B (13.2)	C (21.8)	C (22.9)
Eastbound Left	D (49.7)	E (77.7)	D (38.8)
Eastbound Right	A (0.7)	B (19.6)	A (5.1)
Westbound Left	D (41.3)	D (37.4)	C (29.3)
Westbound Through and Right	C (22.6)	D (37.4)	C (27.4)
Northbound Left	A (5.5)	D (46.1)	C (26.2)
Northbound Through and Right	B (11.0)	B (13.2)	C (20.9)
Southbound Left	A (6.9)	B (14.1)	C (32.9)
Southbound Through and Right	A (9.0)	B (14.4)	C (20.1)
Founders Parkway / Allen Way (Signalized)	C (23.2)	C (23.4)	C (27.9)
Eastbound Left	E (62.4)	E (75.3)	E (62.6)
Eastbound Through and Right	B (19.0)	B (12.7)	C (20.8)
Westbound Left	B (16.1)	C (33.2)	C (29.9)
Westbound Right	A (2.9)	A (2.4)	A (3.4)
Northbound Left	D (43.5)	E (65.9)	D (40.8)
Northbound Through and Right	C (24.6)	C (28.8)	C (29.3)
Southbound Left	D (44.5)	D (48.7)	D (36.9)
Southbound Right	B (18.7)	C (29.8)	B (13.7)
Founders Parkway / I-25 NB Ramps (Signalized)	A (7.3)	B (13.9)	B (17.6)
Eastbound Right	A (0.5)	A (0.9)	A (0.7)
Westbound Right	A (3.4)	A (2.4)	A (3.7)
Northbound Left	E (57.2)	D (53.4)	D (42.6)
Northbound Right	A (8.7)	D (52.4)	D (39.2)
E Allen Street / Allen Way (Signalized)	A (5.5)	B (12.6)	A (9.9)
Eastbound Left	B (16.7)	B (14.0)	B (14.9)
Eastbound Through and Right	A (7.6)	A (9.4)	A (8.4)
Westbound Left	C (27.5)	D (35.5)	D (37.2)
Westbound Right	A (0.7)	A (0.4)	A (0.7)
Northbound Left	A (3.8)	B (16.4)	A (9.2)
Northbound Right	A (0.0)	A (3.8)	A (0.1)
Southbound Left, Through and Right	A (5.0)	A (6.9)	A (6.9)
E Allen Street / Alexander Place (Two-Way Stop-Controlled)			
Eastbound Left, Through and Right	B	B	B
Westbound Left	B	B	C
Westbound Through and Right	A	A	A
Northbound Left	A	A	A
Southbound Left	A	A	A
E Allen Street / Front Street (Two-Way Stop-Controlled)			
Eastbound Left	A	B	B
Eastbound Right	A	A	A
Northbound Left	A	A	B
Northbound Through	A	B	B
Southbound Through	A	B	B
Southbound Right	A	A	A
Alexander Place / Brewer Court (Two-Way Stop-Controlled)			
Eastbound Left, Through and Right	A	A	A
Westbound Left, Through and Right	A	A	A
Northbound Left, Through and Right	A	B	B
Southbound Left, Through and Right	A	A	A

Key: Signalized Intersection: Level of Service (Control Delay in sec/veh)
 Stop-Controlled Intersection: Level of Service

Existing Traffic Analysis Results

Under existing conditions, operational analysis shows that the signalized intersection of Founders Parkway with Front Street has overall operations at LOS B during the morning peak traffic hour and LOS C during the afternoon and Saturday peak traffic hours.

The signalized intersection of Founders Parkway with Allen Way has overall operations at LOS C during morning, afternoon, and Saturday peak traffic hours.

The signalized intersection of Founders Parkway with Interstate 25 northbound on/off ramp shows intersection operations at LOS A during the morning peak traffic hour and LOS B during both the afternoon and Saturday peak traffic hours.

The signalized intersection with E Allen Street with Allen Way has overall operations at LOS A during the morning and Saturday peak traffic hours, while the afternoon peak traffic hour has overall LOS B operations.

The stop-controlled intersection of E Allen Street with Alexander Place has turn movement operations at or better than LOS B during both the morning and afternoon peak traffic hours, and LOS C or better during the Saturday peak traffic hour.

The stop-controlled intersection of E Allen Street with Front Street shows movement operations at LOS A during the morning peak traffic hour and LOS B or better during both the afternoon and Saturday peak traffic hours.

The stop-controlled intersection of Alexander Place with Brewer Court has turn movement operations at LOS A during the morning peak traffic hour and LOS B or better during afternoon and Saturday peak traffic hours.

III. Future Traffic Conditions Without Proposed Development

Background traffic is the traffic projected to be on area roadways without consideration of the proposed development. Background traffic includes traffic generated by development of vacant parcels in the area.

To account for projected increases in background traffic for Years 2023 and 2041, a compounded annual growth rate was determined using traffic data provided by CDOT's Online Transportation Information System (OTIS), which anticipates a 20-year growth rate less than one percent along the adjacent segment of Founders Parkway (State Highway 86). However, in coordination with Town Staff and to provide for a conservative analysis, a growth rate of two percent was applied to existing traffic volumes.

To account for projected traffic from adjacent developments not yet built, trip generations from the Alexander Place Senior Living Traffic Impact Study³ were added to background traffic volumes.

Pursuant to the non-committed area roadway improvements discussed in Section I, Year 2023 and Year 2041 background traffic conditions assume no roadway improvements to accommodate regional transportation demands. This assumption provides for a conservative analysis.

Pursuant to conversation with Town Staff, the signalized intersections along Founders Parkway will be implemented with adaptive signal control systems. As such, signal timings will be subject to change throughout peak traffic hours which cannot accurately be modeled within the SYNCHRO computer program used within this analysis. Moreover, it is unknown when these improvements along the Founders Parkway corridor will occur. Therefore, Year 2023 and 2041 background traffic conditions assume no improvements to signal timing optimization. This provides a conservative analysis since actual signal timing parameters and operations for Year 2041 background conditions with adaptive signal control are likely better than the level of service values provided within this report.

Projected background traffic volumes and intersection geometry for Year 2023 are shown on Figure 5 and 6, respectively.

Year 2041 projected background traffic volumes and intersection geometry are shown on Figure 7 and Figure 8, respectively.

³ Alexander Place Senior Living: Traffic Impact Study, SM ROCHA, LLC, August 2019.

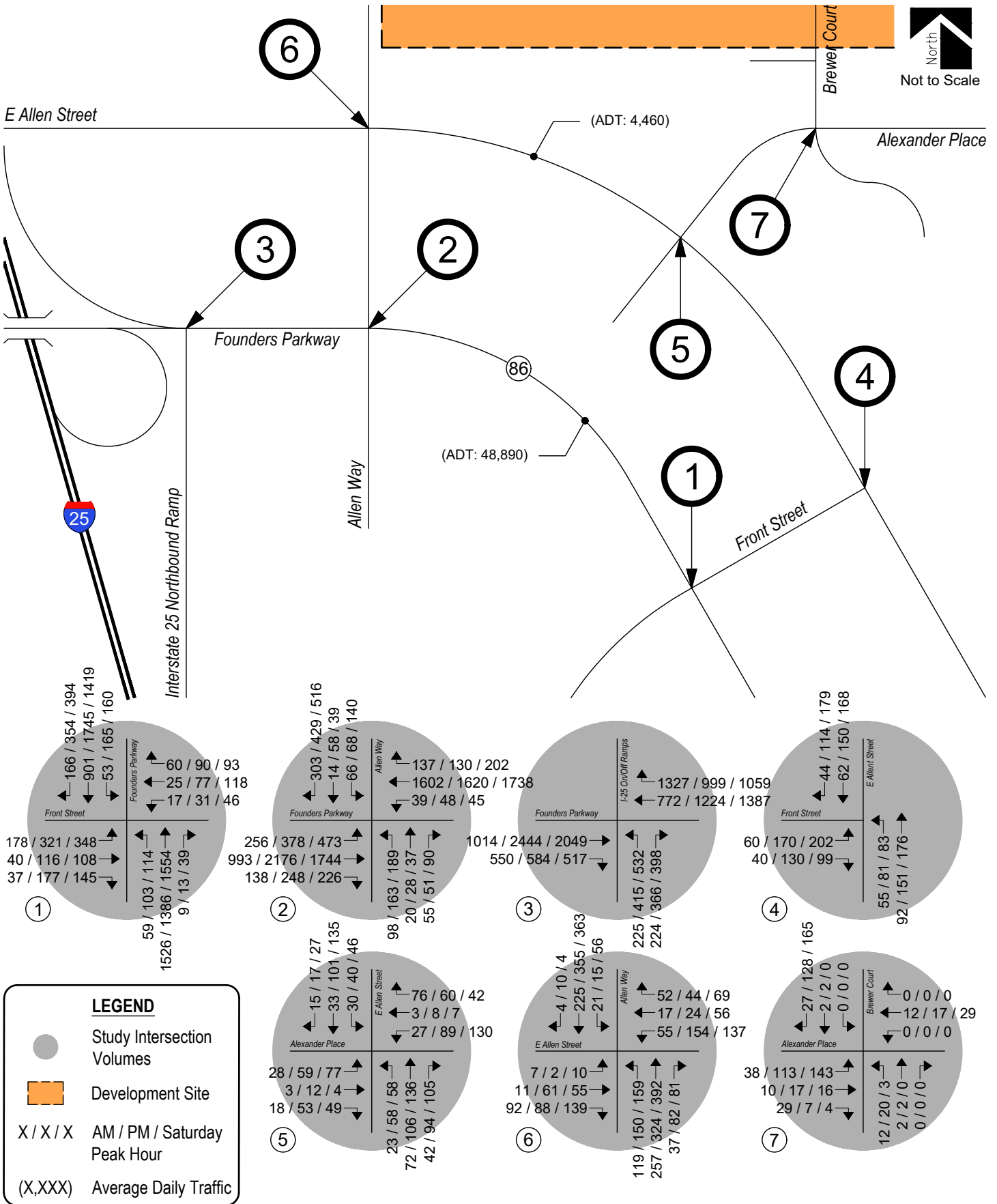
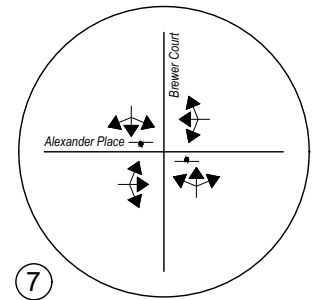
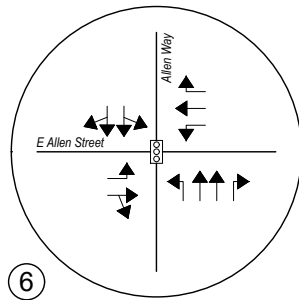
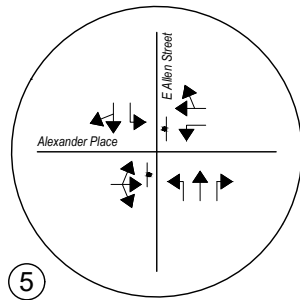
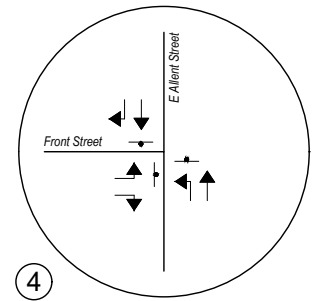
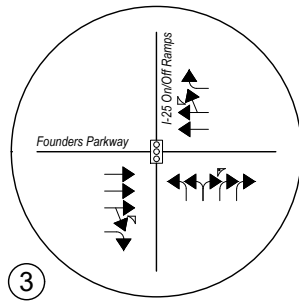
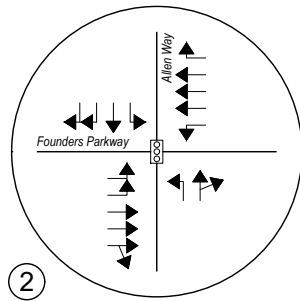
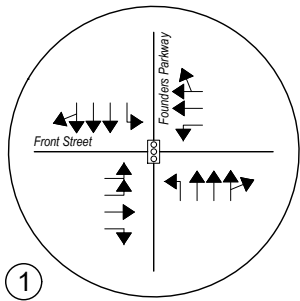
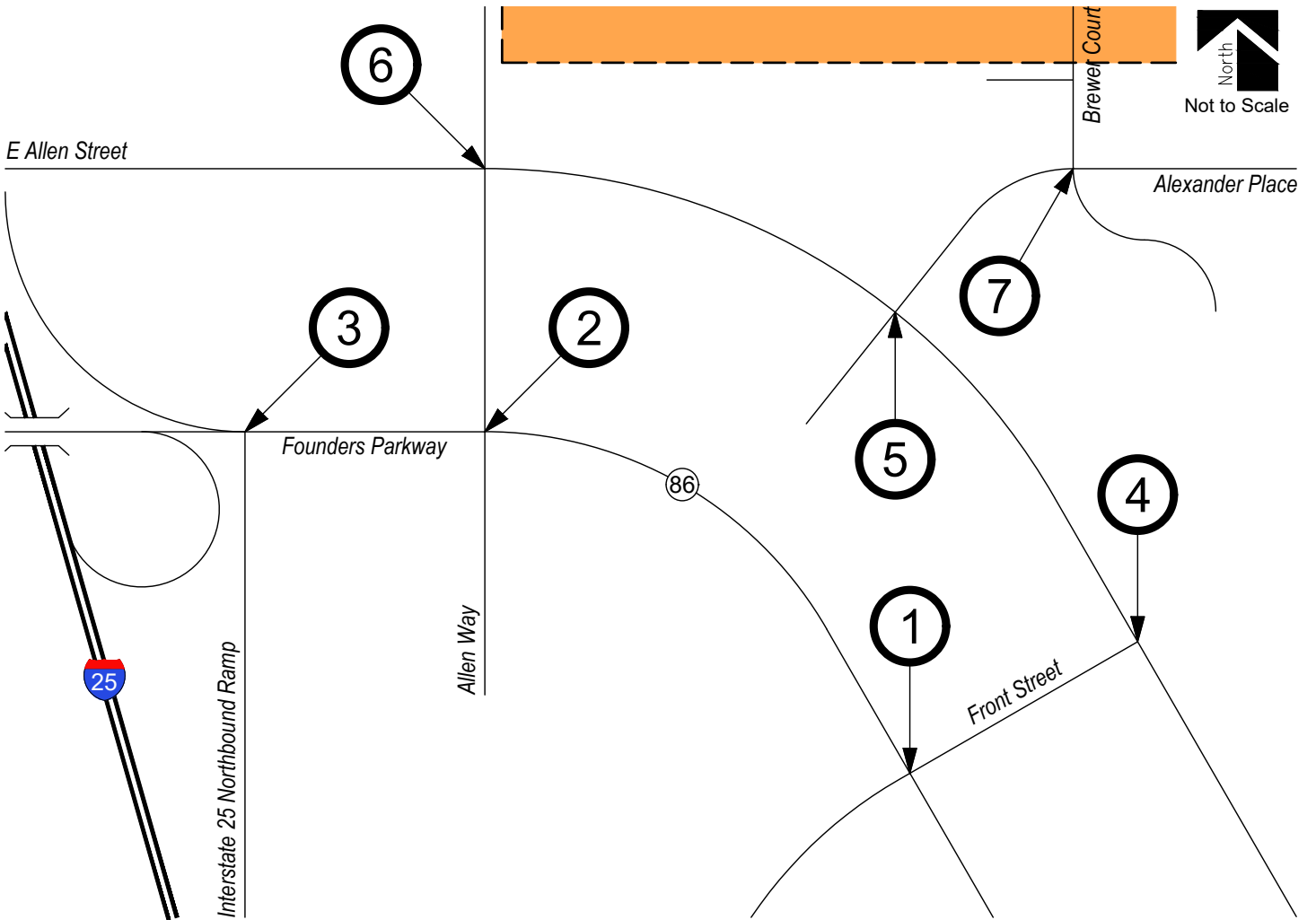

Figure 5
BACKGROUND TRAFFIC - YEAR 2023
 Volumes



LEGEND

- Study Intersection Lane Geometry
- Development Site



Figure 6
BACKGROUND TRAFFIC - YEAR 2023
 Intersection Geometry

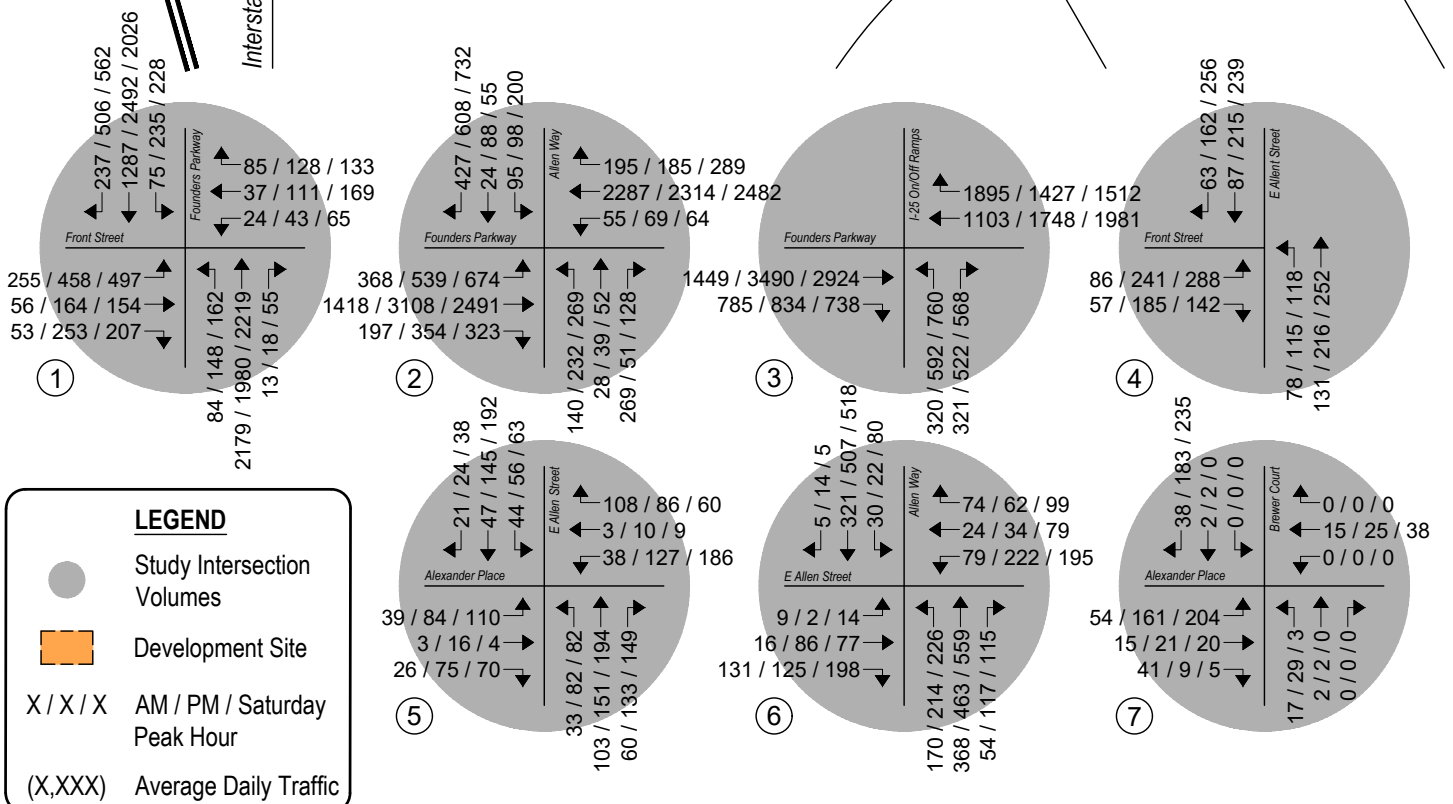
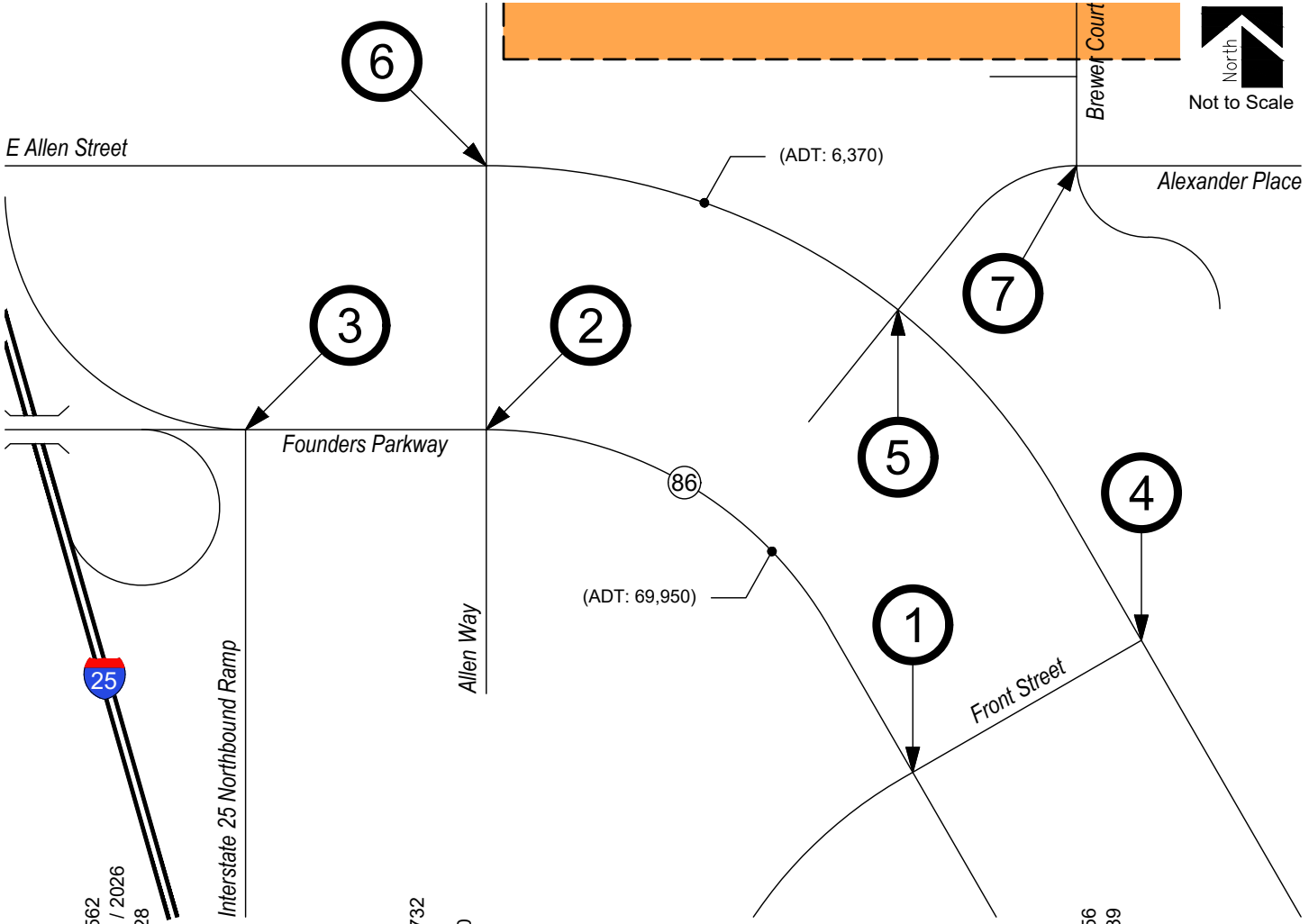

LEGEND

- Study Intersection Volumes
- Development Site
- X / X / X AM / PM / Saturday Peak Hour
- (X,XXX) Average Daily Traffic

Figure 7
BACKGROUND TRAFFIC - YEAR 2041
 Volumes

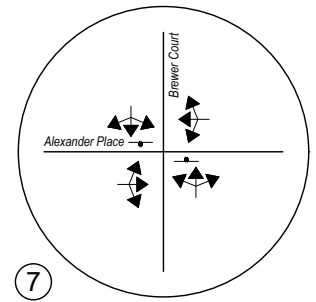
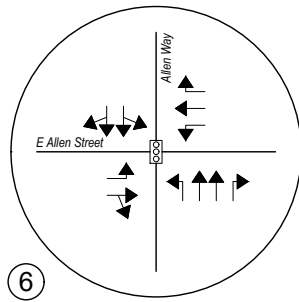
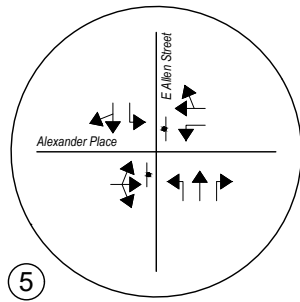
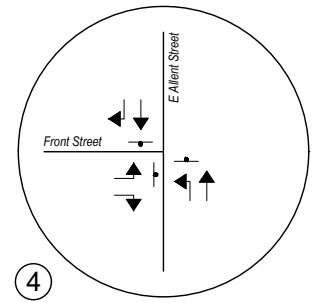
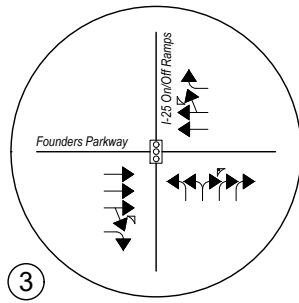
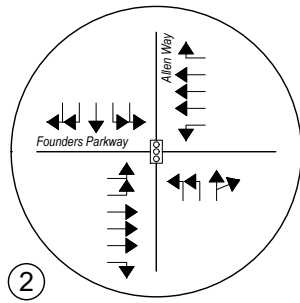
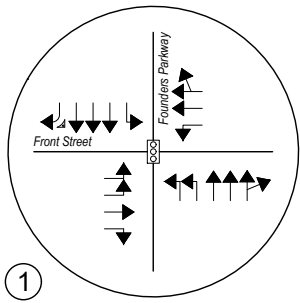
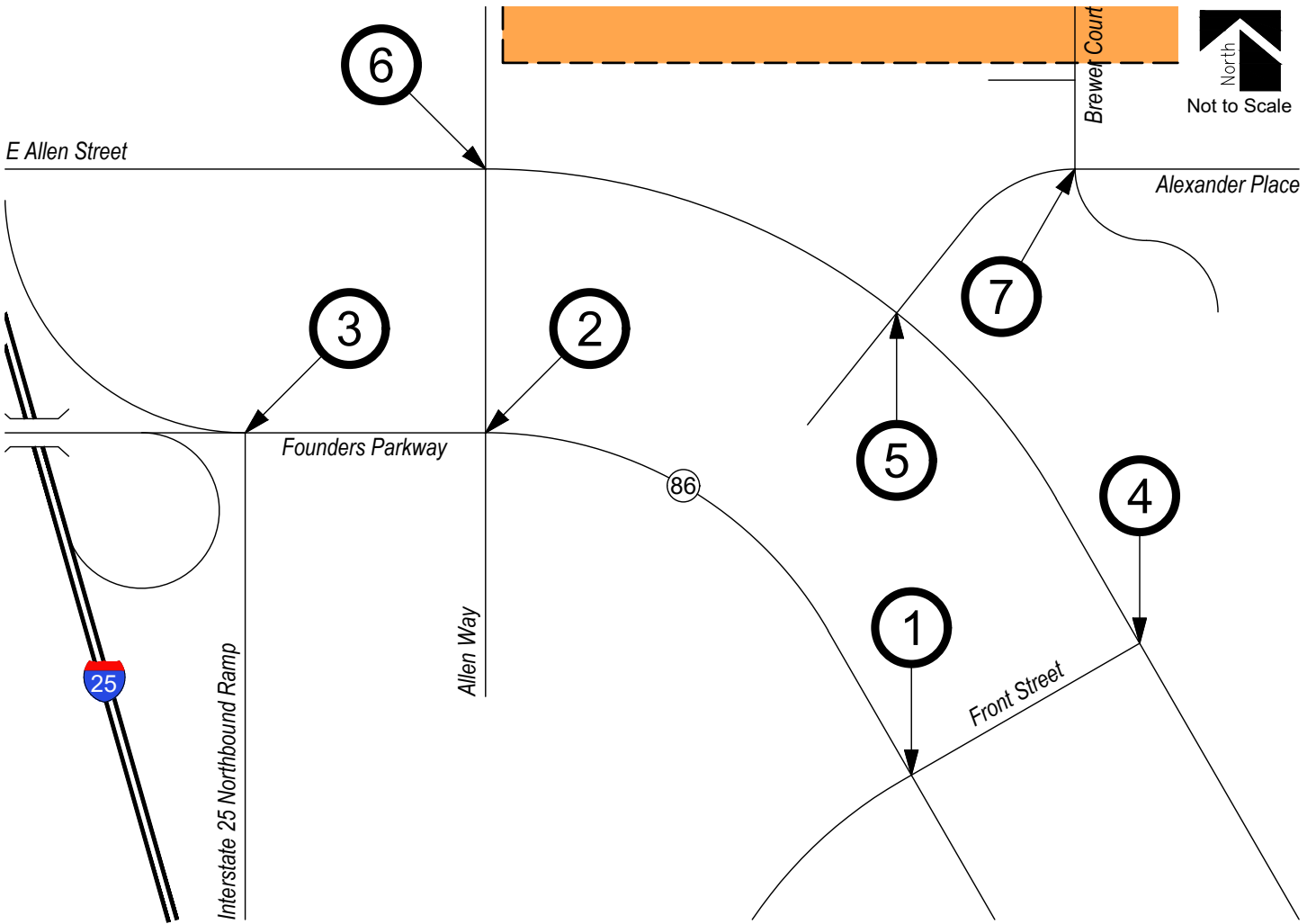

LEGEND

- Study Intersection Lane Geometry
- Development Site



Figure 8
BACKGROUND TRAFFIC - YEAR 2041
 Intersection Geometry

As with existing traffic conditions, the operations of study intersections were analyzed under background conditions, without the proposed development, using the SYNCHRO computer program.

Background traffic level of service analysis results for Year 2023 are listed in Table 2. Year 2041 operational results are summarized in Table 3. At signalized intersections, the number in parentheses indicates average delay, in seconds per vehicle.

Definitions of levels of service are given in Appendix B. Intersection capacity worksheets are provided in Appendix C.

Table 2 – Intersection Capacity Analysis Summary – Background Traffic – Year 2023

INTERSECTION LANE GROUPS	LEVEL OF SERVICE		
	AM PEAK HOUR	PM PEAK HOUR	SATURDAY PEAK
Founders Parkway / Front Street (Signalized)	B (13.5)	C (23.5)	C (24.1)
Eastbound Left	D (50.1)	F (87.9)	D (39.3)
Eastbound Right	A (0.87)	C (22.5)	A (6.2)
Westbound Left	D (41.2)	D (44.5)	C (29.1)
Westbound Through and Right	C (22.5)	D (38.3)	C (27.3)
Northbound Left	A (5.8)	D (47.7)	C (28.1)
Northbound Through and Right	B (11.3)	B (13.9)	C (22.1)
Southbound Left	A (7.6)	B (17.4)	D (35.0)
Southbound Through and Right	A (9.2)	B (15.1)	C (21.5)
Founders Parkway / Allen Way (Signalized)	C (23.8)	C (25.0)	C (32.3)
Eastbound Left	E (62.6)	E (79.8)	E (63.3)
Eastbound Through and Right	B (18.8)	B (13.4)	C (22.6)
Westbound Left	B (15.8)	C (33.9)	C (30.3)
Westbound Right	A (2.6)	A (2.3)	A (3.4)
Northbound Left	D (44.9)	E (75.3)	D (41.7)
Northbound Through and Right	C (26.5)	C (30.4)	C (31.6)
Southbound Left	D (44.7)	D (50.3)	D (37.8)
Southbound Right	C (23.2)	D (37.5)	B (17.3)
Founders Parkway / I-25 NB Ramps (Signalized)	A (7.3)	B (14.6)	C (27.8)
Eastbound Through and Right	A (0.5)	A (1.0)	A (0.8)
Westbound Through and Right	A (3.6)	A (2.6)	A (3.8)
Northbound Left	E (57.2)	D (52.6)	D (42.7)
Northbound Right	A (9.6)	D (52.2)	F (94.1)
E Allen Street / Allen Way (Signalized)	A (5.8)	B (12.8)	B (10.2)
Eastbound Left	B (16.4)	B (13.5)	B (14.5)
Eastbound Through and Right	A (7.5)	A (9.2)	A (8.2)
Westbound Left	C (28.0)	D (35.8)	D (37.4)
Westbound Right	A (0.7)	A (0.4)	A (0.7)
Northbound Left	A (4.1)	B (17.0)	A (10.0)
Northbound Right	A (0.1)	A (4.2)	A (0.2)
Southbound Left, Through and Right	A (5.2)	A (7.2)	A (7.3)
E Allen Street / Alexander Place (Two-Way Stop-Controlled)			
Eastbound Left, Through and Right	B	A	C
Westbound Left	B	C	C
Westbound Through and Right	A	A	B
Northbound Left	A	A	A
Southbound Left	A	A	A
E Allen Street / Front Street (All-Way Stop-Controlled)			
Eastbound Left	A	B	B
Eastbound Right	A	A	A
Northbound Left	A	B	B
Northbound Through	A	B	B
Southbound Through	A	B	B
Southbound Right	A	A	B
Alexander Place / Brewer Court (Two-Way Stop-Controlled)			
Eastbound Left, Through and Right	A	A	A
Westbound Left, Through and Right	A	A	A
Northbound Left, Through and Right	A	B	B
Southbound Left, Through and Right	A	A	A

Key: Signalized Intersection: Level of Service (Control Delay in sec/veh)
 Stop-Controlled Intersection: Level of Service

Background Traffic Analysis Results – Year 2023

Year 2023 background traffic analysis indicates that the signalized intersection of Founders Parkway with Front Street experiences overall operations at LOS B during the morning peak traffic hour and LOS C during both the afternoon and Saturday peak traffic hours.

The signalized intersection of Founders Parkway with Allen Way predicts overall operations at LOS C during the morning, afternoon, and Saturday peak traffic hours.

The signalized intersection of Founders Parkway with Interstate 25 northbound on/off ramp shows intersection operations at LOS A during the morning peak traffic hour, LOS B during the afternoon peak traffic hour, and LOS C during the Saturday peak traffic hour.

The signalized intersection with E Allen Street with Allen Way has overall operations at LOS A during the morning peak traffic hour and LOS B during the afternoon and Saturday peak traffic hours.

The stop-controlled intersection of E Allen Street with Alexander Place experiences turn movement operations at or better than LOS B during the morning peak traffic hour and LOS C or better during the afternoon and Saturday peak traffic hours.

The stop-controlled intersection of E Allen Street with Front Street shows movement operations at LOS A during the morning peak traffic hour and LOS B or better during the afternoon and Saturday peak traffic hours.

The stop-controlled intersection of Alexander Place with Brewer Court has turn movement operations at LOS A during the morning peak traffic hour and LOS B or better during the afternoon and Saturday peak traffic hours.

Table 3 – Intersection Capacity Analysis Summary – Background Traffic – Year 2041

INTERSECTION LANE GROUPS	LEVEL OF SERVICE		
	AM PEAK HOUR	PM PEAK HOUR	SATURDAY PEAK
Founders Parkway / Front Street (Signalized)	B (17.9)	C (32.5)	D (37.9)
Eastbound Left	D (47.6)	E (62.2)	E (67.3)
Eastbound Right	A (1.2)	C (28.7)	B (13.8)
Westbound Left	D (42.2)	D (40.6)	D (37.3)
Westbound Through and Right	C (33.7)	D (38.4)	E (79.6)
Northbound Left	A (6.1)	C (22.7)	B (16.3)
Northbound Through and Right	B (18.4)	C (31.5)	D (48.9)
Southbound Left	C (20.9)	E (62.1)	E (61.6)
Southbound Right	A (1.6)	A (4.7)	A (6.4)
Founders Parkway / Allen Way (Signalized)	D (37.3)	D (51.2)	E (78.4)
Eastbound Left	F (83.0)	E (64.8)	F (152.7)
Eastbound Right	A (1.7)	A (5.0)	A (3.3)
Westbound Left	C (22.2)	D (51.1)	D (35.5)
Westbound Right	A (5.8)	A (5.2)	A (4.8)
Northbound Left	D (38.4)	E (56.2)	E (59.6)
Northbound Through and Right	F (91.5)	D (42.9)	F (143.9)
Southbound Left	D (40.2)	D (45.7)	D (43.5)
Southbound Right	B (13.2)	D (45.9)	F (119.5)
Founders Parkway / I-25 NB Ramps (Signalized)	B (17.1)	E (64.4)	E (70.1)
Eastbound Through and Right	A (5.7)	F (83.0)	E (65.5)
Westbound Through and Right	C (23.4)	E (59.2)	F (92.4)
Northbound Left	E (60.9)	F (84.4)	F (129.9)
Northbound Right	D (41.8)	F (132.4)	F (113.5)
E Allen Street / Allen Way (Signalized)	A (6.3)	B (12.3)	B (13.2)
Eastbound Left	B (16.7)	B (13.5)	B (14.5)
Eastbound Through and Right	A (7.5)	A (8.5)	A (7.5)
Westbound Left	C (32.8)	C (34.1)	C (34.9)
Westbound Right	A (1.0)	A (0.3)	A (0.6)
Northbound Left	A (5.0)	C (22.8)	C (27.6)
Northbound Right	A (0.1)	A (0.3)	A (0.5)
Southbound Left, Through and Right	A (5.3)	A (9.9)	B (10.7)
E Allen Street / Alexander Place (Two-Way Stop-Controlled)			
Eastbound Left, Through and Right	B	C	E
Westbound Left	B	D	F
Westbound Through and Right	A	B	B
Northbound Left	A	A	A
Southbound Left	A	A	A
E Allen Street / Front Street (All-Way Stop-Controlled)			
Eastbound Left	A	B	B
Eastbound Right	A	B	C
Northbound Left	A	C	C
Northbound Through	A	B	B
Southbound Through	A	B	C
Southbound Right	A	B	B
Alexander Place / Brewer Court (Two-Way Stop-Controlled)			
Eastbound Left, Through and Right	A	A	A
Westbound Left, Through and Right	A	A	A
Northbound Left, Through and Right	B	C	C
Southbound Left, Through and Right	A	A	A

Key: Signalized Intersection: Level of Service (Control Delay in sec/veh)
 Stop-Controlled Intersection: Level of Service

Background Traffic Analysis Results – Year 2041

By Year 2041 and without the proposed development, the signalized intersection of Founders Parkway with Front Street anticipates overall operations at LOS B, C, and D during the morning, afternoon, and Saturday peak traffic hours, respectively.

The signalized intersection of Founders Parkway with Allen Way projects overall operations at LOS D during the morning peak traffic hour and LOS E during the afternoon and Saturday peak traffic hours. The LOS E operations anticipated during the afternoon and Saturday peak traffic periods is attributed to approach volumes from all directions.

The signalized intersection of Founders Parkway with Interstate 25 northbound on/off ramps experiences intersection operations at LOS B during the morning peak traffic hour and LOS E during the afternoon and Saturday peak traffic hours. The LOS E operations anticipated during the afternoon and Saturday peak traffic periods is attributed to approach volumes from all directions.

The signalized intersection with E Allen Street with Allen Way predicts overall operations at LOS A during the morning peak traffic hour and LOS B during the afternoon and Saturday peak traffic hours.

The stop-controlled intersection of E Allen Street with Alexander Place expects turn movement operations at or better than LOS B during the morning and Saturday peak traffic hours and LOS D or better during the afternoon peak traffic hour. Exceptions would include the eastbound shared movement and westbound left turn movement which operate at LOS E and LOS F, respectively, during the Saturday peak traffic hour. The LOS E and LOS F operations are attributed to the through traffic volume along E Allen Street and the stop-controlled nature of the intersection.

The stop-controlled intersection of E Allen Street with Front Street projects movement operations at LOS A during the morning peak traffic hour and LOS C or better during the afternoon and Saturday peak traffic hours.

The stop-controlled intersection of Alexander Place with Brewer Court anticipates turn movement operations at or better than LOS B during the morning peak traffic hour and LOS C or better during the afternoon and Saturday peak traffic hours.

In order to mitigate the anticipated LOS E and LOS F operations at the signalized intersections of Founders Parkway with Allen Way and Interstate 25 northbound on/off ramps, it is recommended implementing adaptive signal control systems along the Founders Parkway corridor. As previously indicated, Year 2041 background operations are likely better than the results provided within this report as SYNCHRO cannot accurately model the change to signal timings throughout a peak hour.

It is to be noted that it is not uncommon for unsignalized movements to or from an arterial roadway, in urban areas, to operate with noticeable delays during peak traffic hours. It is, however, likely that turn movements will operate better than the results obtained with this HCM Two Way Stop Control (TWSC) level of service analysis would indicate, as the HCM analysis may not accurately account for the effect of vehicle platooning and gaps caused by upstream signals. Upstream signal controls will tend to create additional gaps in the traffic stream for turning movements at Alexander Place and will most likely provide mitigation to the LOS E and F operations projected during the Saturday peak traffic hour.

IV. Proposed Project Traffic

Trip Generation

Standard traffic generation characteristics compiled by the Institute of Transportation Engineers (ITE) in their report entitled Trip Generation Manual, 11th Edition, were applied to the proposed land use in order to estimate average daily traffic (ADT), AM Peak Hour, and PM Peak Hour vehicle trips. A vehicle trip is defined as a one-way vehicle movement from a point of origin to a point of destination.

The ITE land use codes 210 (Single-Family Detached Housing) and 215 (Single-Family Attached Housing) were used for estimating trip generation because of their best fit to the proposed land use description.

It is important to note that the proposed duplex units provide opportunities to accommodate professional services or personal home-based businesses. However, trip generation characteristics are not expected to differ from that reported by ITE land use code 215 (Single-Family Attached Housing) considering how the main land use description remains residential.

Trip generation rates used in this study are presented in Table 4.

Table 4 – Trip Generation Rates

ITE CODE	LAND USE	UNIT	TRIP GENERATION RATES									
			24	AM PEAK HOUR			PM PEAK HOUR			SATURDAY		
			HOUR	ENTER	EXIT	TOTAL	ENTER	EXIT	TOTAL	ENTER	EXIT	TOTAL
210	Single-Family Detached Housing	DU	9.43	0.18	0.52	0.70	0.59	0.35	0.94	0.50	0.42	0.92
215	Single-Family Attached Housing	DU	7.20	0.15	0.33	0.48	0.32	0.25	0.57	0.27	0.30	0.57

Key: DU = Dwelling Units.

* = ITE does not report significant Saturday peak hour generation due to the nature of the business (ie, operating hours typically outside of Saturday peak).

Note: All data and calculations above are subject to being rounded to nearest value.

Table 5 illustrates projected ADT, AM Peak Hour, and PM Peak Hour traffic volumes likely generated by the proposed development upon build-out.

Table 5 – Trip Generation Summary

ITE CODE	LAND USE	SIZE	TOTAL TRIPS GENERATED									
			24	AM PEAK HOUR			PM PEAK HOUR			SATURDAY		
			HOUR	ENTER	EXIT	TOTAL	ENTER	EXIT	TOTAL	ENTER	EXIT	TOTAL
210	Single-Family Detached Housing	55 DU	519	10	28	39	33	19	52	27	23	51
215	Single-Family Attached Housing	22 DU	158	3	7	11	7	5	13	6	7	13
<i>Total:</i>			677	13	36	49	40	25	64	33	30	63

Note: All data and calculations above are subject to being rounded to nearest value.

Upon build-out, Table 5 illustrates that the proposed development has the potential to generate approximately 677 daily trips with 49 of those occurring during the morning peak hour, 64 during the afternoon peak hour, and 63 during the Saturday peak hour.

Adjustments to Trip Generation Rates

A development of this type is not likely to attract trips from within area land uses nor pass-by or diverted link trips from the adjacent roadway system, therefore no trip reduction was taken in this analysis.

Trip Distribution

The overall directional distribution of site-generated traffic was determined based on the location of development site within the Town, proposed and existing area land uses, allowed turning movements, and available roadway network.

Overall trip distribution patterns for the development are shown on Figure 9.

Trip Assignment

Trip assignment is how generated and distributed vehicle trips are expected to be loaded onto the available roadway network.

Applying trip distribution patterns to site-generated traffic provides the overall site-generated trip assignments shown on Figure 9.

Development Impacts

As Table 5 shows, there is an increase in peak hour traffic volumes anticipated for the proposed development and are considered minor. These minor volumes are not likely to negatively impact operations of Founders Parkway, E Allen Street, nor other adjacent roadways or intersections

Comparison of estimated ADT volumes shown in Figure 8 – Background Traffic – Year 2041 with projected 24-hour volumes shown in Table 5 indicate a minor increase in traffic volumes for the surrounding roadway network.

For example, when distributing the estimated 24-hour volume shown in Table 5 onto the adjacent roadway network for Year 2041, approximately one out of every 15 vehicles along E Allen Street is expected to represent the proposed development (or an increase of approximately seven percent to the ADT volume along E Allen Street). Similarly, approximately one out of every 250 vehicles along Founders Parkway is projected to represent the proposed development (or an increase of less than one percent to the ADT volume along Founders Parkway).

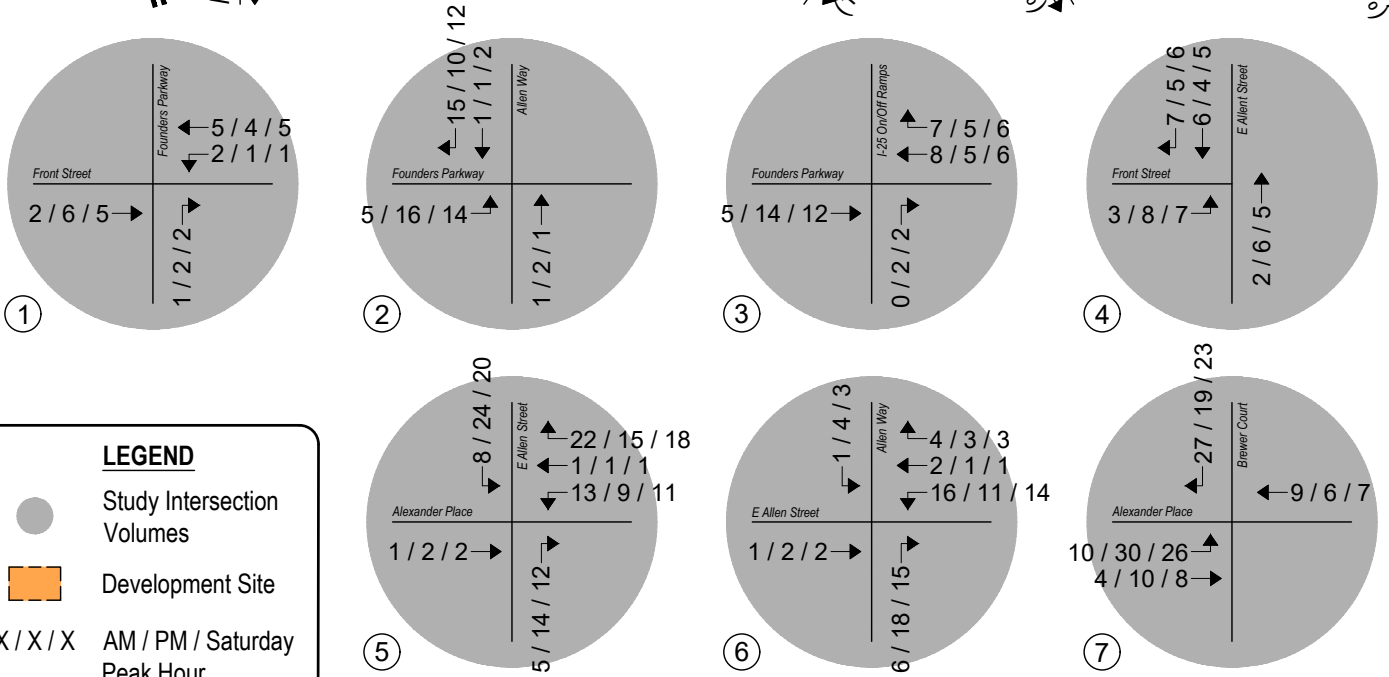
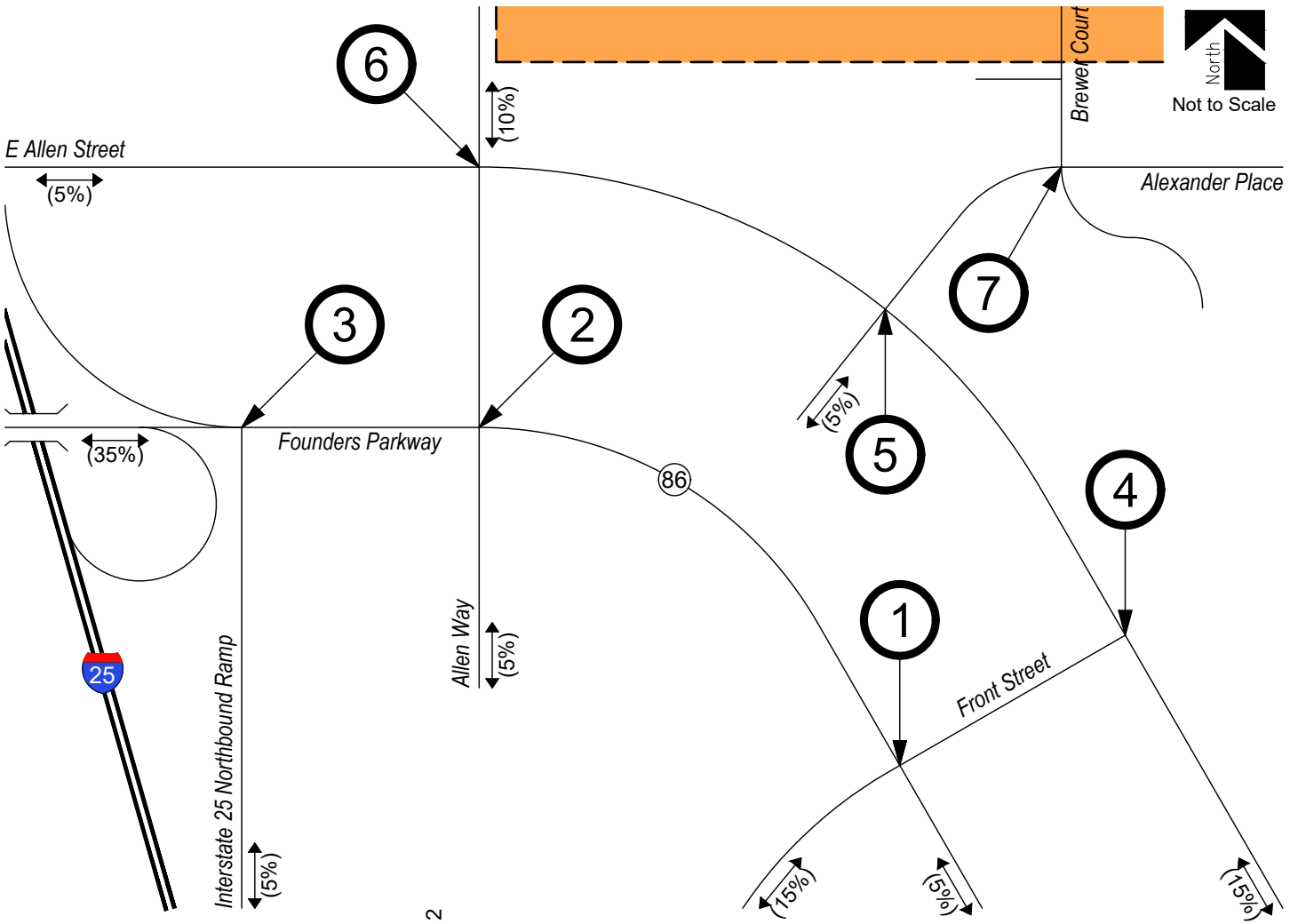

LEGEND

- Study Intersection Volumes
- Development Site
- X / X / X AM / PM / Saturday Peak Hour
- (X,XXX) Average Daily Traffic

Figure 9
SITE DEVELOPMENT DISTRIBUTION
 (%): Overall
SITE-GENERATED
 AM / PM / Saturday Peak Hour

V. Future Traffic Conditions With Proposed Developments

Site-generated traffic was added to background traffic projections for Years 2023 and 2041 to develop total traffic projections. For analysis purposes, it was assumed that development construction would be completed by end of Year 2023.

Pursuant to area roadway improvement discussions provided in Section III, Year 2023 and Year 2041 total traffic conditions assume no additional roadway improvements to accommodate regional transportation demands. Roadway improvements associated with site development are expected to be limited to site access and frontage as required by the governing agency.

As previously mentioned in Section III, the signalized intersections along Founders Parkway are assumed to be implemented with adaptive signal control systems. Therefore, in coordination with Town Staff, signal timing information for total traffic conditions was reoptimized.

Projected Year 2023 total traffic volumes and intersection geometry are shown in Figure 10 and Figure 11, respectively.

Figure 12 and Figure 13 show projected total traffic volumes and intersection geometry for Year 2041, respectively.

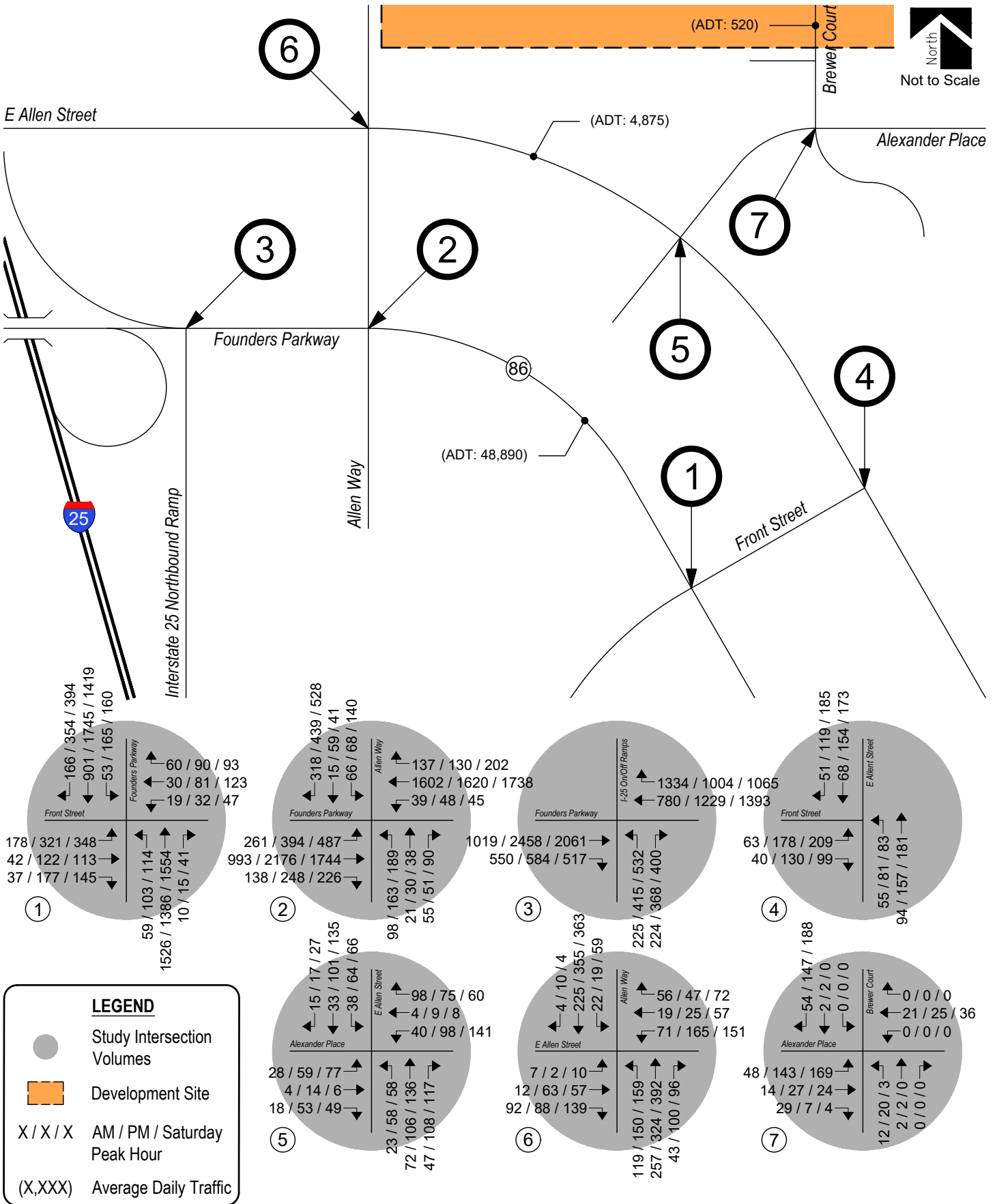
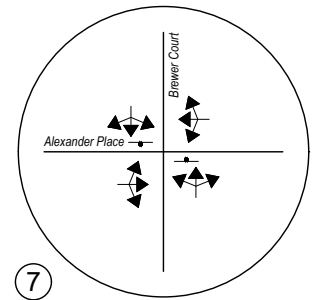
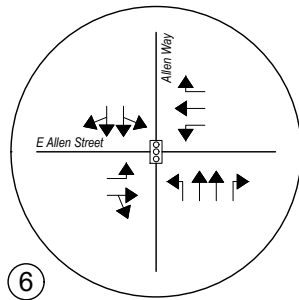
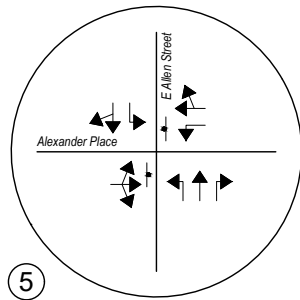
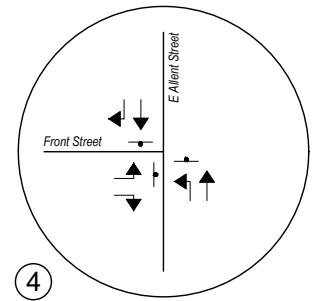
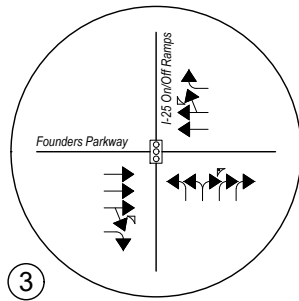
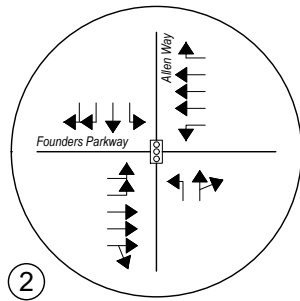
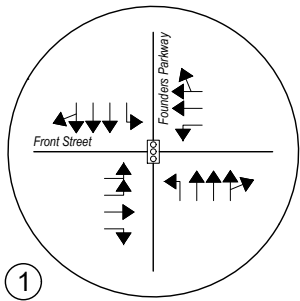
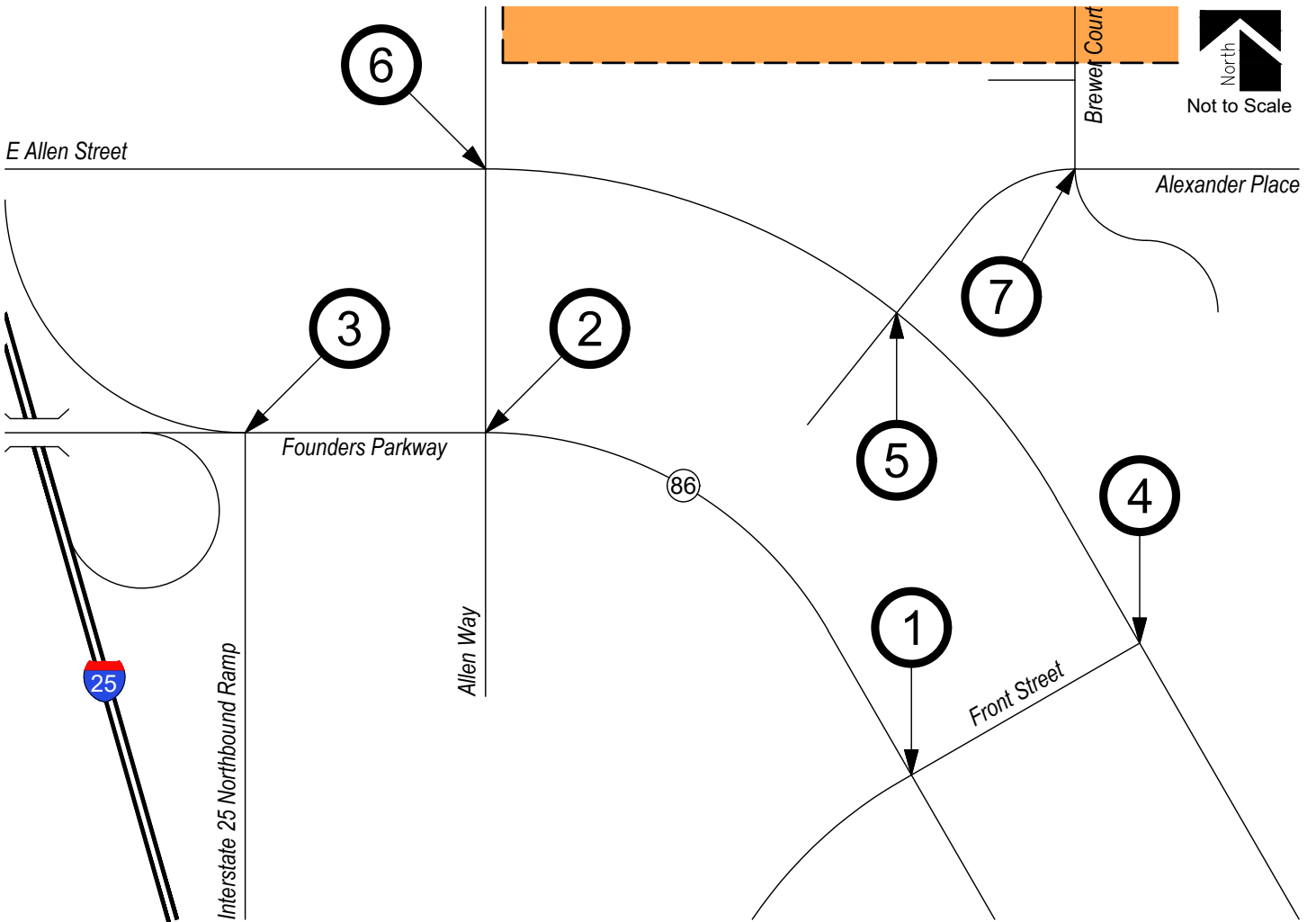

Figure 10
TOTAL TRAFFIC - YEAR 2023
 Volumes



LEGEND

- Study Intersection Lane Geometry
- Development Site



Figure 11
TOTAL TRAFFIC - YEAR 2023
Intersection Geometry

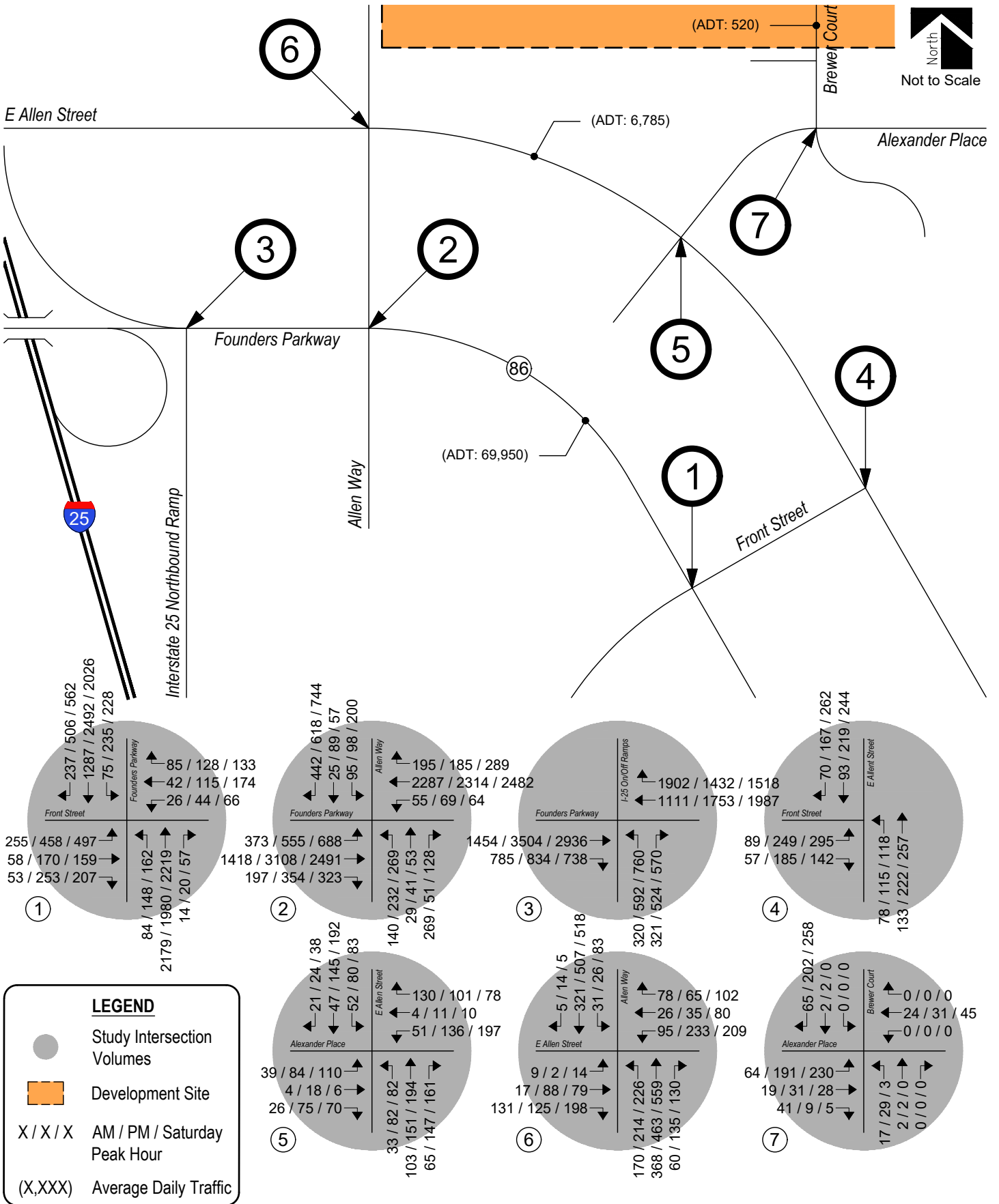
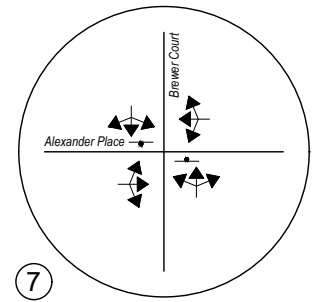
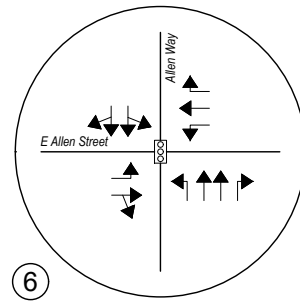
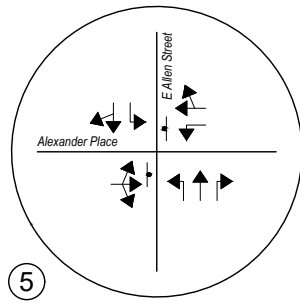
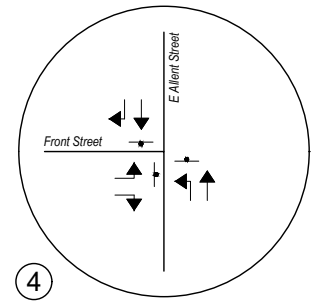
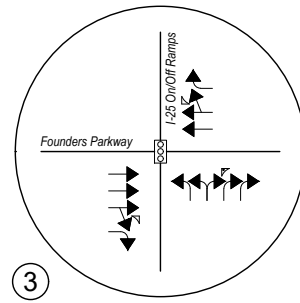
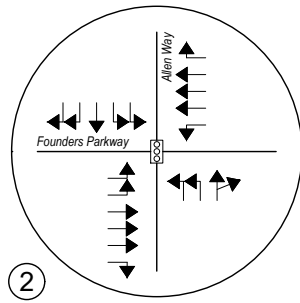
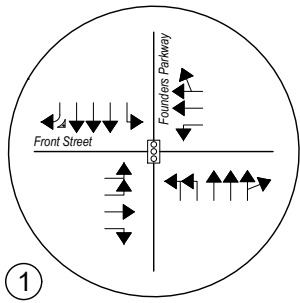
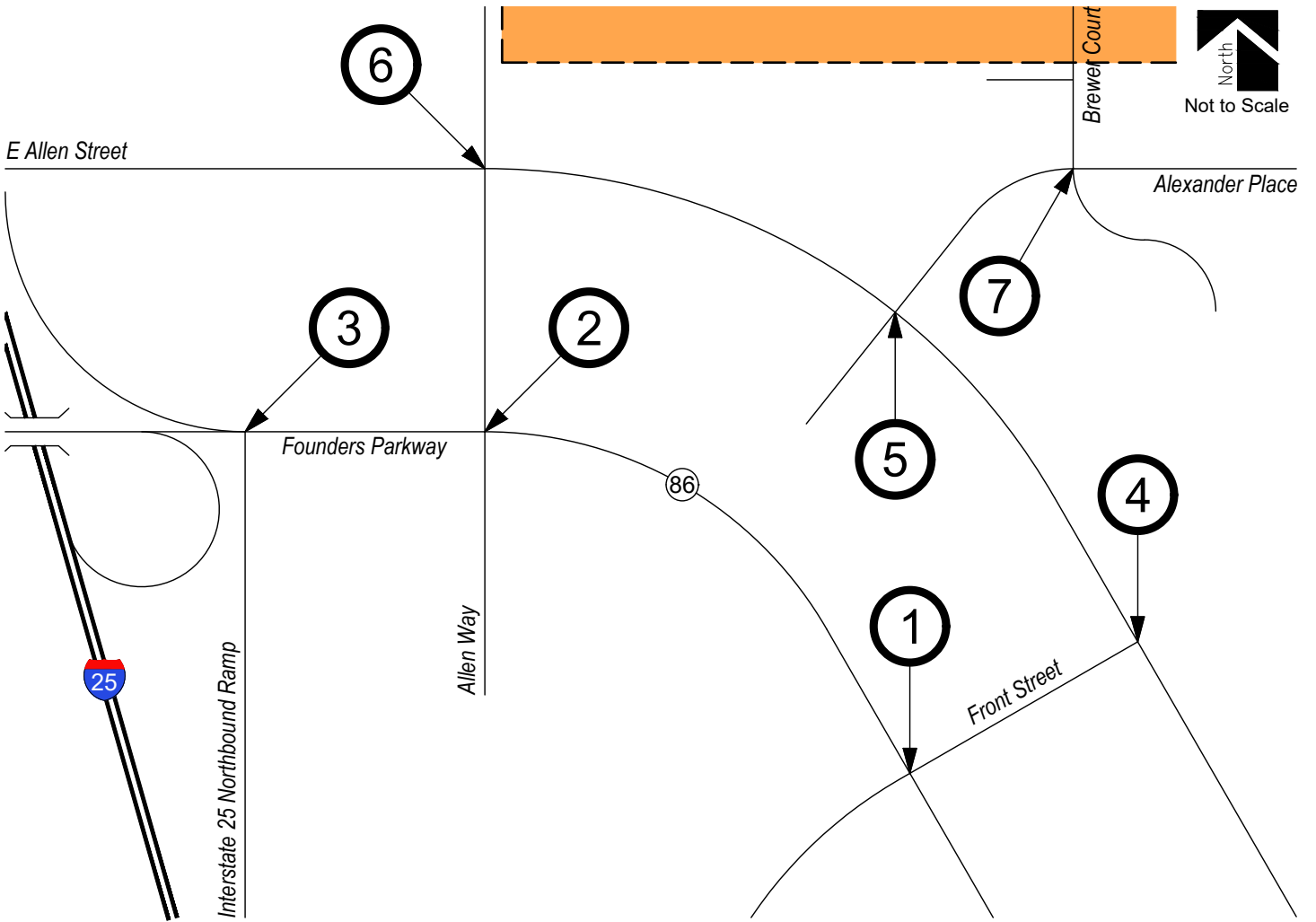

Figure 12
TOTAL TRAFFIC - YEAR 2041
 Volumes



LEGEND



-  Study Intersection Lane Geometry
-  Development Site

Figure 13
TOTAL TRAFFIC - YEAR 2041
 Intersection Geometry

VI. Project Impacts

The analyses and procedures described in this study were performed in accordance with the Highway Capacity Manual (HCM) and are based upon the worst-case conditions that occur during a typical weekday and Saturday upon build-out of site development and analyzed land uses. Therefore, study intersections are likely to operate with traffic conditions better than those described within this study, which represent the peak hours of weekday and Saturday operations only.

Peak Hour Intersection Levels of Service

As with background traffic, the operations of the study intersections were analyzed under projected total traffic conditions using the SYNCHRO computer program. Total traffic level of service analysis results for Years 2023 and 2041 are summarized in Table 6 and Table 7, respectively. At signalized intersections, the number in parentheses indicates average delay, in seconds per vehicle.

Definitions of levels of service are given in Appendix B. Intersection capacity worksheets are provided in Appendix C.

Table 6 – Intersection Capacity Analysis Summary – Total Traffic – Year 2023

INTERSECTION LANE GROUPS	LEVEL OF SERVICE		
	AM PEAK HOUR	PM PEAK HOUR	SATURDAY PEAK
Founders Parkway / Front Street (Signalized)	B (13.7)	C (23.5)	C (24.3)
Eastbound Left	D (49.9)	F (85.5)	D (38.9)
Eastbound Right	A (0.7)	C (22.1)	A (6.1)
Westbound Left	D (41.4)	D (44.5)	C (29.0)
Westbound Through and Right	C (24.2)	D (38.3)	C (27.6)
Northbound Left	A (5.8)	D (49.0)	C (28.5)
Northbound Through and Right	B (11.4)	B (14.0)	C (22.3)
Southbound Left	A (7.7)	B (17.8)	D (35.4)
Southbound Through and Right	A (9.3)	B (15.2)	C (21.6)
Founders Parkway / Allen Way (Signalized)	C (24.6)	C (25.7)	C (33.1)
Eastbound Left	E (62.6)	E (79.9)	E (63.3)
Eastbound Through and Right	B (19.2)	B (13.4)	C (22.8)
Westbound Left	B (16.3)	C (33.4)	C (30.2)
Westbound Right	A (2.7)	A (2.3)	A (3.4)
Northbound Left	D (44.3)	E (76.1)	D (41.6)
Northbound Through and Right	C (25.9)	C (32.8)	C (32.7)
Southbound Left	D (44.6)	D (50.7)	D (37.7)
Southbound Right	C (26.1)	E (41.0)	B (19.2)
Founders Parkway / I-25 NB Ramps (Signalized)	A (7.3)	B (14.6)	C (28.5)
Eastbound Through and Right	A (4.0)	B (13.9)	B (13.3)
Westbound Through and Right	A (5.3)	A (6.7)	D (45.7)
Northbound Left	E (57.2)	D (52.4)	D (42.7)
Northbound Right	A (10.0)	D (52.2)	F (94.3)
E Allen Street / Allen Way (Signalized)	A (6.3)	B (13.0)	B (10.5)
Eastbound Left	B (16.0)	B (13.5)	B (14.1)
Eastbound Through and Right	A (7.3)	A (9.0)	A (7.8)
Westbound Left	C (29.5)	D (35.1)	D (37.0)
Westbound Right	A (0.7)	A (0.4)	A (0.6)
Northbound Left	A (4.2)	B (17.4)	B (10.5)
Northbound Right	A (0.0)	A (5.1)	A (0.2)
Southbound Left, Through and Right	A (5.4)	A (7.6)	A (7.8)
E Allen Street / Alexander Place (Two-Way Stop-Controlled)			
Eastbound Left, Through and Right	B	C	C
Westbound Left	B	C	C
Westbound Through and Right	A	A	B
Northbound Left	A	A	A
Southbound Left	A	A	A
E Allen Street / Front Street (All-Way Stop-Controlled)			
Eastbound Left	A	B	B
Eastbound Right	A	A	A
Northbound Left	A	B	B
Northbound Through	A	B	B
Southbound Through	A	B	B
Southbound Right	A	A	B
Alexander Place / Brewer Court (Two-Way Stop-Controlled)			
Eastbound Left, Through and Right	A	A	A
Westbound Left, Through and Right	A	A	A
Northbound Left, Through and Right	B	B	C
Southbound Left, Through and Right	A	A	A

Key: Signalized Intersection: Level of Service (Control Delay in sec/veh)
 Stop-Controlled Intersection: Level of Service

Table 7 – Intersection Capacity Analysis Summary – Total Traffic – Year 2041

INTERSECTION LANE GROUPS	LEVEL OF SERVICE		
	AM PEAK HOUR	PM PEAK HOUR	SATURDAY PEAK
Founders Parkway / Front Street (Signalized)	B (18.0)	C (32.6)	D (41.9)
Eastbound Left	D (47.6)	E (62.3)	E (66.9)
Eastbound Right	A (1.2)	C (28.7)	B (18.8)
Westbound Left	D (42.4)	D (40.8)	C (33.8)
Westbound Through and Right	D (35.2)	D (39.2)	E (70.6)
Northbound Left	A (6.1)	C (22.8)	B (14.1)
Northbound Through and Right	B (18.4)	C (31.6)	D (52.6)
Southbound Left	C (20.9)	E (62.1)	D (45.5)
Southbound Right	A (1.6)	A (4.7)	B (14.1)
Founders Parkway / Allen Way (Signalized)	D (37.6)	D (51.2)	E (62.9)
Eastbound Left	F (85.1)	E (62.7)	F (138.7)
Eastbound Right	A (1.7)	A (4.7)	A (1.3)
Westbound Left	C (22.2)	D (51.1)	B (20.0)
Westbound Right	A (5.8)	A (5.2)	A (2.0)
Northbound Left	D (38.4)	E (58.8)	E (60.4)
Northbound Through and Right	F (93.2)	D (49.2)	F (138.1)
Southbound Left	D (40.7)	D (46.4)	D (40.7)
Southbound Right	B (14.5)	D (49.0)	F (106.6)
Founders Parkway / I-25 NB Ramps (Signalized)	B (17.8)	E (65.2)	E (68.7)
Eastbound Through and Right	A (5.7)	F (85.1)	E (62.1)
Westbound Through and Right	C (25.6)	E (58.9)	F (98.1)
Northbound Left	E (60.9)	F (84.4)	F (129.9)
Northbound Right	D (42.0)	F (131.6)	F (85.6)
E Allen Street / Allen Way (Signalized)	A (6.7)	B (12.6)	B (13.7)
Eastbound Left	B (16.7)	B (13.0)	B (13.9)
Eastbound Through and Right	A (7.4)	A (8.3)	A (7.2)
Westbound Left	C (33.1)	C (33.8)	D (35.3)
Westbound Right	A (1.0)	A (0.3)	A (0.6)
Northbound Left	A (4.8)	C (24.1)	C (30.3)
Northbound Right	A (0.0)	A (0.6)	A (9.8)
Southbound Left, Through and Right	A (5.3)	B (10.5)	B (11.2)
E Allen Street / Alexander Place (Two-Way Stop-Controlled)			
Eastbound Left, Through and Right	B	D	E
Westbound Left	B	E	F
Westbound Through and Right	A	B	B
Northbound Left	A	A	A
Southbound Left	A	A	A
E Allen Street / Front Street (All-Way Stop-Controlled)			
Eastbound Left	A	C	C
Eastbound Right	A	B	B
Northbound Left	A	B	B
Northbound Through	A	B	C
Southbound Through	A	B	C
Southbound Right	A	B	B
Alexander Place / Brewer Court (Two-Way Stop-Controlled)			
Eastbound Left, Through and Right	A	A	A
Westbound Left, Through and Right	A	A	A
Northbound Left, Through and Right	B	C	C
Southbound Left, Through and Right	A	A	A

Key: Signalized Intersection: Level of Service (Control Delay in sec/veh)
 Stop-Controlled Intersection: Level of Service

Total Traffic Analysis Results Upon Development Build-Out

Table 7 illustrates how, by Year 2041 and upon development build-out, the signalized intersection of Founders Parkway with Front Street anticipates overall operations at LOS B during the morning peak traffic hour, LOS C during the afternoon peak traffic hour, and LOS D during the Saturday peak traffic hour. In order to achieve these LOS results, signal timing was slightly adjusted by taking away 0.5 seconds of green time from the east-west movements along Founders Parkway and adding it to the north-south movements along Front Street.

The signalized intersection of Founders Parkway with Allen Way projects overall operations at LOS D during the morning and afternoon peak traffic hours, and LOS E during the Saturday peak traffic hour. The LOS E operation anticipated during the Saturday peak traffic period continues to be attributed to approach volumes from all directions.

The signalized intersection of Founders Parkway with Interstate 25 northbound on/off ramps experiences intersection operations at LOS B during the morning peak traffic hour and LOS E during the afternoon and Saturday peak traffic hours. The LOS E operations anticipated during the afternoon and Saturday peak traffic periods are attributed to approach volumes from all directions.

The signalized intersection with E Allen Street with Allen Way predicts overall operations at LOS A during the morning peak traffic hour and LOS B during the afternoon and Saturday peak traffic hours.

The stop-controlled intersection of E Allen Street with Alexander Place expects turn movement operations at or better than LOS B during the morning and Saturday peak traffic hours and LOS D or better during the afternoon peak traffic hour. Exceptions still include the eastbound shared movement and westbound left turn movement which operate at LOS E and LOS F, respectively, during the afternoon and Saturday peak traffic hours. The LOS E and LOS F operations are attributed to the through traffic volume along E Allen Street and the stop-controlled nature of the intersection.

The stop-controlled intersection of E Allen Street with Front Street projects turning movement operations at LOS A during the morning peak traffic hour and LOS C or better during the afternoon and Saturday peak traffic hours.

The stop-controlled intersection of Alexander Place with Brewer Court anticipates turn movement operations at or better than LOS B during the morning peak traffic hour and LOS C or better during the afternoon and Saturday peak traffic hours.

It is to be noted that it is not uncommon for unsignalized movements to or from an arterial roadway, in urban areas, to operate with noticeable delays during peak traffic hours. It is, however, likely that turn movements will operate better than the results obtained with this HCM Two-Way Stop-Control (TWSC) level of service analysis would indicate, as the HCM analysis may not accurately account for the effect of vehicle platooning and gaps caused by upstream signals. Upstream signal controls along E Allen Street may create additional gaps in the traffic stream for turning movements at Alexander Place and will most likely provide mitigation to the LOS E and F operations projected during peak traffic hours.

Compared to the background traffic analysis, the traffic generated by the proposed development is not expected to significantly change the operations of the study intersections.

Queue Length Analysis – Founders Parkway & Allen Way

Queue lengths for the Founders Parkway and Allen Way intersection were analyzed using Year 2041 total traffic conditions. The analysis yields estimate of 95th percentile queue lengths, which have only a five percent probability of being exceeded during the analysis time period. Queue lengths were modeled and are included with the Synchro worksheets in Appendix C.

In review of the capacity worksheets against estimated storage lengths at the intersection, significant vehicle queuing at the Founders Parkway and Allen Way intersection was indicated for various turning movements during all analyzed scenarios. During the morning peak traffic period, the northbound through and right turning movement is shown to exceed the existing storage capacity. During the afternoon peak traffic period, the northbound left and southbound right turning movements are projected to exceed existing storage capacities. During the Saturday peak traffic period, the northbound shared through and right turn movement and the southbound right turning movement are shown to exceed capacity. However, compared to Year 2041 background traffic conditions, the traffic generated by the proposed development is not shown to significantly impact vehicle queuing projections for the study intersections.

When updating the cycle length at the Founders Parkway and Allen Way intersection from 120 seconds to 100 seconds (consistent with the Founders Parkway intersection of Front Street and I-25 on/off ramps), turn lane storage lengths are expected to be able to accommodate 95th percentile queues within blocking adjacent intersections or negatively impacting operations of Founders Parkway.

VII. Additional Analysis

Per Town review comments, all-way stop-control and roundabout-control was investigated for the intersection of E Allen Street and Alexander Place.

Peak Hour Intersection Levels of Service

As with previous analysis performed, the operations of the study intersections were analyzed under projected total traffic conditions using the SYNCHRO computer program. Total traffic level of service analysis results for the E Allen Street and Alexander Place intersection, with applied all-way stop-control and roundabout-control conditions for Year 2041, are summarized in Table 8.

Definitions of levels of service are given in Appendix C. Intersection capacity worksheets for this additional analysis are provided in Appendix D.

**Table 8 – Additional Intersection Capacity Analysis Summary – Total Traffic – Year 2041
E Allen Street and Alexander Place**

INTERSECTION LANE GROUPS	LEVEL OF SERVICE		
	AM PEAK HOUR	PM PEAK HOUR	SATURDAY PEAK
E Allen Street / Alexander Place (All-Way Stop-Controlled)			
Eastbound Left, Through and Right	A	C	C
Westbound Left	A	B	C
Westbound Through and Right	A	B	B
Northbound Left	A	B	B
Northbound Through	A	B	C
Northbound Right	A	B	B
Southbound Left	A	B	B
Southbound Through and Right	A	B	C
E Allen Street / Alexander Place (Roundabout)			
Eastbound Left, Through and Right	A	A	A
Westbound Left, Through and Right	A	A	A
Northbound Left, Through and Right	A	A	A
Southbound Left, Through and Right	A	A	A

Key: Stop-Controlled Intersection: Level of Service
Roundabout Intersection: Level of Service

Total Traffic Analysis Results Upon Development Build-Out – Additional Analysis

Table 8 illustrates how, by Year 2041, upon development build-out, and with consideration of all-way stop-controlled conditions, the intersection of E Allen Street and Alexander Place projects turning movement operations at or better than LOS C during either peak traffic hour.

Under roundabout-controlled conditions, the E Allen Street and Alexander Place intersection anticipates turning movement operations at LOS A during the morning, afternoon, and Saturday peak traffic hours.

Results shown in Table 8 indicate that the implementation of all-way stop-control or a roundabout at the intersection of E Allen Street with Alexander Place is expected to provide long-term intersection operations with acceptable levels of service. Therefore, in order to consider the potential benefits of one alternative over the other, additional factors should be discussed.

It is to be noted that construction of a roundabout at the E Allen Street with Alexander Place intersection would include greater impacts to the traveling public when compared to the simple installation of additional stop signs and associated pavement markings that are required for an all-way stop-control condition. The existing intersection would need to be removed in its entirety in order to install a roundabout. Roundabout construction activities may also involve costly roadway detours as well as other additional, required traffic control activities in order to maintain safe travel for the public during demolition and reconstruction of the intersection and roadway approaches. In contrast, the implementation of all-way stop-control can often times be completed outside of the traveled way or be completed with brief traffic lane closures during non-peak traffic periods. Reconstruction of the intersection has potential to greatly disrupt existing traffic traveling to and from the home improvement store in the area as well as the surrounding businesses and residences served by E Allen Street.

An additional item for consideration is that in order to accommodate a roundabout at this location, a larger, inscribed circle diameter may be required in order to accommodate the required design vehicle resulting in the loss of acreage on all four corners of the E Allen Street and Alexander Place intersection. Appropriate inclusion of new pedestrian crosswalks would be necessary and include relocation of existing sidewalks that may require additional right-of-way. Collectively, these site constraints could be expected to result in a project that includes more impacts when compared to the all-way stop-control condition.

Based on the above considerations, site-specific factors, construction impacts to the traveling public, and existing businesses, the installation of a roundabout at the intersection of E Allen Street with Alexander Place is not recommended as a traffic mitigation solution.

VIII. Conclusion

This traffic impact study addressed the capacity, geometric, and control requirements associated with the development entitled Alexander Way Residential. This proposed residential development consists of single-family and duplex residential land uses. The development is located near the northeast corner of Alexander Place and Brewer Court in Castle Rock, Colorado.

The study area examined in this analysis encompassed the E Allen Street intersections with Alexander Place, Allen Way, and Front Street, the Founders Parkway intersections with Allen Way, Front Street, and Interstate 25 northbound on/off ramps, and the Alexander Place with Brewer Court intersection.

Analysis was conducted for critical AM Peak Hour and PM Peak Hour traffic operations for existing traffic conditions, Year 2023 and Year 2041 background traffic conditions, and Year 2023 and Year 2041 total traffic conditions.

Analysis of existing traffic conditions indicates that all signalized intersections within the study area operate at or better than LOS C during the morning, afternoon, and Saturday peak traffic hours. Similarly, all stop-controlled intersections within the study area show turn movement operations at or better than LOS C during the morning, afternoon, and Saturday peak traffic hours.

Without the proposed development, Year 2023 background operational analysis shows that all signalized intersections within the study area operate at or better than LOS C during the morning, afternoon, and Saturday peak traffic hours. Similarly, all stop-controlled intersections within the study area continue to show turn movement operations at or better than LOS C during the morning, afternoon, and Saturday peak traffic hours.

By Year 2041 and without the proposed development, operational analysis shows that all signalized intersections within the study area operate at or better than LOS D during the morning, afternoon, and Saturday peak traffic hours. Exceptions include the Founders Parkway intersections with Allen Way and Interstate 25 northbound on/off ramps, which operate at LOS E during their respective peak traffic hour. The LOS E operations anticipated during the afternoon and Saturday peak traffic periods are attributed to approach volumes from all directions. All stop-controlled intersections within the study area anticipate turn movement operations at or better than LOS C during the morning, afternoon, and Saturday peak traffic hours. Exceptions would include the eastbound shared movement and westbound left turn movement at E Allen Street and Alexander Place, which operate at LOS E and LOS F, respectively, during the Saturday peak traffic hour. The LOS E and LOS F operations are attributed to the through traffic volume along E Allen Street and the stop-controlled nature of the intersection.

It is to be noted that it is not uncommon for unsignalized movements to or from an arterial roadway, in urban areas, to operate with noticeable delays during peak traffic hours. It is, however, likely that turn movements will operate better than the results obtained with this HCM Two Way Stop Control (TWSC) level of service analysis would indicate, as the HCM analysis may not accurately account for the effect of vehicle platooning and gaps caused by upstream signals. Upstream signal controls will tend to create additional gaps in the traffic stream for turning movements at Alexander Place and will most likely provide mitigation to the LOS E and F operations projected during the Saturday peak traffic hour.

Analysis of future traffic conditions indicates that the addition of site-generated traffic is expected to create minimal negative impact to traffic operations for the existing and surrounding roadway system upon roadway and intersection control improvements assumed within this analysis. With all conservative assumptions defined in this analysis, the study intersections are projected to operate at future levels of service comparable to Year 2041 background traffic conditions. When comparing level of service and vehicle queuing results for Year 2041 background conditions to Year 2041 total traffic conditions, estimated site trips from the proposed development are not expected to add any significant delay to the study intersections.

It is our professional opinion that the proposed site-generated traffic resulting from Alexander Way Residential is expected to create no negative impact to traffic operations for the surrounding roadway network. Analysis of site-generated traffic concludes that proposed development traffic volume is considered minor.

APPENDIX A

**Traffic Count Data
Signal Timing Information**

Location: 1 I25 NB RAMPS & FOUNDERS PKWY AM

Date: Thursday, July 22, 2021

Peak Hour: 07:30 AM - 08:30 AM

Peak 15-Minutes: 07:45 AM - 08:00 AM

Peak Hour - All Vehicles

Peak Hour - Pedestrians/Bicycles on Crosswalk

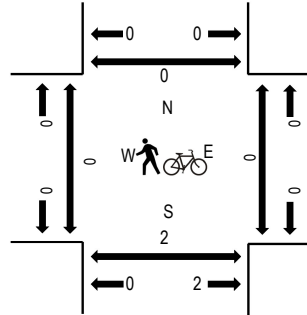
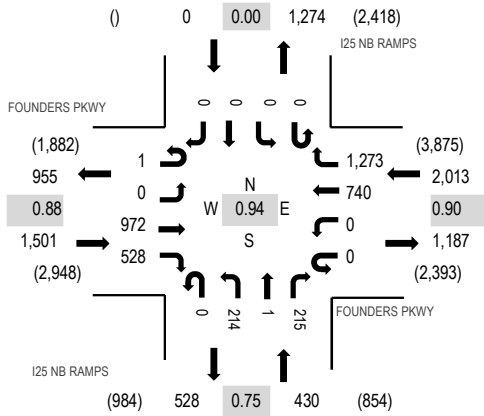

Note: Total study counts contained in parentheses.

Traffic Counts

Interval Start Time	FOUNDERS PKWY Eastbound				FOUNDERS PKWY Westbound				I25 NB RAMPS Northbound				I25 NB RAMPS Southbound				Total	Rolling Hour	Pedestrian Crossings			
	U-Turn	Left	Thru	Right	U-Turn	Left	Thru	Right	U-Turn	Left	Thru	Right	U-Turn	Left	Thru	Right			West	East	South	North
7:00 AM	0	0	177	121	0	0	154	295	0	40	0	41	0	0	0	0	828	3,753	0	0	0	0
7:15 AM	0	0	198	130	0	0	161	298	0	33	0	47	0	0	0	0	867	3,828	0	0	0	0
7:30 AM	0	0	204	145	0	0	187	371	0	62	0	44	0	0	0	0	1,013	3,944	0	0	0	0
7:45 AM	0	0	274	138	0	0	197	303	0	63	0	70	0	0	0	0	1,045	3,887	0	0	1	0
8:00 AM	0	0	224	114	0	0	184	280	0	49	1	51	0	0	0	0	903	3,924	0	0	0	0
8:15 AM	1	0	270	131	0	0	172	319	0	40	0	50	0	0	0	0	983		0	0	0	0
8:30 AM	0	0	272	104	0	0	181	287	0	51	0	61	0	0	0	0	956		0	0	0	0
8:45 AM	0	0	344	101	0	0	222	264	0	85	0	66	0	0	0	0	1,082		0	0	0	0
Count Total	1	0	1,963	984	0	0	1,458	2,417	0	423	1	430	0	0	0	0	7,677		0	0	1	0
Peak Hour	1	0	972	528	0	0	740	1,273	0	214	1	215	0	0	0	0	3,944		0	0	1	0

Location: 1 I25 NB RAMPS & FOUNDERS PKWY PM

Date: Thursday, July 22, 2021

Peak Hour: 04:30 PM - 05:30 PM

Peak 15-Minutes: 05:15 PM - 05:30 PM

Peak Hour - All Vehicles

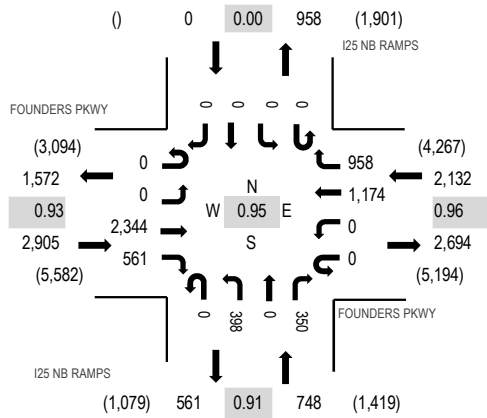

Peak Hour - Pedestrians/Bicycles on Crosswalk

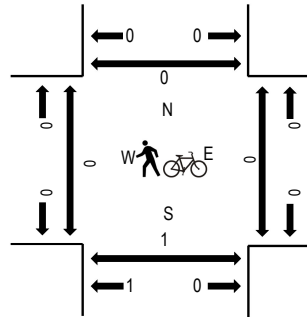

Note: Total study counts contained in parentheses.

Traffic Counts

Interval Start Time	FOUNDERS PKWY Eastbound				FOUNDERS PKWY Westbound				I25 NB RAMPS Northbound				I25 NB RAMPS Southbound				Total	Rolling Hour	Pedestrian Crossings			
	U-Turn	Left	Thru	Right	U-Turn	Left	Thru	Right	U-Turn	Left	Thru	Right	U-Turn	Left	Thru	Right			West	East	South	North
4:00 PM	0	0	518	133	0	0	295	214	0	88	0	81	0	0	0	0	1,329	5,597	0	0	0	0
4:15 PM	0	0	577	136	0	0	301	259	0	79	0	80	0	0	0	0	1,432	5,691	0	0	0	0
4:30 PM	0	0	578	145	0	0	304	246	0	97	0	73	0	0	0	0	1,443	5,785	0	0	0	0
4:45 PM	0	0	571	121	0	0	281	224	0	107	0	89	0	0	0	0	1,393	5,699	0	0	0	0
5:00 PM	0	0	559	151	0	0	296	240	0	83	0	94	0	0	0	0	1,423	5,671	0	0	1	0
5:15 PM	0	0	636	144	0	0	293	248	0	111	0	94	0	0	0	0	1,526		0	0	0	0
5:30 PM	0	0	562	130	0	0	295	226	0	60	0	84	0	0	0	0	1,357		0	0	0	0
5:45 PM	0	0	502	119	0	0	301	244	0	103	0	96	0	0	0	0	1,365		0	0	0	0
Count Total	0	0	4,503	1,079	0	0	2,366	1,901	0	728	0	691	0	0	0	0	11,268		0	0	1	0
Peak Hour	0	0	2,344	561	0	0	1,174	958	0	398	0	350	0	0	0	0	5,785		0	0	1	0



ALL TRAFFIC DATA SERVICES

(303) 216-2439

www.alltrafficdata.net

Location: 1 I25 NB RAMPS & FOUNDERS PKWY Noon

Date: Saturday, July 24, 2021

Peak Hour: 11:45 AM - 12:45 PM

Peak 15-Minutes: 12:15 PM - 12:30 PM

Peak Hour - All Vehicles

Peak Hour - Pedestrians/Bicycles on Crosswalk

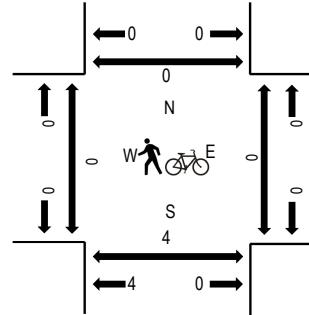
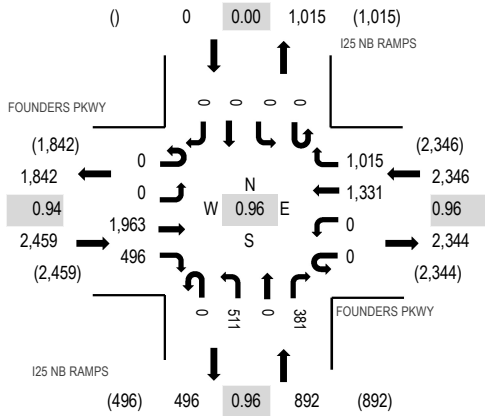

Note: Total study counts contained in parentheses.

Traffic Counts

Interval Start Time	FOUNDERS PKWY Eastbound				FOUNDERS PKWY Westbound				I25 NB RAMPS Northbound				I25 NB RAMPS Southbound				Total	Rolling Hour	Pedestrian Crossings			
	U-Turn	Left	Thru	Right	U-Turn	Left	Thru	Right	U-Turn	Left	Thru	Right	U-Turn	Left	Thru	Right			West	East	South	North
11:45 AM	0	0	444	122	0	0	349	257	0	135	0	97	0	0	0	0	1,404	5,697	0	0	0	0
12:00 PM	0	0	476	122	0	0	324	230	0	120	0	95	0	0	0	0	1,367		0	0	2	0
12:15 PM	0	0	523	129	0	0	337	277	0	119	0	96	0	0	0	0	1,481		0	0	0	0
12:30 PM	0	0	520	123	0	0	321	251	0	137	0	93	0	0	0	0	1,445		0	0	0	0
Count Total	0	0	1,963	496	0	0	1,331	1,015	0	511	0	381	0	0	0	0	5,697		0	0	2	0
Peak Hour	0	0	1,963	496	0	0	1,331	1,015	0	511	0	381	0	0	0	0	5,697		0	0	2	0

Location: 2 ALLEN WAY & FOUNDERS PKWY PM

Date: Thursday, July 22, 2021

Peak Hour: 04:30 PM - 05:30 PM

Peak 15-Minutes: 05:15 PM - 05:30 PM

Peak Hour - All Vehicles

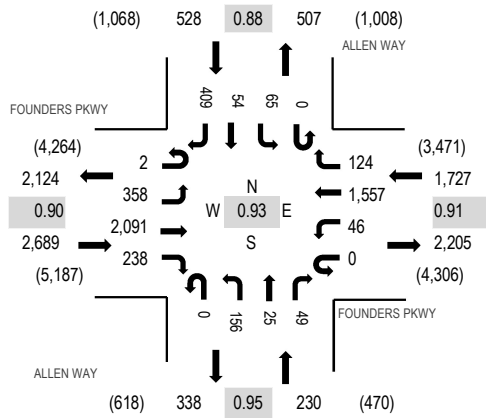

Peak Hour - Pedestrians/Bicycles on Crosswalk

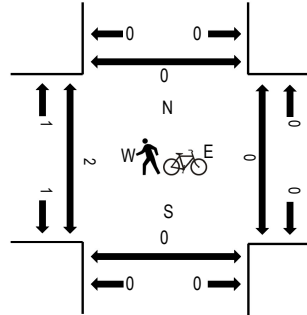

Note: Total study counts contained in parentheses.

Traffic Counts

Interval Start Time	FOUNDERS PKWY Eastbound				FOUNDERS PKWY Westbound				ALLEN WAY Northbound				ALLEN WAY Southbound				Total	Rolling Hour	Pedestrian Crossings			
	U-Turn	Left	Thru	Right	U-Turn	Left	Thru	Right	U-Turn	Left	Thru	Right	U-Turn	Left	Thru	Right			West	East	South	North
4:00 PM	0	93	474	44	0	19	364	20	0	36	7	14	0	18	11	125	1,225	5,057	1	0	0	0
4:15 PM	0	75	514	35	0	16	439	27	0	43	10	12	1	15	12	90	1,289	5,075	0	0	1	0
4:30 PM	1	92	505	57	0	15	420	22	0	37	9	17	0	15	11	107	1,308	5,174	0	0	0	0
4:45 PM	1	82	509	56	0	6	372	40	0	45	4	14	0	14	10	82	1,235	5,120	0	0	0	0
5:00 PM	0	86	498	53	0	12	355	32	0	35	8	5	0	18	15	126	1,243	5,139	1	0	0	0
5:15 PM	0	98	579	72	0	13	410	30	0	39	4	13	0	18	18	94	1,388		0	0	0	0
5:30 PM	0	99	505	44	0	19	359	35	0	36	5	9	0	24	12	107	1,254		0	0	0	0
5:45 PM	0	90	470	55	0	9	402	35	0	38	4	26	0	20	4	101	1,254		0	1	0	0
Count Total	2	715	4,054	416	0	109	3,121	241	0	309	51	110	1	142	93	832	10,196		2	1	1	0
Peak Hour	2	358	2,091	238	0	46	1,557	124	0	156	25	49	0	65	54	409	5,174		1	0	0	0

Location: 2 ALLEN WAY & FOUNDERS PKWY AM

Date: Thursday, July 22, 2021

Peak Hour: 08:00 AM - 09:00 AM

Peak 15-Minutes: 08:45 AM - 09:00 AM

Peak Hour - All Vehicles

Peak Hour - Pedestrians/Bicycles on Crosswalk

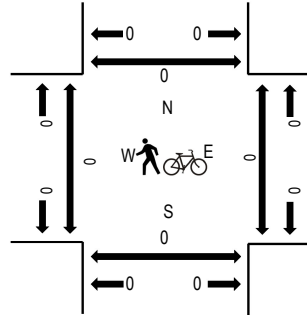
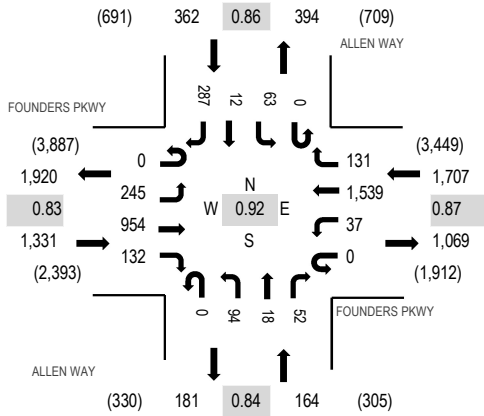

Note: Total study counts contained in parentheses.

Traffic Counts

Interval Start Time	FOUNDERS PKWY Eastbound				FOUNDERS PKWY Westbound				ALLEN WAY Northbound				ALLEN WAY Southbound				Total	Rolling Hour	Pedestrian Crossings			
	U-Turn	Left	Thru	Right	U-Turn	Left	Thru	Right	U-Turn	Left	Thru	Right	U-Turn	Left	Thru	Right			West	East	South	North
7:00 AM	0	50	148	19	0	1	375	29	0	17	3	11	0	9	2	64	728	3,274	0	0	0	0
7:15 AM	0	41	177	31	0	8	382	25	0	21	2	6	0	6	4	59	762	3,360	0	0	0	0
7:30 AM	0	45	175	28	0	7	465	38	0	29	5	10	0	11	3	65	881	3,475	0	0	0	0
7:45 AM	0	58	258	32	0	10	384	18	0	23	1	13	0	19	4	83	903	3,499	1	0	0	0
8:00 AM	0	51	191	30	0	7	397	29	0	19	8	4	0	15	1	62	814	3,564	0	0	0	0
8:15 AM	0	63	236	28	0	10	380	24	0	17	1	17	0	13	5	83	877		0	0	0	0
8:30 AM	0	56	236	37	0	7	396	44	0	30	4	15	0	17	4	59	905		0	0	0	0
8:45 AM	0	75	291	37	0	13	366	34	0	28	5	16	0	18	2	83	968		0	0	0	0
Count Total	0	439	1,712	242	0	63	3,145	241	0	184	29	92	0	108	25	558	6,838		1	0	0	0
Peak Hour	0	245	954	132	0	37	1,539	131	0	94	18	52	0	63	12	287	3,564		0	0	0	0

Location: 2 ALLEN WAY & FOUNDERS PKWY Noon

Date: Saturday, July 24, 2021

Peak Hour: 11:45 AM - 12:45 PM

Peak 15-Minutes: 12:15 PM - 12:30 PM

Peak Hour - All Vehicles

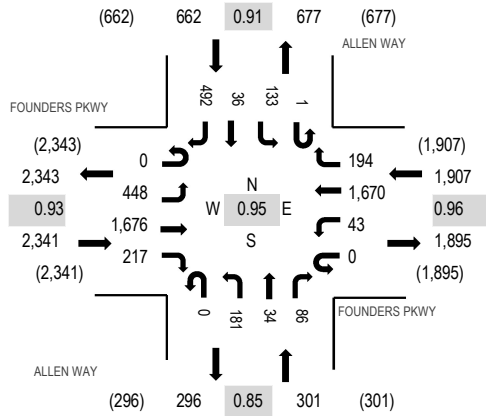

Peak Hour - Pedestrians/Bicycles on Crosswalk

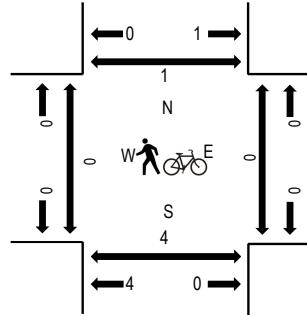

Note: Total study counts contained in parentheses.

Traffic Counts

Interval Start Time	FOUNDERS PKWY Eastbound				FOUNDERS PKWY Westbound				ALLEN WAY Northbound				ALLEN WAY Southbound				Total	Rolling Hour	Pedestrian Crossings			
	U-Turn	Left	Thru	Right	U-Turn	Left	Thru	Right	U-Turn	Left	Thru	Right	U-Turn	Left	Thru	Right			West	East	South	North
11:45 AM	0	101	397	49	0	9	431	50	0	47	17	25	0	39	9	133	1,307	5,211	0	0	0	0
12:00 PM	0	103	396	47	0	15	404	46	0	46	5	19	0	31	8	111	1,231		0	0	2	0
12:15 PM	0	117	454	56	0	10	432	57	0	37	9	25	1	34	8	128	1,368		0	0	0	0
12:30 PM	0	127	429	65	0	9	403	41	0	51	3	17	0	29	11	120	1,305		0	0	0	1
Count Total	0	448	1,676	217	0	43	1,670	194	0	181	34	86	1	133	36	492	5,211		0	0	2	1
Peak Hour	0	448	1,676	217	0	43	1,670	194	0	181	34	86	1	133	36	492	5,211		0	0	2	1



ALL TRAFFIC DATA SERVICES

(303) 216-2439

www.alltrafficdata.net

Location: 3 FRONT ST & FOUNDERS PKWY AM

Date: Thursday, July 22, 2021

Peak Hour: 08:00 AM - 09:00 AM

Peak 15-Minutes: 08:45 AM - 09:00 AM

Peak Hour - All Vehicles

Peak Hour - Pedestrians/Bicycles on Crosswalk

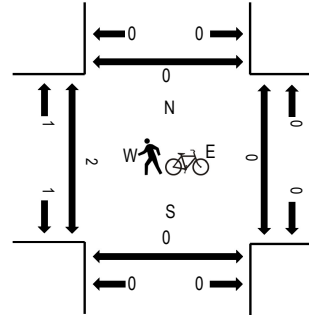
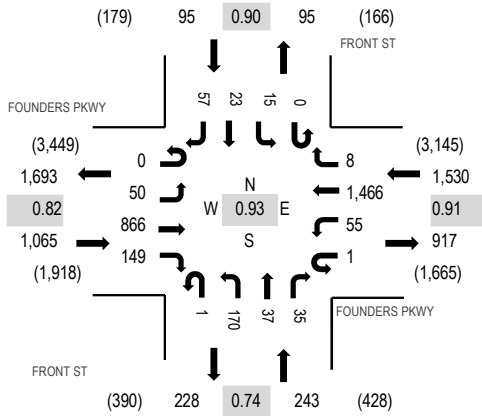

Note: Total study counts contained in parentheses.

Traffic Counts

Interval Start Time	FOUNDERS PKWY Eastbound				FOUNDERS PKWY Westbound				FRONT ST Northbound			FRONT ST Southbound				Total	Rolling Hour	Pedestrian Crossings				
	U-Turn	Left	Thru	Right	U-Turn	Left	Thru	Right	U-Turn	Left	Thru	Right	U-Turn	Left	Thru			Right	West	East	South	North
7:00 AM	1	3	145	22	0	3	342	1	0	29	5	1	0	0	4	14	570	2,737	0	0	0	0
7:15 AM	0	11	158	20	0	7	391	7	0	37	11	7	0	3	4	15	671	2,827	0	0	0	0
7:30 AM	0	12	162	23	0	13	436	0	0	45	3	6	0	1	7	8	716	2,869	0	0	0	0
7:45 AM	0	11	249	36	0	15	399	1	0	22	6	13	0	3	8	17	780	2,923	0	0	0	0
8:00 AM	0	12	168	30	0	9	360	0	0	38	9	6	0	2	7	19	660	2,933	1	0	0	0
8:15 AM	0	11	222	37	0	10	368	3	0	24	9	8	0	3	6	12	713		0	0	0	0
8:30 AM	0	7	211	43	0	18	383	2	1	59	9	13	0	5	7	12	770		1	0	0	0
8:45 AM	0	20	265	39	1	18	355	3	0	49	10	8	0	5	3	14	790		0	0	0	0
Count Total	1	87	1,580	250	1	93	3,034	17	1	303	62	62	0	22	46	111	5,670		2	0	0	0
Peak Hour	0	50	866	149	1	55	1,466	8	1	170	37	35	0	15	23	57	2,933		2	0	0	0

Location: 3 FRONT ST & FOUNDERS PKWY PM

Date: Thursday, July 22, 2021

Peak Hour: 05:00 PM - 06:00 PM

Peak 15-Minutes: 05:30 PM - 05:45 PM

Peak Hour - All Vehicles

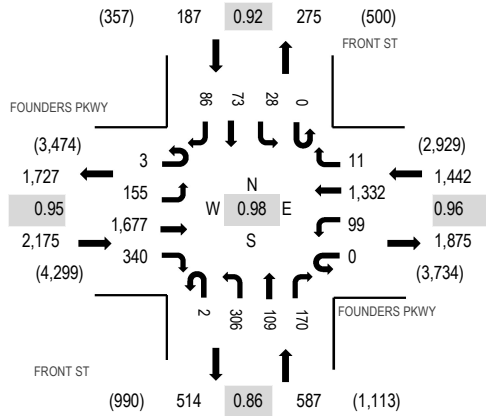

Peak Hour - Pedestrians/Bicycles on Crosswalk

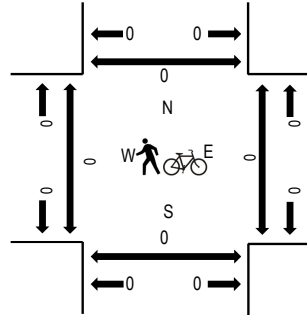

Note: Total study counts contained in parentheses.

Traffic Counts

Interval Start Time	FOUNDERS PKWY Eastbound				FOUNDERS PKWY Westbound				FRONT ST Northbound			FRONT ST Southbound				Total	Rolling Hour	Pedestrian Crossings				
	U-Turn	Left	Thru	Right	U-Turn	Left	Thru	Right	U-Turn	Left	Thru	Right	U-Turn	Left	Thru			Right	West	East	South	North
4:00 PM	2	33	399	88	0	14	334	9	0	67	19	30	0	8	17	21	1,041	4,307	0	0	0	0
4:15 PM	0	28	425	76	0	24	366	6	1	77	26	40	0	8	16	17	1,110	4,361	1	0	0	0
4:30 PM	0	25	436	90	0	25	364	3	0	74	24	50	0	6	19	10	1,126	4,352	0	0	0	0
4:45 PM	1	31	421	69	0	21	317	4	0	75	17	26	0	10	16	22	1,030	4,343	0	0	0	0
5:00 PM	3	34	422	87	0	23	362	1	1	68	19	36	0	5	16	18	1,095	4,391	0	0	0	0
5:15 PM	0	47	450	78	0	24	296	2	0	80	32	41	0	7	23	21	1,101		0	0	0	0
5:30 PM	0	36	419	96	0	25	348	3	0	73	23	44	0	8	17	25	1,117		0	0	0	0
5:45 PM	0	38	386	79	0	27	326	5	1	85	35	49	0	8	17	22	1,078		0	0	0	0
Count Total	6	272	3,358	663	0	183	2,713	33	3	599	195	316	0	60	141	156	8,698		1	0	0	0
Peak Hour	3	155	1,677	340	0	99	1,332	11	2	306	109	170	0	28	73	86	4,391		0	0	0	0

Location: 3 FRONT ST & FOUNDERS PKWY Noon

Date: Saturday, July 24, 2021

Peak Hour: 11:45 AM - 12:45 PM

Peak 15-Minutes: 12:15 PM - 12:30 PM

Peak Hour - All Vehicles

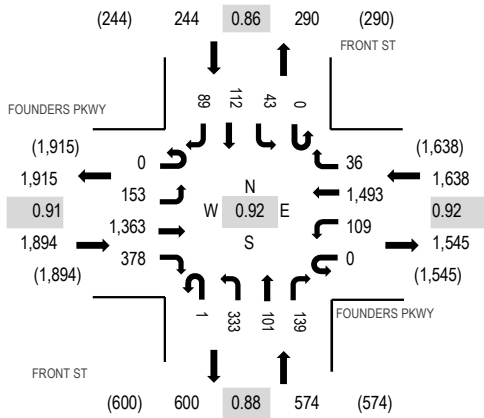

Note: Total study counts contained in parentheses.

Peak Hour - Pedestrians/Bicycles on Crosswalk

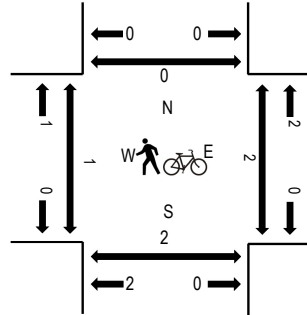

Traffic Counts

Interval Start Time	FOUNDERS PKWY Eastbound				FOUNDERS PKWY Westbound				FRONT ST Northbound			FRONT ST Southbound				Total	Rolling Hour	Pedestrian Crossings					
	U-Turn	Left	Thru	Right	U-Turn	Left	Thru	Right	U-Turn	Left	Thru	Right	U-Turn	Left	Thru			Right	West	East	South	North	
11:45 AM	0	42	330	102	0	40	385	8	8	1	86	18	41	0	9	31	15	1,108	4,350	0	0	0	0
12:00 PM	0	38	313	80	0	32	340	8	0	0	78	28	32	0	13	24	27	1,013		1	0	0	0
12:15 PM	0	34	384	103	0	22	409	13	0	0	92	34	38	0	5	25	24	1,183		0	1	0	0
12:30 PM	0	39	336	93	0	15	359	7	0	0	77	21	28	0	16	32	23	1,046		0	0	0	0
Count Total	0	153	1,363	378	0	109	1,493	36	1	1	333	101	139	0	43	112	89	4,350		1	1	0	0
Peak Hour	0	153	1,363	378	0	109	1,493	36	1	1	333	101	139	0	43	112	89	4,350		1	1	0	0

Location: 4 ALLEN WAY & ALLEN ST AM

Date: Thursday, July 22, 2021

Peak Hour: 08:00 AM - 09:00 AM

Peak 15-Minutes: 08:45 AM - 09:00 AM

Peak Hour - All Vehicles

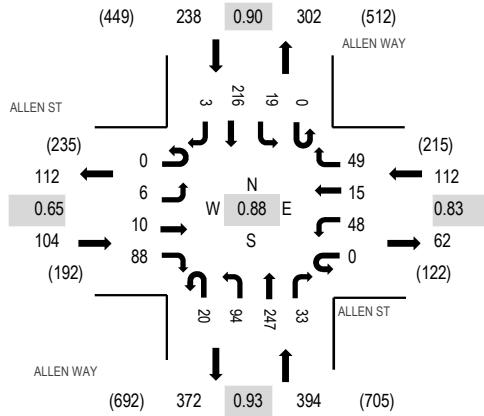

Peak Hour - Pedestrians/Bicycles on Crosswalk

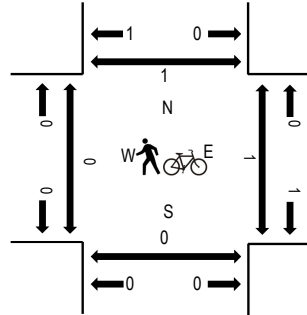

Note: Total study counts contained in parentheses.

Traffic Counts

Interval Start Time	ALLEN ST Eastbound				ALLEN ST Westbound				ALLEN WAY Northbound				ALLEN WAY Southbound				Total	Rolling Hour	Pedestrian Crossings			
	U-Turn	Left	Thru	Right	U-Turn	Left	Thru	Right	U-Turn	Left	Thru	Right	U-Turn	Left	Thru	Right			West	East	South	North
7:00 AM	0	1	1	16	0	9	3	7	1	24	41	6	0	1	49	3	162	713	0	0	0	0
7:15 AM	0	0	1	17	0	6	7	11	4	14	40	12	0	2	47	2	163	741	0	0	0	0
7:30 AM	0	2	1	23	0	12	9	13	3	27	42	15	0	1	37	2	187	789	0	0	0	0
7:45 AM	0	1	6	19	0	10	8	8	1	24	44	13	0	1	66	0	201	808	1	0	0	0
8:00 AM	0	0	1	16	0	10	5	6	6	16	65	11	0	5	49	0	190	848	0	0	0	0
8:15 AM	0	0	2	21	0	16	3	16	4	22	58	7	0	5	57	0	211		0	0	0	0
8:30 AM	0	1	1	22	0	13	1	11	7	24	59	9	0	3	55	0	206		0	1	0	0
8:45 AM	0	5	6	29	0	9	6	16	3	32	65	6	0	6	55	3	241		0	0	0	0
Count Total	0	10	19	163	0	85	42	88	29	183	414	79	0	24	415	10	1,561		1	1	0	0
Peak Hour	0	6	10	88	0	48	15	49	20	94	247	33	0	19	216	3	848		0	1	0	0

Location: 4 ALLEN WAY & ALLEN ST PM

Date: Thursday, July 22, 2021

Peak Hour: 05:00 PM - 06:00 PM

Peak 15-Minutes: 05:30 PM - 05:45 PM

Peak Hour - All Vehicles

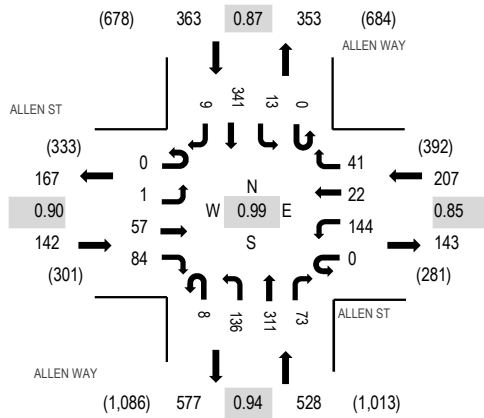

Note: Total study counts contained in parentheses.

Peak Hour - Pedestrians/Bicycles on Crosswalk

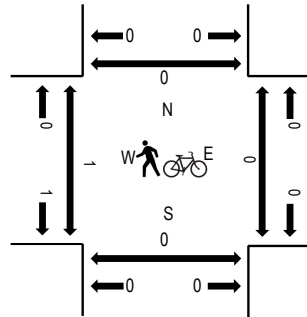

Traffic Counts

Interval Start Time	ALLEN ST Eastbound				ALLEN ST Westbound				ALLEN WAY Northbound				ALLEN WAY Southbound				Total	Rolling Hour	Pedestrian Crossings			
	U-Turn	Left	Thru	Right	U-Turn	Left	Thru	Right	U-Turn	Left	Thru	Right	U-Turn	Left	Thru	Right			West	East	South	North
4:00 PM	0	3	15	26	0	43	9	9	4	32	74	12	0	10	87	0	324	1,144	0	0	1	0
4:15 PM	0	3	13	18	0	28	6	11	4	25	75	11	0	3	70	2	269	1,132	0	0	1	0
4:30 PM	0	0	21	17	0	20	6	9	3	41	68	13	0	2	85	1	286	1,175	0	0	0	0
4:45 PM	0	0	21	22	0	28	7	9	0	37	70	16	0	1	54	0	265	1,203	0	0	0	0
5:00 PM	0	0	13	24	0	37	5	5	1	31	82	10	0	3	97	4	312	1,240	1	0	0	0
5:15 PM	0	1	17	21	0	34	5	13	5	30	82	18	0	2	80	4	312		0	0	0	0
5:30 PM	0	0	10	17	0	32	4	11	2	35	77	27	0	4	94	1	314		0	0	0	0
5:45 PM	0	0	17	22	0	41	8	12	0	40	70	18	0	4	70	0	302		0	0	0	0
Count Total	0	7	127	167	0	263	50	79	19	271	598	125	0	29	637	12	2,384		1	0	2	0
Peak Hour	0	1	57	84	0	144	22	41	8	136	311	73	0	13	341	9	1,240		1	0	0	0



ALL TRAFFIC DATA SERVICES

(303) 216-2439

www.alltrafficdata.net

Location: 4 ALLEN WAY & ALLEN ST Noon

Date: Saturday, July 24, 2021

Peak Hour: 11:45 AM - 12:45 PM

Peak 15-Minutes: 12:15 PM - 12:30 PM

Peak Hour - All Vehicles

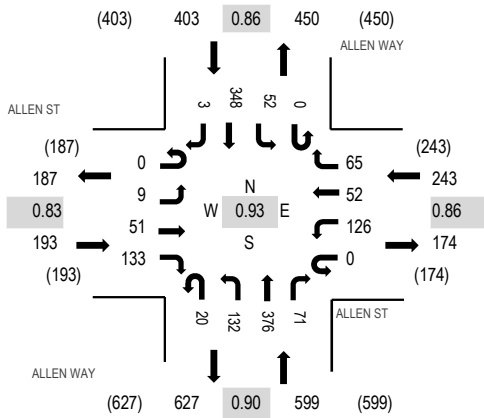

Peak Hour - Pedestrians/Bicycles on Crosswalk

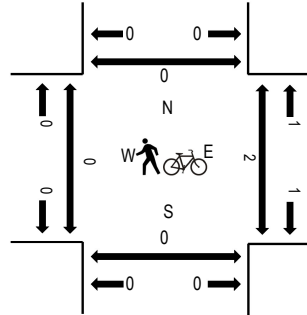

Note: Total study counts contained in parentheses.

Traffic Counts

Interval Start Time	ALLEN ST Eastbound				ALLEN ST Westbound				ALLEN WAY Northbound				ALLEN WAY Southbound				Total	Rolling Hour	Pedestrian Crossings			
	U-Turn	Left	Thru	Right	U-Turn	Left	Thru	Right	U-Turn	Left	Thru	Right	U-Turn	Left	Thru	Right			West	East	South	North
11:45 AM	0	4	10	29	0	30	9	18	4	34	84	15	0	15	102	0	354	1,438	0	0	0	0
12:00 PM	0	2	20	36	0	36	15	14	4	28	85	17	0	14	69	1	341		0	0	0	0
12:15 PM	0	2	11	37	0	35	20	16	4	32	108	23	0	11	87	0	386		0	0	0	0
12:30 PM	0	1	10	31	0	25	8	17	8	38	99	16	0	12	90	2	357		0	2	0	0
Count Total	0	9	51	133	0	126	52	65	20	132	376	71	0	52	348	3	1,438		0	2	0	0
Peak Hour	0	9	51	133	0	126	52	65	20	132	376	71	0	52	348	3	1,438		0	2	0	0

Peak Hour - All Vehicles

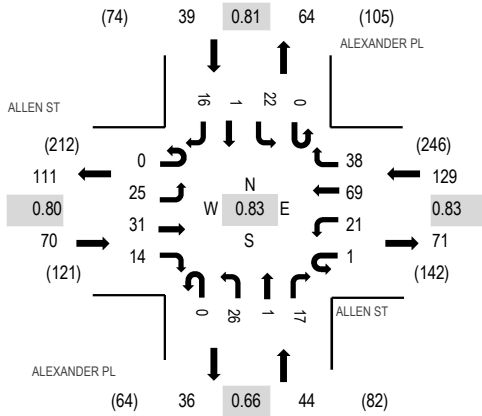

Peak Hour - Pedestrians/Bicycles on Crosswalk

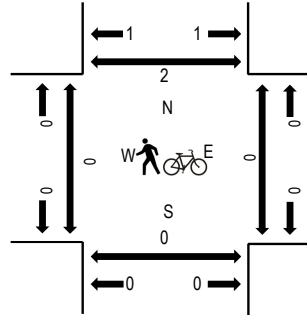

Note: Total study counts contained in parentheses.

Traffic Counts

Interval Start Time	ALLEN ST Eastbound				ALLEN ST Westbound				ALEXANDER PL Northbound				ALEXANDER PL Southbound				Total	Rolling Hour	Pedestrian Crossings			
	U-Turn	Left	Thru	Right	U-Turn	Left	Thru	Right	U-Turn	Left	Thru	Right	U-Turn	Left	Thru	Right			West	East	South	North
7:00 AM	0	4	0	1	0	0	13	4	0	5	0	4	0	5	0	1	37	241	0	0	0	0
7:15 AM	0	7	7	3	0	3	23	7	0	4	0	3	0	7	1	0	65	262	0	0	0	1
7:30 AM	0	9	3	4	0	1	23	10	0	3	0	3	0	4	0	6	66	282	0	0	0	0
7:45 AM	0	8	9	5	0	3	14	12	0	7	0	3	0	8	0	4	73	277	0	0	0	1
8:00 AM	0	5	8	2	0	6	13	9	0	5	0	4	0	3	1	2	58	282	0	0	0	1
8:15 AM	0	3	11	3	1	11	19	7	0	11	1	7	0	7	0	4	85		0	0	0	0
8:30 AM	1	4	6	1	0	9	15	3	0	4	0	8	0	7	1	2	61		0	0	0	0
8:45 AM	0	1	13	3	0	5	24	11	0	6	0	4	0	7	1	3	78		0	0	0	0
Count Total	1	41	57	22	1	38	144	63	0	45	1	36	0	48	4	22	523		0	0	0	3
Peak Hour	0	25	31	14	1	21	69	38	0	26	1	17	0	22	1	16	282		0	0	0	2

Location: 5 ALEXANDER PL & ALLEN ST PM

Date: Thursday, July 22, 2021

Peak Hour: 05:00 PM - 06:00 PM

Peak 15-Minutes: 05:45 PM - 06:00 PM

Peak Hour - All Vehicles

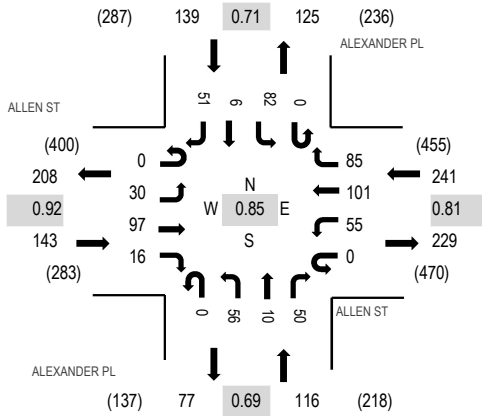

Peak Hour - Pedestrians/Bicycles on Crosswalk

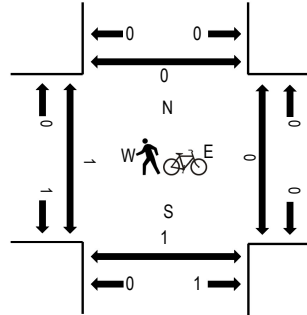

Note: Total study counts contained in parentheses.

Traffic Counts

Interval Start Time	ALLEN ST Eastbound				ALLEN ST Westbound				ALEXANDER PL Northbound				ALEXANDER PL Southbound				Total	Rolling Hour	Pedestrian Crossings			
	U-Turn	Left	Thru	Right	U-Turn	Left	Thru	Right	U-Turn	Left	Thru	Right	U-Turn	Left	Thru	Right			West	East	South	North
4:00 PM	0	4	34	1	0	12	28	22	0	14	0	10	0	34	0	18	177	604	1	0	0	1
4:15 PM	0	8	18	3	0	6	21	22	0	12	0	9	0	19	0	11	129	568	0	0	0	0
4:30 PM	0	7	24	6	0	11	16	14	0	10	2	11	0	26	3	7	137	594	1	0	2	0
4:45 PM	0	14	20	1	0	15	29	18	0	16	0	18	0	18	2	10	161	611	0	0	0	0
5:00 PM	0	7	23	2	0	9	15	20	0	13	1	13	0	18	1	19	141	639	0	0	0	0
5:15 PM	0	7	28	4	0	13	28	20	0	10	4	10	0	18	1	12	155		0	0	0	0
5:30 PM	0	7	24	5	0	13	29	20	0	9	1	13	0	22	0	11	154		0	0	0	0
5:45 PM	0	9	22	5	0	20	29	25	0	24	4	14	0	24	4	9	189		1	0	1	0
Count Total	0	63	193	27	0	99	195	161	0	108	12	98	0	179	11	97	1,243		3	0	3	1
Peak Hour	0	30	97	16	0	55	101	85	0	56	10	50	0	82	6	51	639		1	0	1	0

Location: 5 ALEXANDER PL & ALLEN ST Noon

Date: Saturday, July 24, 2021

Peak Hour: 11:45 AM - 12:45 PM

Peak 15-Minutes: 12:15 PM - 12:30 PM

Peak Hour - All Vehicles

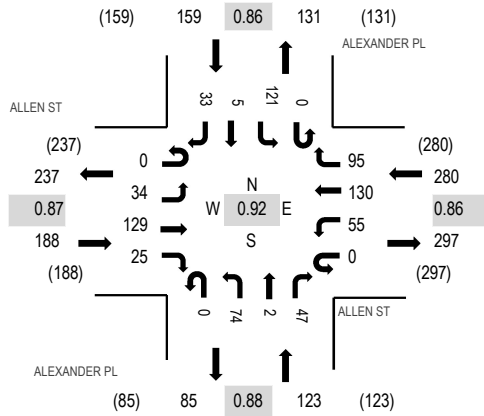

Peak Hour - Pedestrians/Bicycles on Crosswalk

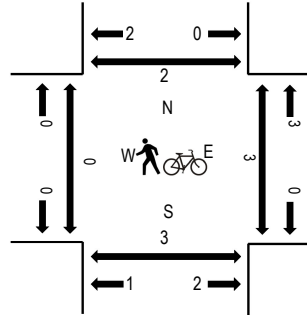

Note: Total study counts contained in parentheses.

Traffic Counts

Interval Start Time	ALLEN ST Eastbound				ALLEN ST Westbound				ALEXANDER PL Northbound				ALEXANDER PL Southbound				Total	Rolling Hour	Pedestrian Crossings			
	U-Turn	Left	Thru	Right	U-Turn	Left	Thru	Right	U-Turn	Left	Thru	Right	U-Turn	Left	Thru	Right			West	East	South	North
11:45 AM	0	9	32	5	0	10	32	17	0	15	0	13	0	27	0	6	166	750	0	0	0	0
12:00 PM	0	8	41	5	0	15	32	25	0	20	0	9	0	27	2	10	194		0	2	0	2
12:15 PM	0	9	28	9	0	13	39	29	0	22	1	12	0	28	3	10	203		0	0	3	0
12:30 PM	0	8	28	6	0	17	27	24	0	17	1	13	0	39	0	7	187		0	1	0	0
Count Total	0	34	129	25	0	55	130	95	0	74	2	47	0	121	5	33	750		0	3	3	2
Peak Hour	0	34	129	25	0	55	130	95	0	74	2	47	0	121	5	33	750		0	3	3	2



ALL TRAFFIC DATA SERVICES

(303) 216-2439

www.alltrafficdata.net

Location: 6 FRONT ST & ALLEN ST AM

Date: Thursday, July 22, 2021

Peak Hour: 08:00 AM - 09:00 AM

Peak 15-Minutes: 08:45 AM - 09:00 AM

Peak Hour - All Vehicles

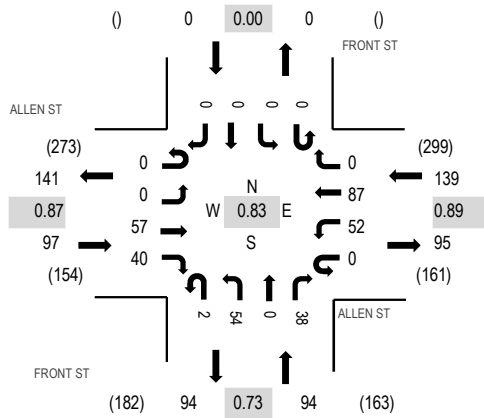

Peak Hour - Pedestrians/Bicycles on Crosswalk

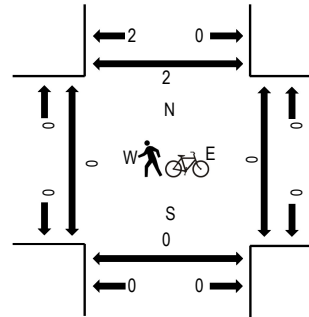

Note: Total study counts contained in parentheses.

Traffic Counts

Interval Start Time	ALLEN ST Eastbound				ALLEN ST Westbound				FRONT ST Northbound			FRONT ST Southbound				Total	Rolling Hour	Pedestrian Crossings					
	U-Turn	Left	Thru	Right	U-Turn	Left	Thru	Right	U-Turn	Left	Thru	Right	U-Turn	Left	Thru			Right	West	East	South	North	
7:00 AM	0	0	5	4	0	13	12	0	0	0	6	0	3	0	0	0	0	43	286	0	0	0	0
7:15 AM	0	0	9	7	0	15	24	0	0	0	14	0	12	0	0	0	0	81	317	0	0	0	0
7:30 AM	0	0	8	5	0	13	35	0	0	0	10	0	6	0	0	0	0	77	321	0	0	0	0
7:45 AM	0	0	15	4	0	27	21	0	0	0	10	0	8	0	0	0	0	85	315	0	0	0	0
8:00 AM	0	0	10	7	0	17	19	0	1	11	0	9	0	0	0	0	74	330	0	0	0	0	
8:15 AM	0	0	14	11	0	14	22	0	0	0	18	0	6	0	0	0	0	85		0	0	0	0
8:30 AM	0	0	14	13	0	9	18	0	0	0	8	0	9	0	0	0	0	71		0	0	0	1
8:45 AM	0	0	19	9	0	12	28	0	1	17	0	14	0	0	0	0	100		0	0	0	1	
Count Total	0	0	94	60	0	120	179	0	2	94	0	67	0	0	0	0	616		0	0	0	2	
Peak Hour	0	0	57	40	0	52	87	0	2	54	0	38	0	0	0	0	330		0	0	0	2	



ALL TRAFFIC DATA SERVICES

(303) 216-2439

www.alltrafficdata.net

Location: 6 FRONT ST & ALLEN ST PM

Date: Thursday, July 22, 2021

Peak Hour: 05:00 PM - 06:00 PM

Peak 15-Minutes: 05:45 PM - 06:00 PM

Peak Hour - All Vehicles

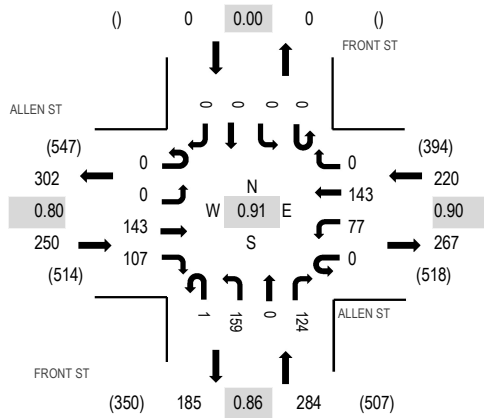

Note: Total study counts contained in parentheses.

Peak Hour - Pedestrians/Bicycles on Crosswalk

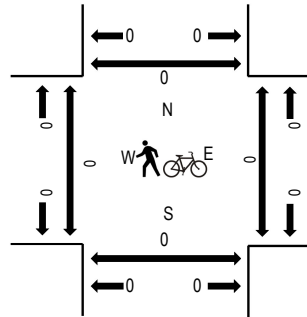

Traffic Counts

Interval Start Time	ALLEN ST Eastbound				ALLEN ST Westbound				FRONT ST Northbound				FRONT ST Southbound				Total	Rolling Hour	Pedestrian Crossings				
	U-Turn	Left	Thru	Right	U-Turn	Left	Thru	Right	U-Turn	Left	Thru	Right	U-Turn	Left	Thru	Right			West	East	South	North	
4:00 PM	0	0	48	34	0	16	30	0	0	0	41	0	21	0	0	0	0	190	661	0	0	0	0
4:15 PM	0	0	34	19	0	16	18	0	0	0	31	0	26	0	0	0	0	144	629	0	0	0	2
4:30 PM	1	0	35	26	0	10	27	0	0	0	28	0	25	0	0	0	0	152	683	0	0	0	0
4:45 PM	0	0	36	31	0	13	44	0	0	0	25	0	26	0	0	0	0	175	722	0	0	0	0
5:00 PM	0	0	30	25	0	17	26	0	0	0	28	0	32	0	0	0	0	158	754	0	0	0	0
5:15 PM	0	0	35	28	0	21	38	0	0	0	36	0	40	0	0	0	0	198		0	0	0	0
5:30 PM	0	0	36	29	0	22	39	0	0	0	35	0	30	0	0	0	0	191		0	0	0	0
5:45 PM	0	0	42	25	0	17	40	0	1	60	0	22	0	0	0	0	207		0	0	0	0	
Count Total	1	0	296	217	0	132	262	0	1	284	0	222	0	0	0	0	1,415		0	0	0	2	
Peak Hour	0	0	143	107	0	77	143	0	1	159	0	124	0	0	0	0	754		0	0	0	0	

Location: 6 FRONT ST & ALLEN ST Noon

Date: Saturday, July 24, 2021

Peak Hour: 11:45 AM - 12:45 PM

Peak 15-Minutes: 12:00 PM - 12:15 PM

Peak Hour - All Vehicles

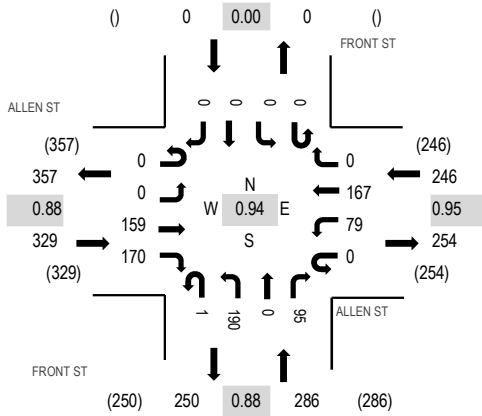

Peak Hour - Pedestrians/Bicycles on Crosswalk

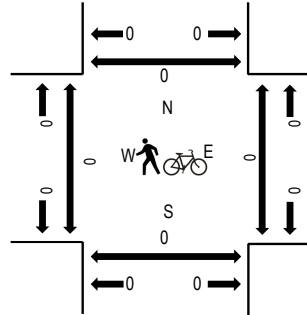

Traffic Counts

Interval Start Time	ALLEN ST Eastbound				ALLEN ST Westbound				FRONT ST Northbound			FRONT ST Southbound				Total	Rolling Hour	Pedestrian Crossings								
	U-Turn	Left	Thru	Right	U-Turn	Left	Thru	Right	U-Turn	Left	Thru	Right	U-Turn	Left	Thru			Right	West	East	South	North				
11:45 AM	0	0	39	32	0	25	40	0	0	0	38	0	19	0	0	0	0	0	0	0	193	861	0	0	0	0
12:00 PM	0	0	40	45	0	21	44	0	0	0	54	0	24	0	0	0	0	0	0	0	228		0	0	0	0
12:15 PM	0	0	41	38	0	17	48	0	0	0	50	0	31	0	0	0	0	0	0	0	225		0	0	0	0
12:30 PM	0	0	39	55	0	16	35	0	1	1	48	0	21	0	0	0	0	0	0	0	215		0	0	0	0
Count Total	0	0	159	170	0	79	167	0	1	1	190	0	95	0	0	0	0	0	0	0	861		0	0	0	0
Peak Hour	0	0	159	170	0	79	167	0	1	1	190	0	95	0	0	0	0	0	0	0	861		0	0	0	0

Location: 7 BREWER ST & ALEXANDER PL AM

Date: Thursday, July 22, 2021

Peak Hour: 07:15 AM - 08:15 AM

Peak 15-Minutes: 07:45 AM - 08:00 AM

Peak Hour - All Vehicles

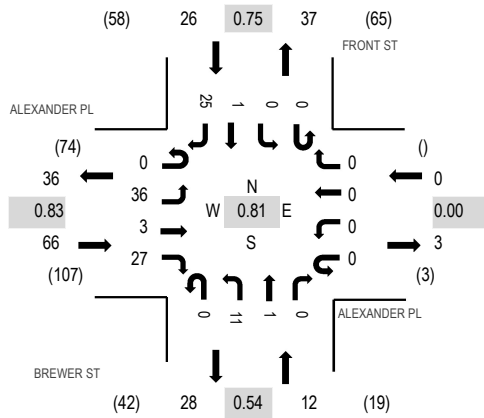

Peak Hour - Pedestrians/Bicycles on Crosswalk

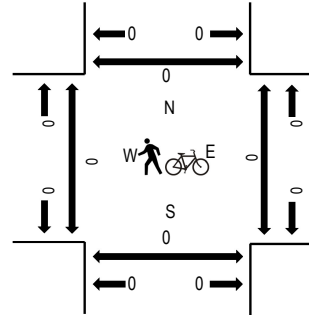

Note: Total study counts contained in parentheses.

Traffic Counts

Interval Start Time	ALEXANDER PL Eastbound				ALEXANDER PL Westbound				BREWER ST Northbound				FRONT ST Southbound				Total	Rolling Hour	Pedestrian Crossings					
	U-Turn	Left	Thru	Right	U-Turn	Left	Thru	Right	U-Turn	Left	Thru	Right	U-Turn	Left	Thru	Right			West	East	South	North		
7:00 AM	0	4	0	4	0	0	0	0	0	0	2	0	0	0	0	0	1	4	15	99	0	0	0	0
7:15 AM	0	7	0	7	0	0	0	0	0	0	0	0	0	0	0	0	8	22	104	0	0	0	0	
7:30 AM	0	11	2	6	0	0	0	0	0	0	5	1	0	0	0	0	5	30	104	0	0	0	0	
7:45 AM	0	13	0	7	0	0	0	0	0	0	5	0	0	0	0	0	7	32	94	0	0	0	0	
8:00 AM	0	5	1	7	0	0	0	0	0	0	1	0	0	0	0	1	5	20	85	0	0	0	0	
8:15 AM	1	8	0	4	0	0	0	0	0	0	1	0	0	0	0	0	8	22		0	0	0	0	
8:30 AM	0	4	0	3	0	0	0	0	0	0	2	0	0	0	0	1	10	20		0	0	0	0	
8:45 AM	1	12	0	0	0	0	0	0	0	0	2	0	0	0	0	1	7	23		0	0	0	0	
Count Total	2	64	3	38	0	0	0	0	0	0	18	1	0	0	0	4	54	184		0	0	0	0	
Peak Hour	0	36	3	27	0	0	0	0	0	0	11	1	0	0	0	1	25	104		0	0	0	0	

Location: 7 BREWER ST & ALEXANDER PL PM

Date: Thursday, July 22, 2021

Peak Hour: 04:00 PM - 05:00 PM

Peak 15-Minutes: 04:00 PM - 04:15 PM

Peak Hour - All Vehicles

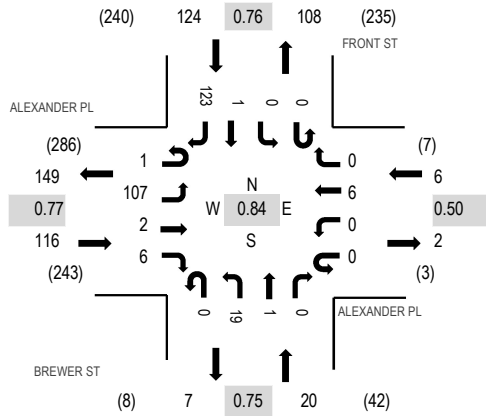

Note: Total study counts contained in parentheses.

Peak Hour - Pedestrians/Bicycles on Crosswalk

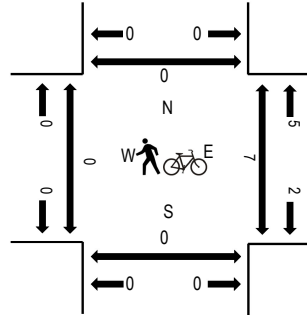

Traffic Counts

Interval Start Time	ALEXANDER PL Eastbound				ALEXANDER PL Westbound				BREWER ST Northbound			FRONT ST Southbound				Total	Rolling Hour	Pedestrian Crossings					
	U-Turn	Left	Thru	Right	U-Turn	Left	Thru	Right	U-Turn	Left	Thru	Right	U-Turn	Left	Thru			Right	West	East	South	North	
4:00 PM	1	24	1	1	0	0	3	0	0	7	1	0	0	0	0	0	41	79	266	0	3	0	0
4:15 PM	0	32	0	0	0	0	1	0	0	3	0	0	0	0	0	0	28	64	256	0	3	0	0
4:30 PM	0	22	0	1	0	0	2	0	0	4	0	0	0	0	1	0	30	60	253	0	1	0	0
4:45 PM	0	29	1	4	0	0	0	0	0	5	0	0	0	0	0	0	24	63	252	0	0	0	0
5:00 PM	0	29	0	0	0	0	1	0	0	7	0	0	0	0	1	0	31	69	266	0	0	0	0
5:15 PM	0	31	1	0	0	0	0	0	0	4	0	0	0	0	0	0	25	61		0	0	0	0
5:30 PM	0	25	0	0	0	0	0	0	0	7	1	0	0	0	0	0	26	59		0	0	0	0
5:45 PM	0	41	0	0	0	0	0	0	0	3	0	0	0	0	0	0	33	77		0	0	0	0
Count Total	1	233	3	6	0	0	7	0	0	40	2	0	0	0	2	238	532		0	7	0	0	0
Peak Hour	1	107	2	6	0	0	6	0	0	19	1	0	0	0	1	123	266		0	7	0	0	0



ALL TRAFFIC DATA SERVICES

(303) 216-2439

www.alltrafficdata.net

Location: 7 BREWER ST & ALEXANDER PL Noon

Date: Saturday, July 24, 2021

Peak Hour: 11:45 AM - 12:45 PM

Peak 15-Minutes: 12:00 PM - 12:15 PM

Peak Hour - All Vehicles

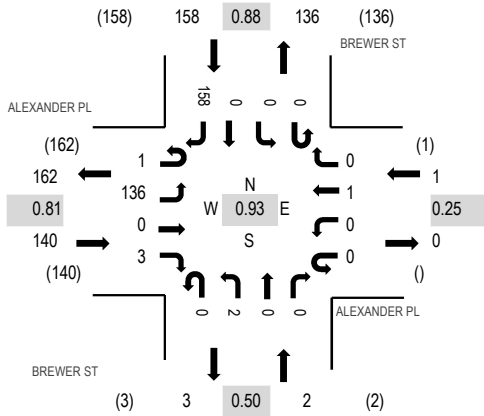

Peak Hour - Pedestrians/Bicycles on Crosswalk

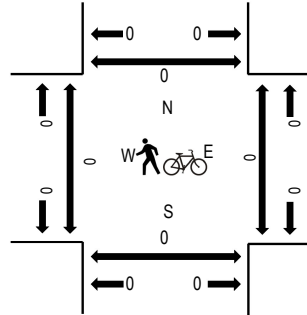

Note: Total study counts contained in parentheses.

Traffic Counts

Interval Start Time	ALEXANDER PL Eastbound				ALEXANDER PL Westbound				BREWER ST Northbound				BREWER ST Southbound				Total	Rolling Hour	Pedestrian Crossings				
	U-Turn	Left	Thru	Right	U-Turn	Left	Thru	Right	U-Turn	Left	Thru	Right	U-Turn	Left	Thru	Right			West	East	South	North	
11:45 AM	0	25	0	1	0	0	0	0	0	0	0	0	0	0	0	0	38	64	301	0	0	0	0
12:00 PM	0	41	0	2	0	0	1	0	0	1	0	0	0	0	0	0	36	81		0	0	0	0
12:15 PM	0	38	0	0	0	0	0	0	0	1	0	0	0	0	0	0	39	78		0	0	0	0
12:30 PM	1	32	0	0	0	0	0	0	0	0	0	0	0	0	0	0	45	78		0	0	0	0
Count Total	1	136	0	3	0	0	1	0	0	2	0	0	0	0	0	0	158	301		0	0	0	0
Peak Hour	1	136	0	3	0	0	1	0	0	2	0	0	0	0	0	0	158	301		0	0	0	0

Date Start: 22-Jul-21
Site Code: 8
Station ID: 8
ALLEN ST W.O. ALEXANDER PL

Start Time	22-Jul-21 Thu	EB	WB	Total
12:00 AM		1	3	4
01:00		1	1	2
02:00		0	2	2
03:00		0	3	3
04:00		3	6	9
05:00		8	23	31
06:00		32	38	70
07:00		60	103	163
08:00		61	109	170
09:00		96	132	228
10:00		129	161	290
11:00		153	207	360
12:00 PM		171	251	422
01:00		142	208	350
02:00		147	214	361
03:00		121	207	328
04:00		140	192	332
05:00		143	208	351
06:00		133	159	292
07:00		99	141	240
08:00		57	101	158
09:00		27	56	83
10:00		11	18	29
11:00		4	2	6
Total		1739	2545	4284
Percent		40.6%	59.4%	
AM Peak Vol.	-	11:00 153	11:00 207	11:00 360
PM Peak Vol.	-	12:00 171	12:00 251	12:00 422
Grand Total Percent		1739 40.6%	2545 59.4%	4284
ADT		ADT 4,284	ADT 4,284	AADT 4,284

All Traffic Data Services
www.alltrafficdata.net

Date Start: 24-Jul-21
Site Code: 8
Station ID: 8
ALLEN ST W.O. ALEXANDER PL

Start Time	24-Jul-21 Sat	EB	WB	Total
12:00 AM		4	2	6
01:00		2	1	3
02:00		4	2	6
03:00		0	0	0
04:00		1	5	6
05:00		6	17	23
06:00		11	29	40
07:00		45	63	108
08:00		62	104	166
09:00		91	144	235
10:00		113	156	269
11:00		157	215	372
12:00 PM		185	257	442
01:00		181	237	418
02:00		159	227	386
03:00		145	179	324
04:00		149	176	325
05:00		165	169	334
06:00		115	160	275
07:00		129	178	307
08:00		56	123	179
09:00		26	61	87
10:00		24	27	51
11:00		6	8	14
Total		1836	2540	4376
Percent		42.0%	58.0%	
AM Peak Vol.	-	11:00 157	11:00 215	11:00 372
PM Peak Vol.	-	12:00 185	12:00 257	12:00 442
Grand Total Percent		1836 42.0%	2540 58.0%	4376
ADT		ADT 4,376	ADT 4,376	AADT 4,376

All Traffic Data Services
www.alltrafficdata.net

Date Start: 22-Jul-21
Site Code: 9
Station ID: 9
FOUNDERS PKWY W.O. FRONT ST

Start Time	22-Jul-21 Thu	EB	WB	Total
12:00 AM		90	41	131
01:00		52	39	91
02:00		31	25	56
03:00		26	46	72
04:00		50	198	248
05:00		165	562	727
06:00		510	1260	1770
07:00		853	1756	2609
08:00		1065	1693	2758
09:00		1207	1488	2695
10:00		1319	1532	2851
11:00		1510	1685	3195
12:00 PM		1738	1655	3393
01:00		1630	1540	3170
02:00		1695	1587	3282
03:00		1792	1616	3408
04:00		2124	1747	3871
05:00		2175	1727	3902
06:00		1757	1280	3037
07:00		1239	909	2148
08:00		964	649	1613
09:00		685	456	1141
10:00		349	234	583
11:00		200	119	319
Total		23226	23844	47070
Percent		49.3%	50.7%	
AM Peak	-	11:00	07:00	-
Vol.	-	1510	1756	-
PM Peak	-	17:00	16:00	-
Vol.	-	2175	1747	-
Grand Total		23226	23844	47070
Percent		49.3%	50.7%	
ADT		ADT 47,070	ADT 47,070	AADT 47,070

All Traffic Data Services
www.alltrafficdata.net

Date Start: 24-Jul-21
Site Code: 9
Station ID: 9
FOUNDERS PKWY W.O. FRONT ST

Start Time	24-Jul-21 Sat	EB	WB	Total
12:00 AM		136	88	224
01:00		86	41	127
02:00		44	31	75
03:00		40	53	93
04:00		41	91	132
05:00		93	207	300
06:00		313	434	747
07:00		617	743	1360
08:00		864	1109	1973
09:00		1268	1517	2785
10:00		1434	1793	3227
11:00		1674	1913	3587
12:00 PM		1855	1897	3752
01:00		1847	1846	3693
02:00		1730	1744	3474
03:00		1635	1545	3180
04:00		1649	1535	3184
05:00		1202	1259	2461
06:00		1318	1227	2545
07:00		1180	919	2099
08:00		978	757	1735
09:00		697	593	1290
10:00		481	341	822
11:00		292	180	472
Total		21474	21863	43337
Percent		49.6%	50.4%	
AM Peak	-	11:00	11:00	-
Vol.	-	1674	1913	-
PM Peak	-	12:00	12:00	-
Vol.	-	1855	1897	-
Grand Total		21474	21863	43337
Percent		49.6%	50.4%	
ADT		ADT 43,337	ADT 43,337	AADT 43,337

Colo Dept of Trans.

MaxTime Timing Shee

2.0.14

Administration

Unit Information

Controller ID	0
Main St.	SH86
Side St.	Front St

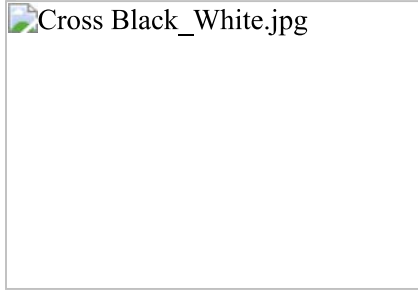

Adapter	IP Address	Subnet Mask	Default Gateway	ARP	DHCP
1	10.11.79.127	255.255.255.0	10.11.79.1	Disable	
2	10.20.70.51	255.255.255.0	0.0.0.0	Disable	

Serial Ports:

Port	Description	Function	Address	Baud	Bits	Stop	Parity	Flow	CTS	RTS
1	Port 2/C21S	None	1	9600	8	1	None	None	0	0
2	Aux_P3/C22S	None	1	9600	8	1	None	None	0	0
3	SDLC Port 1	None	1	9600	8	1	None	None	0	0
4	Com A/C50S	None	1	9600	8	1	None	None	0	0
5	FIO	None	1	9600	8	1	None	None	0	0
6	DISPLAY/C60M	None	1	9600	8	1	None	None	0	0
7	SP7	None	1	9600	8	1	None	None	0	0
8	SP8/Com B	None	1	9600	8	1	None	None	0	0

Unit Parameters

Startup Flash	0	Auto Ped Clr	Enable	Red Revert	4.0	Backup Time	600	Ext Mode	Disable
All Red Exit	6	Grn Flash Freq.	60	Yel Flash Freq.	60	MCE Enable	Enable	Free Seq.	1
MCE Seq.	1	Start Yellow	0.0	Start Red	0.0	Start Clear Hold	6		

Phase Parameters

Phases	1	2	3	4	5	6	7	8	9	10	11	12	13	14	15	16	17	18	19	20
Walk Time	0	7	0	7	0	7	0	7	0	0	0	0	0	0	0	0	0	0	0	0
Clear Time	0	33	0	28	0	24	0	27	0	0	0	0	0	0	0	0	0	0	0	0
Don't Walk	0	0	0	0	0	0	0	0	0	0	0	0	0	0	0	0	0	0	0	0
Min Green	3	20	3	5	3	20	3	5	1	1	1	1	1	1	1	1	1	1	1	1
Min Green 2	0	0	0	0	0	0	0	0	0	0	0	0	0	0	0	0	0	0	0	0
Passage	3.0	5.0	3.0	5.0	3.0	5.0	3.0	5.0	0.0	0.0	0.0	0.0	0.0	0.0	0.0	0.0	0.0	0.0	0.0	0.0
Max-1	20	75	20	35	20	75	20	35	0	0	0	0	0	0	0	0	0	0	0	0
Max-2	10	30	10	15	10	30	10	15	0	0	0	0	0	0	0	0	0	0	0	0
Max-3	0	0	0	0	0	0	0	0	0	0	0	0	0	0	0	0	0	0	0	0
Yel Change	3.0	4.0	3.0	4.0	3.0	4.0	3.0	4.0	3.0	3.0	3.0	3.0	3.0	3.0	3.0	3.0	3.0	3.0	3.0	3.0
Red Clear	2.0	2.0	2.0	2.0	2.0	2.0	2.0	2.0	0.0	0.0	0.0	0.0	0.0	0.0	0.0	0.0	0.0	0.0	0.0	0.0
Add Red Clear	0	0	0	0	0	0	0	0	0	0	0	0	0	0	0	0	0	0	0	0
Red Revert	0.0	0.0	0.0	0.0	0.0	0.0	0.0	0.0	0.0	0.0	0.0	0.0	0.0	0.0	0.0	0.0	0.0	0.0	0.0	0.0
Added Initial	0.0	0.0	0.0	0.0	0.0	0.0	0.0	0.0	0.0	0.0	0.0	0.0	0.0	0.0	0.0	0.0	0.0	0.0	0.0	0.0
Max Initial	0.0	0.0	0.0	0.0	0.0	0.0	0.0	0.0	0.0	0.0	0.0	0.0	0.0	0.0	0.0	0.0	0.0	0.0	0.0	0.0
Time B4 Reduce	0	0	0	0	0	0	0	0	0	0	0	0	0	0	0	0	0	0	0	0
Cars B4 Reduce	0	0	0	0	0	0	0	0	0	0	0	0	0	0	0	0	0	0	0	0
Time To Reduce	0	0	0	0	0	0	0	0	0	0	0	0	0	0	0	0	0	0	0	0
Reduce By	0.0	0.0	0.0	0.0	0.0	0.0	0.0	0.0	0.0	0.0	0.0	0.0	0.0	0.0	0.0	0.0	0.0	0.0	0.0	0.0
Min Gap	0.0	0.0	0.0	0.0	0.0	0.0	0.0	0.0	0.0	0.0	0.0	0.0	0.0	0.0	0.0	0.0	0.0	0.0	0.0	0.0
Dyn Max Limit	0	0	0	0	0	0	0	0	0	0	0	0	0	0	0	0	0	0	0	0
Dyn Max Step	0.0	0.0	0.0	0.0	0.0	0.0	0.0	0.0	0.0	0.0	0.0	0.0	0.0	0.0	0.0	0.0	0.0	0.0	0.0	0.0
Advance Walk	0	0	0	0	0	0	0	0	0	0	0	0	0	0	0	0	0	0	0	0
Delay Ped	0	0	0	0	0	0	0	0	0	0	0	0	0	0	0	0	0	0	0	0
Alt Walk	0	0	0	0	0	0	0	0	0	0	0	0	0	0	0	0	0	0	0	0
Alt Ped Clr																				
Pre Green	0.0	0.0	0.0	0.0	0.0	0.0	0.0	0.0	0.0	0.0	0.0	0.0	0.0	0.0	0.0	0.0	0.0	0.0	0.0	0.0
Pre Clearance	0.0	0.0	0.0	0.0	0.0	0.0	0.0	0.0	0.0	0.0	0.0	0.0	0.0	0.0	0.0	0.0	0.0	0.0	0.0	0.0

Phases	21	22	23	24	25	26	27	28	29	30	31	32	33	34	35	36	37	38	39	40
Walk Time	0	0	0	0	0	0	0	0	0	0	0	0	0	0	0	0	0	0	0	0
Clear Time	0	0	0	0	0	0	0	0	0	0	0	0	0	0	0	0	0	0	0	0
Don't Walk	0	0	0	0	0	0	0	0	0	0	0	0	0	0	0	0	0	0	0	0
Min Green	1	1	1	1	1	1	1	1	1	1	1	1	1	1	1	1	1	1	1	1

Min Green 2	0	0	0	0	0	0	0	0	0	0	0	0	0	0	0	0	0	0	0
Passage	0.0	0.0	0.0	0.0	0.0	0.0	0.0	0.0	0.0	0.0	0.0	0.0	0.0	0.0	0.0	0.0	0.0	0.0	0.0
Max-1	0	0	0	0	0	0	0	0	0	0	0	0	0	0	0	0	0	0	0
Max-2	0	0	0	0	0	0	0	0	0	0	0	0	0	0	0	0	0	0	0
Max-3	0	0	0	0	0	0	0	0	0	0	0	0	0	0	0	0	0	0	0
Yel Change	3.0	3.0	3.0	3.0	3.0	3.0	3.0	3.0	3.0	3.0	3.0	3.0	3.0	3.0	3.0	3.0	3.0	3.0	3.0
Red Clear	0.0	0.0	0.0	0.0	0.0	0.0	0.0	0.0	0.0	0.0	0.0	0.0	0.0	0.0	0.0	0.0	0.0	0.0	0.0
Add Red Clear	0	0	0	0	0	0	0	0	0	0	0	0	0	0	0	0	0	0	0
Red Revert	0.0	0.0	0.0	0.0	0.0	0.0	0.0	0.0	0.0	0.0	0.0	0.0	0.0	0.0	0.0	0.0	0.0	0.0	0.0
Added Initial	0.0	0.0	0.0	0.0	0.0	0.0	0.0	0.0	0.0	0.0	0.0	0.0	0.0	0.0	0.0	0.0	0.0	0.0	0.0
Max Initial	0.0	0.0	0.0	0.0	0.0	0.0	0.0	0.0	0.0	0.0	0.0	0.0	0.0	0.0	0.0	0.0	0.0	0.0	0.0
Time B4 Reduce	0	0	0	0	0	0	0	0	0	0	0	0	0	0	0	0	0	0	0
Cars B4 Reduce	0	0	0	0	0	0	0	0	0	0	0	0	0	0	0	0	0	0	0
Time To Reduce	0	0	0	0	0	0	0	0	0	0	0	0	0	0	0	0	0	0	0
Reduce By	0.0	0.0	0.0	0.0	0.0	0.0	0.0	0.0	0.0	0.0	0.0	0.0	0.0	0.0	0.0	0.0	0.0	0.0	0.0
Min Gap	0.0	0.0	0.0	0.0	0.0	0.0	0.0	0.0	0.0	0.0	0.0	0.0	0.0	0.0	0.0	0.0	0.0	0.0	0.0
Dyn Max Limit	0	0	0	0	0	0	0	0	0	0	0	0	0	0	0	0	0	0	0
Dyn Max Step	0.0	0.0	0.0	0.0	0.0	0.0	0.0	0.0	0.0	0.0	0.0	0.0	0.0	0.0	0.0	0.0	0.0	0.0	0.0
Advance Walk	0	0	0	0	0	0	0	0	0	0	0	0	0	0	0	0	0	0	0
Delay Ped	0	0	0	0	0	0	0	0	0	0	0	0	0	0	0	0	0	0	0
Alt Walk	0	0	0	0	0	0	0	0	0	0	0	0	0	0	0	0	0	0	0
Alt Ped Cir																			
Pre Green	0.0	0.0	0.0	0.0	0.0	0.0	0.0	0.0	0.0	0.0	0.0	0.0	0.0	0.0	0.0	0.0	0.0	0.0	0.0
Pre Clearance	0.0	0.0	0.0	0.0	0.0	0.0	0.0	0.0	0.0	0.0	0.0	0.0	0.0	0.0	0.0	0.0	0.0	0.0	0.0

Phase Options

Phases	1	2	3	4	5	6	7	8	9	10	11	12	13	14	15	16	17	18	19	20
Enable	X	X	X	X	X	X	X	X												
Auto Flash Ent.		X				X														
Auto Flash Exit		X				X														
Non Actuated I																				
Non Actuated II																				
Non Lock Mem	X	X	X	X	X	X	X	X												
Min Veh Recall		X				X														
Max Veh Recall																				
Ped Recall																				
Soft Veh Recall																				
Dual Entry																				
Sim Gap Dis																				
Guaranteed Pass																				
Act Rest Walk																				
Cond Service																				
Add Initial																				

Phases	21	22	23	24	25	26	27	28	29	30	31	32	33	34	35	36	37	38	39	40
Enable																				
Auto Flash Ent.																				
Auto Flash Exit																				
Non Actuated I																				
Non Actuated II																				
Non Lock Mem																				
Min Veh Recall																				
Max Veh Recall																				
Ped Recall																				
Soft Veh Recall																				
Dual Entry																				
Sim Gap Dis																				
Guaranteed Pass																				
Act Rest Walk																				
Cond Service																				
Add Initial																				

Additional Phase Options

--	--	--	--	--	--	--	--	--	--	--	--	--	--	--	--	--	--	--	--	--

Phases	1	2	3	4	5	6	7	8	9	10	11	12	13	14	15	16	17	18	19	20	
Ped Clr During Yel																					
Ped Clr During Red																					
Cond Reservice																					
Yel Min Override																					
No Startup Call																					
Adv. Warn Flasher																					
No Ped Str Up Call																					
Ped Clr OVTG																					
Flash Exit Call																					
Flash Exit Ped Call																					
MinGreen2																					
MaxGreen2																					
MaxGreen3																					
Ped2																					
Ped Clear Pre Clear																					
Ped NA+ Mode																					
Red Rest																					
Serve Evy Oth Even																					
Serve Evy Oth Odd																					

Phases	21	22	23	24	25	26	27	28	29	30	31	32	33	34	35	36	37	38	39	40	
Ped Clr During Yel																					
Ped Clr During Red																					
Cond Reservice																					
Yel Min Override																					
No Startup Call																					
Adv. Warn Flasher																					
No Ped Str Up Call																					
Ped Clr OVTG																					
Flash Exit Call																					
Flash Exit Ped Call																					
MinGreen2																					
MaxGreen2																					
MaxGreen3																					
Ped2																					
Ped Clear Pre Clear																					
Ped NA+ Mode																					
Red Rest																					
Serve Evy Oth Even																					
Serve Evy Oth Odd																					

Phase Configuration

Ph.	Startup	Ring	Concurrent	No Served Phases	Startup Min	Description
1	Phase Not On	1	5,6		0	
2	Green No Walk	1	5,6		0	
3	Phase Not On	1	7,8		0	
4	Phase Not On	1	7,8		0	
5	Phase Not On	2	1,2		0	
6	Green No Walk	2	1,2		0	
7	Phase Not On	2	3,4		0	
8	Phase Not On	2	3,4		0	
9	None	0			0	
10	None	0			0	
11	None	0			0	
12	None	0			0	
13	None	0			0	
14	None	0			0	
15	None	0			0	
16	None	0			0	
17	None	0			0	
18	None	0			0	
19	None	0			0	
20	None	0			0	

21	None	0			0	
22	None	0			0	
23	None	0			0	
24	None	0			0	
25	None	0			0	
26	None	0			0	
27	None	0			0	
28	None	0			0	
29	None	0			0	
30	None	0			0	
31	None	0			0	
32	None	0			0	
33	None	0			0	
34	None	0			0	
35	None	0			0	
36	None	0			0	
37	None	0			0	
38	None	0			0	
39	None	0			0	
40	None	0			0	

Sequence Configuration

Sequence 1

Ring	Phases
1	1,2,a,3,4,b
2	5,6,a,7,8,b
3	
4	
5	
6	
7	
8	
9	
10	
11	
12	
13	
14	
15	
16	

Sequence 2

Ring	Phases
1	1,2,a,3,4,b
2	5,6,a,7,8,b
3	
4	
5	
6	
7	
8	
9	
10	
11	
12	
13	
14	
15	
16	

Sequence 3

Ring	Phases
1	1,2,a,3,4,b
2	5,6,a,7,8,b
3	
4	
5	
6	
7	
8	
9	
10	
11	
12	
13	
14	
15	
16	

Sequence 4

Ring	Phases
1	1,2,a,3,4,b
2	5,6,a,7,8,b
3	
4	
5	
6	
7	
8	
9	
10	
11	
12	
13	
14	
15	
16	

Sequence 5

Ring	Phases
1	1,2,a,3,4,b
2	6,5,a,7,8,b
3	
4	
5	
6	
7	
8	
9	
10	
11	
12	
13	
14	
15	
16	

Sequence 6

Ring	Phases
1	2,1,a,3,4,b
2	6,5,a,7,8,b
3	
4	
5	
6	
7	
8	
9	
10	
11	
12	
13	
14	
15	
16	

Sequence 7

Ring	Phases
1	1,2,a,4,3,b
2	6,5,a,7,8,b
3	
4	
5	
6	
7	
8	
9	
10	
11	
12	
13	
14	
15	
16	

Sequence 8

Ring	Phases
1	2,1,a,4,3,b
2	6,5,a,7,8,b
3	
4	
5	
6	
7	
8	
9	
10	
11	
12	
13	
14	
15	
16	

Sequence 9

Ring	Phases
1	1,2,a,3,4,b

Sequence 10

Ring	Phases
1	2,1,a,3,4,b

Sequence 11

Ring	Phases
1	1,2,a,4,3,b

Sequence 12

Ring	Phases
1	2,1,a,4,3,b

2	5,6,a,8,7,b
3	
4	
5	
6	
7	
8	
9	
10	
11	
12	
13	
14	
15	
16	

2	5,6,a,8,7,b
3	
4	
5	
6	
7	
8	
9	
10	
11	
12	
13	
14	
15	
16	

2	5,6,a,8,7,b
3	
4	
5	
6	
7	
8	
9	
10	
11	
12	
13	
14	
15	
16	

2	5,6,a,8,7,b
3	
4	
5	
6	
7	
8	
9	
10	
11	
12	
13	
14	
15	
16	

Sequence 13

Ring	Phases
1	1,2,a,3,4,b
2	6,5,a,8,7,b
3	
4	
5	
6	
7	
8	
9	
10	

Sequence 14

Ring	Phases
1	2,1,a,3,4,b
2	6,5,a,8,7,b
3	
4	
5	
6	
7	
8	
9	
10	

Sequence 15

Ring	Phases
1	1,2,a,4,3,b
2	6,5,a,8,7,b
3	
4	
5	
6	
7	
8	
9	
10	

Sequence 16

Ring	Phases
1	2,1,a,4,3,b
2	6,5,a,8,7,b
3	
4	
5	
6	
7	
8	
9	
10	

Sequence 13

11	
12	
13	
14	
15	
16	

Sequence 14

11	
12	
13	
14	
15	
16	

Sequence 15

11	
12	
13	
14	
15	
16	

Sequence 16

11	
12	
13	
14	
15	
16	

Sequence 17

Ring	Phases
1	
2	
3	
4	
5	
6	
7	
8	
9	
10	
11	
12	
13	
14	
15	
16	

Sequence 18

Ring	Phases
1	
2	
3	
4	
5	
6	
7	
8	
9	
10	
11	
12	
13	
14	
15	
16	

Sequence 19

Ring	Phases
1	
2	
3	
4	
5	
6	
7	
8	
9	
10	
11	
12	
13	
14	
15	
16	

Sequence 20

Ring	Phases
1	1,2,a,3,4,b
2	5,6,a,7,8,b
3	
4	
5	
6	
7	
8	
9	
10	
11	
12	
13	
14	
15	
16	

Vehicle Detection Parameters

Det.	Call Phs	Call OVI	Additional Call Phase	Switch Phase	Delay	Extend	Queue Limit	No Activity	Max Presence	Erratic Counts	Failed Time	Description
1	1	0		0	0.0	0.0	0	0	0	0	0	
2	2	0		0	0.0	0.0	0	0	0	0	0	
3	2	0		0	0.0	0.0	0	0	0	0	0	
4	2	0		0	0.0	0.0	0	0	0	0	0	

5	2	0		0	0.0	0.0	0	0	0	0	0
6	2	0		0	0.0	0.0	0	0	0	0	0
7	3	0		0	0.0	0.0	0	0	0	0	0
8	4	0		0	0.0	0.0	0	0	0	0	0
9	4	0		0	0.0	0.0	0	0	0	0	0
10	4	0		0	0.0	0.0	0	0	0	0	0
11	4	0		0	0.0	0.0	0	0	0	0	0
12	4	0		0	0.0	0.0	0	0	0	0	0
13	1	0		0	0.0	0.0	0	0	0	0	0
14	3	0		0	0.0	0.0	0	0	0	0	0
15	5	0		0	0.0	0.0	0	0	0	0	0
16	6	0		0	0.0	0.0	0	0	0	0	0
17	6	0		0	0.0	0.0	0	0	0	0	0
18	6	0		0	0.0	0.0	0	0	0	0	0
19	6	0		0	0.0	0.0	0	0	0	0	0
20	6	0		0	0.0	0.0	0	0	0	0	0
21	7	0		0	0.0	0.0	0	0	0	0	0
22	8	0		0	0.0	0.0	0	0	0	0	0
23	8	0		0	0.0	0.0	0	0	0	0	0
24	8	0		0	0.0	0.0	0	0	0	0	0
25	8	0		0	0.0	0.0	0	0	0	0	0
26	8	0		0	0.0	0.0	0	0	0	0	0
27	5	0		0	0.0	0.0	0	0	0	0	0
28	7	0		0	0.0	0.0	0	0	0	0	0
29	0	0		0	0.0	0.0	0	0	0	0	0
30	0	0		0	0.0	0.0	0	0	0	0	0
31	0	0		0	0.0	0.0	0	0	0	0	0
32	0	0		0	0.0	0.0	0	0	0	0	0
33	0	0		0	0.0	0.0	0	0	0	0	0
34	0	0		0	0.0	0.0	0	0	0	0	0
35	0	0		0	0.0	0.0	0	0	0	0	0
36	0	0		0	0.0	0.0	0	0	0	0	0
37	0	0		0	0.0	0.0	0	0	0	0	0
38	0	0		0	0.0	0.0	0	0	0	0	0
39	0	0		0	0.0	0.0	0	0	0	0	0
40	0	0		0	0.0	0.0	0	0	0	0	0
41	0	0		0	0.0	0.0	0	0	0	0	0
42	0	0		0	0.0	0.0	0	0	0	0	0
43	0	0		0	0.0	0.0	0	0	0	0	0
44	0	0		0	0.0	0.0	0	0	0	0	0
45	0	0		0	0.0	0.0	0	0	0	0	0
46	0	0		0	0.0	0.0	0	0	0	0	0
47	0	0		0	0.0	0.0	0	0	0	0	0
48	0	0		0	0.0	0.0	0	0	0	0	0
49	0	0		0	0.0	0.0	0	0	0	0	0
50	0	0		0	0.0	0.0	0	0	0	0	0
51	0	0		0	0.0	0.0	0	0	0	0	0
52	0	0		0	0.0	0.0	0	0	0	0	0
53	0	0		0	0.0	0.0	0	0	0	0	0
54	0	0		0	0.0	0.0	0	0	0	0	0
55	0	0		0	0.0	0.0	0	0	0	0	0
56	0	0		0	0.0	0.0	0	0	0	0	0
57	0	0		0	0.0	0.0	0	0	0	0	0
58	0	0		0	0.0	0.0	0	0	0	0	0
59	0	0		0	0.0	0.0	0	0	0	0	0
60	0	0		0	0.0	0.0	0	0	0	0	0
61	0	0		0	0.0	0.0	0	0	0	0	0
62	0	0		0	0.0	0.0	0	0	0	0	0
63	0	0		0	0.0	0.0	0	0	0	0	0
64	0	0		0	0.0	0.0	0	0	0	0	0
65	0	0		0	0.0	0.0	0	0	0	0	0
66	0	0		0	0.0	0.0	0	0	0	0	0
67	0	0		0	0.0	0.0	0	0	0	0	0
68	0	0		0	0.0	0.0	0	0	0	0	0

69	0	0		0	0.0	0.0	0	0	0	0	0	
70	0	0		0	0.0	0.0	0	0	0	0	0	
71	0	0		0	0.0	0.0	0	0	0	0	0	
72	0	0		0	0.0	0.0	0	0	0	0	0	

Vehicle Detection Options

Detector	1	2	3	4	5	6	7	8	9	10	11	12	13	14	15	16	17	18	19	20	
Volume Detector	X	X	X	X	X	X	X	X	X	X	X	X	X	X	X	X	X	X	X	X	X
Occupancy	X	X	X	X	X	X	X	X	X	X	X	X	X	X	X	X	X	X	X	X	X
Yellow Lock Call																					
Red Lock call																					
Passage	X	X	X	X	X	X	X	X	X	X	X	X	X	X	X	X	X	X	X	X	X
Queue																					
Call	X	X	X	X	X	X	X	X	X	X	X	X	X	X	X	X	X	X	X	X	X
Terminate																					

Detector	21	22	23	24	25	26	27	28	29	30	31	32	33	34	35	36	37	38	39	40	
Volume Detector	X	X	X	X	X	X	X	X	X	X	X	X	X	X	X	X	X	X	X	X	X
Occupancy	X	X	X	X	X	X	X	X	X	X	X	X	X	X	X	X	X	X	X	X	X
Yellow Lock Call																					
Red Lock call			X																		
Passage	X	X	X	X	X	X	X	X													
Queue																					
Call	X	X	X	X	X	X	X	X													
Terminate																					

Detector	41	42	43	44	45	46	47	48	49	50	51	52	53	54	55	56	57	58	59	60	
Volume Detector	X	X	X	X	X	X	X	X	X	X	X	X	X	X	X	X	X	X	X	X	X
Occupancy	X	X	X	X	X	X	X	X	X	X	X	X	X	X	X	X	X	X	X	X	X
Yellow Lock Call																					
Red Lock call			X																		
Passage																					
Queue																					
Call																					
Terminate																					

Detector	61	62	63	64	65	66	67	68	69	70	71	72
Volume Detector	X	X	X	X	X	X	X	X	X	X	X	X
Occupancy	X	X	X	X	X	X	X	X	X	X	X	X
Yellow Lock Call												
Red Lock call												
Passage												
Queue												
Call												
Terminate												

Data Collection Period	0
------------------------	---

Pedestrian Detectors

Det	Call Phase	Call Ovlp	No Act	Max Presence	Erratic Count
1	0	0	0	0	0
2	2	0	0	0	0
3	0	0	0	0	0
4	4	0	0	0	0
5	0	0	0	0	0
6	6	0	0	0	0
7	0	0	0	0	0
8	8	0	0	0	0
9	0	0	0	0	0
10	0	0	0	0	0
11	0	0	0	0	0
12	0	0	0	0	0
13	0	0	0	0	0
14	0	0	0	0	0

Det	Call Phase	Call Ovlp	No Act	Max Presence	Erratic Count
21	0	0	0	0	0
22	0	0	0	0	0
23	0	0	0	0	0
24	0	0	0	0	0
25	0	0	0	0	0
26	0	0	0	0	0
27	0	0	0	0	0
28	0	0	0	0	0
29	0	0	0	0	0
30	0	0	0	0	0
31	0	0	0	0	0
32	0	0	0	0	0
33	0	0	0	0	0
34	0	0	0	0	0

15	0	0	0	0	0
16	0	0	0	0	0
17	0	0	0	0	0
18	0	0	0	0	0
19	0	0	0	0	0
20	0	0	0	0	0

35	0	0	0	0	0
36	0	0	0	0	0
37	0	0	0	0	0
38	0	0	0	0	0
39	0	0	0	0	0
40	0	0	0	0	0

Overlaps

OLP	Type	Included Phases	Modifier Phases	Trail		Walk		Ped		Delay	Flash	Descriptions
				GRN	YEL	RED	1	Clr 1	2			
1	Off			0	0.0	0.0	0	0	0	0	0.0	Off
2	Off			0	0.0	0.0	0	0	0	0	0.0	Off
3	FYA - 4 Sec	4	3	0	0.0	0.0	0	0	0	0	0.0	Off
4	Thur FYA Ped	4		0	0.0	0.0	0	0	0	0	0.0	Off
5	Off			0	0.0	0.0	0	0	0	0	0.0	Off
6	Off			0	0.0	0.0	0	0	0	0	0.0	Off
7	FRA - 4 Section	8	7	0	0.0	0.0	0	0	0	0	0.0	Off
8	Thur FYA Ped	8		0	0.0	0.0	0	0	0	0	0.0	Off
9	Off			0	0.0	0.0	0	0	0	0	0.0	Off
10	Off			0	0.0	0.0	0	0	0	0	0.0	Off
11	Off			0	0.0	0.0	0	0	0	0	0.0	Off
12	Off			0	0.0	0.0	0	0	0	0	0.0	Off
13	Off			0	0.0	0.0	0	0	0	0	0.0	Off
14	Off			0	0.0	0.0	0	0	0	0	0.0	Off
15	Off			0	0.0	0.0	0	0	0	0	0.0	Off
16	Off			0	0.0	0.0	0	0	0	0	0.0	Off
17	Off			0	0.0	0.0	0	0	0	0	0.0	Off
18	Off			0	0.0	0.0	0	0	0	0	0.0	Off
19	Off			0	0.0	0.0	0	0	0	0	0.0	Off
20	Off			0	0.0	0.0	0	0	0	0	0.0	Off
21	Off			0	0.0	0.0	0	0	0	0	0.0	Off
22	Off			0	0.0	0.0	0	0	0	0	0.0	Off
23	Off			0	0.0	0.0	0	0	0	0	0.0	Off
24	Off			0	0.0	0.0	0	0	0	0	0.0	Off
25	Off			0	0.0	0.0	0	0	0	0	0.0	Off
26	Off			0	0.0	0.0	0	0	0	0	0.0	Off
27	Off			0	0.0	0.0	0	0	0	0	0.0	Off
28	Off			0	0.0	0.0	0	0	0	0	0.0	Off
29	Off			0	0.0	0.0	0	0	0	0	0.0	Off
30	Off			0	0.0	0.0	0	0	0	0	0.0	Off
31	Off			0	0.0	0.0	0	0	0	0	0.0	Off
32	Off			0	0.0	0.0	0	0	0	0	0.0	Off

Coordination Parameters

Operational Mode	Correction Mode	Maximum Mode	Force Mode
Automatic	Shortway (Auto)	Max Inhibit	Floating

Patterns

Patt.	Cycle	Offset 1	Offset 2	Offset 3	Split	Sequence	Ref. Color	Max Mode	Phs	Det	Ped
									Pln	Pln	Pln
1	120	42	0	0	1	1	Yel	Inh	1	1	1
2	90	62	0	0	2	2	Yel	Inh	1	1	1
3	120	112	0	0	3	3	Yel	Inh	1	1	1
4	100	62	0	0	4	4	Yel	Inh	1	1	1
5	0	0	0	0	0	0	Yel	Inh	1	1	1
6	0	0	0	0	0	0	Yel	Inh	1	1	1
7	0	0	0	0	0	0	Yel	Inh	1	1	1
8	0	0	0	0	0	0	Yel	Inh	1	1	1
9	0	0	0	0	0	0	Yel	Inh	1	1	1
10	0	0	0	0	0	0	Yel	Inh	1	1	1
11	0	0	0	0	0	0	Yel	Inh	1	1	1
12	0	0	0	0	0	0	Yel	Inh	1	1	1
13	0	0	0	0	0	0	Yel	Inh	1	1	1
14	0	0	0	0	0	0	Yel	Inh	1	1	1
15	0	0	0	0	0	0	Yel	Inh	1	1	1
16	0	0	0	0	0	0	Yel	Inh	1	1	1

17	0	0	0	0	0	0	Yel	Inh	1	1	1
18	0	0	0	0	0	0	Yel	Inh	1	1	1
19	0	0	0	0	0	0	Yel	Inh	1	1	1
20	0	0	0	0	20	20	Yel	Max2	1	1	1
21	0	0	0	0	0	0	Yel	Inh	1	1	1
22	0	0	0	0	0	0	Yel	Inh	1	1	1
23	0	0	0	0	0	0	Yel	Inh	1	1	1
24	0	0	0	0	0	0	Yel	Inh	1	1	1
25	0	0	0	0	0	0	Yel	Inh	1	1	1
26	0	0	0	0	0	0	Yel	Inh	1	1	1
27	0	0	0	0	0	0	Yel	Inh	1	1	1
28	0	0	0	0	0	0	Yel	Inh	1	1	1
29	0	0	0	0	0	0	Yel	Inh	1	1	1
30	0	0	0	0	0	0	Yel	Inh	1	1	1
31	0	0	0	0	0	0	Yel	Inh	1	1	1
32	0	0	0	0	0	0	Yel	Inh	1	1	1
33	0	0	0	0	0	0	Yel	Inh	1	1	1
34	0	0	0	0	0	0	Yel	Inh	1	1	1
35	0	0	0	0	0	0	Yel	Inh	1	1	1
36	0	0	0	0	0	0	Yel	Inh	1	1	1
37	0	0	0	0	0	0	Yel	Inh	1	1	1
38	0	0	0	0	0	0	Yel	Inh	1	1	1
39	0	0	0	0	0	0	Yel	Inh	1	1	1
40	0	0	0	0	0	0	Yel	Inh	1	1	1
41	0	0	0	0	0	0	Yel	Inh	1	1	1
42	0	0	0	0	0	0	Yel	Inh	1	1	1
43	0	0	0	0	0	0	Yel	Inh	1	1	1
44	0	0	0	0	0	0	Yel	Inh	1	1	1
45	0	0	0	0	0	0	Yel	Inh	1	1	1
46	0	0	0	0	0	0	Yel	Inh	1	1	1
47	0	0	0	0	0	0	Yel	Inh	1	1	1
48	0	0	0	0	0	0	Yel	Inh	1	1	1
49	0	0	0	0	0	0	Yel	Inh	1	1	1
50	0	0	0	0	0	0	Yel	Inh	1	1	1
51	0	0	0	0	0	0	Yel	Inh	1	1	1
52	0	0	0	0	0	0	Yel	Inh	1	1	1
53	0	0	0	0	0	0	Yel	Inh	1	1	1
54	0	0	0	0	0	0	Yel	Inh	1	1	1
55	0	0	0	0	0	0	Yel	Inh	1	1	1
56	0	0	0	0	0	0	Yel	Inh	1	1	1
57	0	0	0	0	0	0	Yel	Inh	1	1	1
58	0	0	0	0	0	0	Yel	Inh	1	1	1
59	0	0	0	0	0	0	Yel	Inh	1	1	1
60	0	0	0	0	0	0	Yel	Inh	1	1	1
61	0	0	0	0	0	0	Yel	Inh	1	1	1
62	0	0	0	0	0	0	Yel	Inh	1	1	1
63	0	0	0	0	0	0	Yel	Inh	1	1	1
64	0	0	0	0	0	0	Yel	Inh	1	1	1
65	0	0	0	0	0	0	Yel	Inh	1	1	1
66	0	0	0	0	0	0	Yel	Inh	1	1	1
67	0	0	0	0	0	0	Yel	Inh	1	1	1
68	0	0	0	0	0	0	Yel	Inh	1	1	1
69	0	0	0	0	0	0	Yel	Inh	1	1	1
70	0	0	0	0	0	0	Yel	Inh	1	1	1
71	0	0	0	0	0	0	Yel	Inh	1	1	1
72	0	0	0	0	0	0	Yel	Inh	1	1	1
73	0	0	0	0	0	0	Yel	Inh	1	1	1
74	0	0	0	0	0	0	Yel	Inh	1	1	1
75	0	0	0	0	0	0	Yel	Inh	1	1	1
76	0	0	0	0	0	0	Yel	Inh	1	1	1
77	0	0	0	0	0	0	Yel	Inh	1	1	1
78	0	0	0	0	0	0	Yel	Inh	1	1	1
79	0	0	0	0	0	0	Yel	Inh	1	1	1

80	0	0	0	0	0	0	Yel	Inh	1	1	1
81	0	0	0	0	0	0	Yel	Inh	1	1	1
82	0	0	0	0	0	0	Yel	Inh	1	1	1
83	0	0	0	0	0	0	Yel	Inh	1	1	1
84	0	0	0	0	0	0	Yel	Inh	1	1	1
85	0	0	0	0	0	0	Yel	Inh	1	1	1
86	0	0	0	0	0	0	Yel	Inh	1	1	1
87	0	0	0	0	0	0	Yel	Inh	1	1	1
88	0	0	0	0	0	0	Yel	Inh	1	1	1
89	0	0	0	0	0	0	Yel	Inh	1	1	1
90	0	0	0	0	0	0	Yel	Inh	1	1	1
91	0	0	0	0	0	0	Yel	Inh	1	1	1
92	0	0	0	0	0	0	Yel	Inh	1	1	1
93	0	0	0	0	0	0	Yel	Inh	1	1	1
94	0	0	0	0	0	0	Yel	Inh	1	1	1
95	0	0	0	0	0	0	Yel	Inh	1	1	1
96	0	0	0	0	0	0	Yel	Inh	1	1	1
97	0	0	0	0	0	0	Yel	Inh	1	1	1
98	0	0	0	0	0	0	Yel	Inh	1	1	1
99	0	0	0	0	0	0	Yel	Inh	1	1	1
100	0	0	0	0	0	0	Yel	Inh	1	1	1
101	0	0	0	0	0	0	Yel	Inh	1	1	1
102	0	0	0	0	0	0	Yel	Inh	1	1	1
103	0	0	0	0	0	0	Yel	Inh	1	1	1
104	0	0	0	0	0	0	Yel	Inh	1	1	1
105	0	0	0	0	0	0	Yel	Inh	1	1	1
106	0	0	0	0	0	0	Yel	Inh	1	1	1
107	0	0	0	0	0	0	Yel	Inh	1	1	1
108	0	0	0	0	0	0	Yel	Inh	1	1	1
109	0	0	0	0	0	0	Yel	Inh	1	1	1
110	0	0	0	0	0	0	Yel	Inh	1	1	1
111	0	0	0	0	0	0	Yel	Inh	1	1	1
112	0	0	0	0	0	0	Yel	Inh	1	1	1
113	0	0	0	0	0	0	Yel	Inh	1	1	1
114	0	0	0	0	0	0	Yel	Inh	1	1	1
115	0	0	0	0	0	0	Yel	Inh	1	1	1
116	0	0	0	0	0	0	Yel	Inh	1	1	1
117	0	0	0	0	0	0	Yel	Inh	1	1	1
118	0	0	0	0	0	0	Yel	Inh	1	1	1
119	0	0	0	0	0	0	Yel	Inh	1	1	1
120	0	0	0	0	0	0	Yel	Inh	1	1	1
121	0	0	0	0	0	0	Yel	Inh	1	1	1
122	0	0	0	0	0	0	Yel	Inh	1	1	1
123	0	0	0	0	0	0	Yel	Inh	1	1	1
124	0	0	0	0	0	0	Yel	Inh	1	1	1
125	0	0	0	0	0	0	Yel	Inh	1	1	1
126	0	0	0	0	0	0	Yel	Inh	1	1	1
127	0	0	0	0	0	0	Yel	Inh	1	1	1
128	0	0	0	0	0	0	Yel	Inh	1	1	1

Split Parameters

Split 1		Coord	Ref	
PH.	Time	PH	PH	Mode
1	10			None
2	80	X	X	None
3	18			None
4	12			None
5	10			None
6	80	X	X	None
7	11			None
8	19			None
9	0			None
10	0			None
11	0			None

Split 2		Coord	Ref	
PH.	Time	PH	PH	Mode
1	12			None
2	47	X	X	None
3	15			None
4	16			None
5	18			None
6	41	X	X	None
7	18			None
8	13			None
9	0			None
10	0			None
11	0			None

12	0			None
13	0			None
14	0			None
15	0			None
16	0			None

12	0			None
13	0			None
14	0			None
15	0			None
16	0			None

Split 3

PH.	Time	Coord		Ref	Mode
		PH	PH		
1	11				None
2	83	X	X		None
3	13				None
4	13				None
5	20				None
6	74	X	X		None
7	13				None
8	13				None
9	0				None
10	0				None
11	0				None
12	0				None
13	0				None
14	0				None
15	0				None
16	0				None

Split 4

PH.	Time	Coord		Ref	Mode
		PH	PH		
1	12				None
2	55	X	X		None
3	20				None
4	13				None
5	15				None
6	52	X	X		None
7	14				None
8	19				None
9	0				None
10	0				None
11	0				None
12	0				None
13	0				None
14	0				None
15	0				None
16	0				None

Split 5

PH.	Time	Coord		Ref	Mode
		PH	PH		
1	0				None
2	0				None
3	0				None
4	0				None
5	0				None
6	0				None
7	0				None
8	0				None
9	0				None
10	0				None
11	0				None
12	0				None
13	0				None
14	0				None
15	0				None
16	0				None

Split 6

PH.	Time	Coord		Ref	Mode
		PH	PH		
1	0				None
2	0				None
3	0				None
4	0				None
5	0				None
6	0				None
7	0				None
8	0				None
9	0				None
10	0				None
11	0				None
12	0				None
13	0				None
14	0				None
15	0				None
16	0				None

Split 7

PH.	Time	Coord		Ref	Mode
		PH	PH		
1	0				None
2	0				None
3	0				None
4	0				None
5	0				None
6	0				None
7	0				None
8	0				None
9	0				None
10	0				None
11	0				None
12	0				None
13	0				None
14	0				None
15	0				None
16	0				None

Split 8

PH.	Time	Coord		Ref	Mode
		PH	PH		
1	0				None
2	0				None
3	0				None
4	0				None
5	0				None
6	0				None
7	0				None
8	0				None
9	0				None
10	0				None
11	0				None
12	0				None
13	0				None
14	0				None
15	0				None
16	0				None

Split 9

Split 10

PH.	Time	Coord PH	Ref PH	Mode
1	0			None
2	0			None
3	0			None
4	0			None
5	0			None
6	0			None
7	0			None
8	0			None
9	0			None

PH.	Time	Coord PH	Ref PH	Mode
1	0			None
2	0			None
3	0			None
4	0			None
5	0			None
6	0			None
7	0			None
8	0			None
9	0			None

Split 9

PH.	Time	Coord PH	Ref PH	Mode
10	0			None
11	0			None
12	0			None
13	0			None
14	0			None
15	0			None
16	0			None

Split 10

PH.	Time	Coord PH	Ref PH	Mode
10	0			None
11	0			None
12	0			None
13	0			None
14	0			None
15	0			None
16	0			None

Split 11

PH.	Time	Coord PH	Ref PH	Mode
1	0			None
2	0			None
3	0			None
4	0			None
5	0			None
6	0			None
7	0			None
8	0			None
9	0			None
10	0			None
11	0			None
12	0			None
13	0			None
14	0			None
15	0			None
16	0			None

Split 12

PH.	Time	Coord PH	Ref PH	Mode
1	0			None
2	0			None
3	0			None
4	0			None
5	0			None
6	0			None
7	0			None
8	0			None
9	0			None
10	0			None
11	0			None
12	0			None
13	0			None
14	0			None
15	0			None
16	0			None

Split 13

PH.	Time	Coord PH	Ref PH	Mode
1	0			None
2	0			None
3	0			None
4	0			None
5	0			None
6	0			None
7	0			None
8	0			None
9	0			None
10	0			None
11	0			None
12	0			None
13	0			None
14	0			None
15	0			None
16	0			None

Split 14

PH.	Time	Coord PH	Ref PH	Mode
1	0			None
2	0			None
3	0			None
4	0			None
5	0			None
6	0			None
7	0			None
8	0			None
9	0			None
10	0			None
11	0			None
12	0			None
13	0			None
14	0			None
15	0			None
16	0			None

Split 15

PH.	Time	Coord PH	Ref PH	Mode
1	0			None
2	0			None

Split 16

PH.	Time	Coord PH	Ref PH	Mode
1	0			None
2	0			None

3	0			None
4	0			None
5	0			None
6	0			None
7	0			None
8	0			None
9	0			None
10	0			None
11	0			None
12	0			None
13	0			None
14	0			None
15	0			None
16	0			None

3	0			None
4	0			None
5	0			None
6	0			None
7	0			None
8	0			None
9	0			None
10	0			None
11	0			None
12	0			None
13	0			None
14	0			None
15	0			None
16	0			None

Split 17		Coord	Ref	
PH.	Time	PH	PH	Mode
1	0			None
2	0			None
3	0			None
4	0			None
5	0			None
6	0			None
7	0			None
8	0			None
9	0			None
10	0			None
11	0			None
12	0			None
13	0			None
14	0			None
15	0			None
16	0			None

Split 18		Coord	Ref	
PH.	Time	PH	PH	Mode
1	0			None
2	0			None
3	0			None
4	0			None
5	0			None
6	0			None
7	0			None
8	0			None
9	0			None
10	0			None
11	0			None
12	0			None
13	0			None
14	0			None
15	0			None
16	0			None

Split 19		Coord	Ref	
PH.	Time	PH	PH	Mode
1	0			None
2	0			None
3	0			None
4	0			None
5	0			None
6	0			None

Split 20		Coord	Ref	
PH.	Time	PH	PH	Mode
1	0			None
2	0	X	X	None
3	0			None
4	0			None
5	0			None
6	0	X	X	None

Split 19		Coord	Ref	
PH.	Time	PH	PH	Mode
7	0			None
8	0			None
9	0			None
10	0			None
11	0			None
12	0			None
13	0			None
14	0			None
15	0			None
16	0			None

Split 20		Coord	Ref	
PH.	Time	PH	PH	Mode
7	0			None
8	0			None
9	0			None
10	0			None
11	0			None
12	0			None
13	0			None
14	0			None
15	0			None
16	0			None

Ring	1	2	3	4	5	6	7	8	9	10	11	12	13	14	15	16
Offset																

Day Plan	1																											
Month of Year	Days of Week		Days of Month																									
J	F	M	A	M	J	S	M	T	W	T	F	S	1	2	3	4	5	6	7	8	9	10	11	12	13	14	15	16

X	X	X	X	X	X	X	X	X	X	X	X	X	X	X	X	X	X	X	X	X	X	X		
J	A	S	O	N	D					17	18	19	20	21	22	23	24	25	26	27	28	29	30	31
X	X	X	X	X	X					X	X	X	X	X	X	X	X	X	X	X	X	X	X	X

Day Plan 2

Month of Year	Days of Week	Days of Month
J F M A M J	S M T W T F S	1 2 3 4 5 6 7 8 9 10 11 12 13 14 15 16
X X X X X X	X X X X X X X	X X X X X X X X X X X X X X X X
J A S O N D		17 18 19 20 21 22 23 24 25 26 27 28 29 30 31
X X X X X X		X X X X X X X X X X X X X X X

Day Plan 3

Month of Year	Days of Week	Days of Month
J F M A M J	S M T W T F S	1 2 3 4 5 6 7 8 9 10 11 12 13 14 15 16
X X X X X X	X X X X X X X	X X X X X X X X X X X X X X X
J A S O N D		17 18 19 20 21 22 23 24 25 26 27 28 29 30 31
X X X X X X		X X X X X X X X X X X X X X X

Day Plan 4

Month of Year	Days of Week	Days of Month
J F M A M J	S M T W T F S	1 2 3 4 5 6 7 8 9 10 11 12 13 14 15 16
X X X X X X	X X X X X X X	X X X X X X X X X X X X X X X
J A S O N D		17 18 19 20 21 22 23 24 25 26 27 28 29 30 31
X X X X X X		X X X X X X X X X X X X X X X

Day Plan 5

Month of Year	Days of Week	Days of Month
J F M A M J	S M T W T F S	1 2 3 4 5 6 7 8 9 10 11 12 13 14 15 16
X X X X X X	X X X X X X X	X X X X X X X X X X X X X X X
J A S O N D		17 18 19 20 21 22 23 24 25 26 27 28 29 30 31
X X X X X X		X X X X X X X X X X X X X X X

Day Plan 6

Month of Year	Days of Week	Days of Month
J F M A M J	S M T W T F S	1 2 3 4 5 6 7 8 9 10 11 12 13 14 15 16
X X X X X X	X X X X X X X	X X X X X X X X X X X X X X X
J A S O N D		17 18 19 20 21 22 23 24 25 26 27 28 29 30 31
X X X X X X		X X X X X X X X X X X X X X X

Day Plan 7

Month of Year	Days of Week	Days of Month
J F M A M J	S M T W T F S	1 2 3 4 5 6 7 8 9 10 11 12 13 14 15 16
X X X X X X	X X X X X X X	X X X X X X X X X X X X X X X
J A S O N D		17 18 19 20 21 22 23 24 25 26 27 28 29 30 31
X X X X X X		X X X X X X X X X X X X X X X

Day Plan 8

Month of Year	Days of Week	Days of Month
J F M A M J	S M T W T F S	1 2 3 4 5 6 7 8 9 10 11 12 13 14 15 16
X X X X X X	X X X X X X X	X X X X X X X X X X X X X X X
J A S O N D		17 18 19 20 21 22 23 24 25 26 27 28 29 30 31
X X X X X X		X X X X X X X X X X X X X X X

Day Plan 9

Month of Year	Days of Week	Days of Month
J F M A M J	S M T W T F S	1 2 3 4 5 6 7 8 9 10 11 12 13 14 15 16
X X X X X X	X X X X X X X	X X X X X X X X X X X X X X X
J A S O N D		17 18 19 20 21 22 23 24 25 26 27 28 29 30 31
X X X X X X		X X X X X X X X X X X X X X X

Day Plan 10

Month of Year	Days of Week	Days of Month
J F M A M J	S M T W T F S	1 2 3 4 5 6 7 8 9 10 11 12 13 14 15 16
X X X X X X	X X X X X X X	X X X X X X X X X X X X X X X

J	A	S	O	N	D
X	X	X	X	X	X

17	18	19	20	21	22	23	24	25	26	27	28	29	30	31
X	X	X	X	X	X	X	X	X	X	X	X	X	X	X

Day Plan 11

Month of Year						Days of Week							Days of Month																
J	F	M	A	M	J	S	M	T	W	T	F	S	1	2	3	4	5	6	7	8	9	10	11	12	13	14	15	16	
J	A	S	O	N	D								17	18	19	20	21	22	23	24	25	26	27	28	29	30	31		

Day Plan 12

Month of Year						Days of Week							Days of Month																
J	F	M	A	M	J	S	M	T	W	T	F	S	1	2	3	4	5	6	7	8	9	10	11	12	13	14	15	16	
J	A	S	O	N	D								17	18	19	20	21	22	23	24	25	26	27	28	29	30	31		

Day Plan 13

Month of Year						Days of Week							Days of Month																
J	F	M	A	M	J	S	M	T	W	T	F	S	1	2	3	4	5	6	7	8	9	10	11	12	13	14	15	16	
J	A	S	O	N	D								17	18	19	20	21	22	23	24	25	26	27	28	29	30	31		

Day Plan 14

Month of Year						Days of Week							Days of Month																
J	F	M	A	M	J	S	M	T	W	T	F	S	1	2	3	4	5	6	7	8	9	10	11	12	13	14	15	16	
J	A	S	O	N	D								17	18	19	20	21	22	23	24	25	26	27	28	29	30	31		

Day Plan 15

Month of Year						Days of Week							Days of Month																
J	F	M	A	M	J	S	M	T	W	T	F	S	1	2	3	4	5	6	7	8	9	10	11	12	13	14	15	16	
J	A	S	O	N	D								17	18	19	20	21	22	23	24	25	26	27	28	29	30	31		

Day Plan 1

Event	Hour	Min.	Act
1	6	0	1
2	9	0	2
3	15	0	3
4	19	0	2
5	22	0	20

Day Plan 2

Event	Hour	Min.	Act
1	6	0	1
2	9	0	4
3	21	0	20
4	0	0	
5	0	0	

Day Plan 3

Event	Hour	Min.	Act
1	0	0	
2	0	0	
3	0	0	
4	0	0	
5	0	0	

Day Plan 4

Event	Hour	Min.	Act
1	0	0	
2	0	0	
3	0	0	
4	0	0	
5	0	0	

Day Plan 1

Event	Hour	Min.	Act
6	0	0	
7	0	0	
8	0	0	
9	0	0	
10	0	0	

Day Plan 2

Event	Hour	Min.	Act
6	0	0	
7	0	0	
8	0	0	
9	0	0	
10	0	0	

Day Plan 3

Event	Hour	Min.	Act
6	0	0	
7	0	0	
8	0	0	
9	0	0	
10	0	0	

Day Plan 4

Event	Hour	Min.	Act
6	0	0	
7	0	0	
8	0	0	
9	0	0	
10	0	0	

Day Plan 5

Event	Hour	Min.	Act
1	0	0	
2	0	0	
3	0	0	
4	0	0	
5	0	0	
6	0	0	

Day Plan 6

Event	Hour	Min.	Act
1	0	0	
2	0	0	
3	0	0	
4	0	0	
5	0	0	
6	0	0	

Day Plan 7

Event	Hour	Min.	Act
1	0	0	
2	0	0	
3	0	0	
4	0	0	
5	0	0	
6	0	0	

Day Plan 8

Event	Hour	Min.	Act
1	0	0	
2	0	0	
3	0	0	
4	0	0	
5	0	0	
6	0	0	

7	0	0	
8	0	0	
9	0	0	
10	0	0	

7	0	0	
8	0	0	
9	0	0	
10	0	0	

7	0	0	
8	0	0	
9	0	0	
10	0	0	

7	0	0	
8	0	0	
9	0	0	
10	0	0	

Day Plan 9

Day Plan 10

Day Plan 11

Day Plan 12

Event	Hour	Min.	Act
1	0	0	
2	0	0	
3	0	0	
4	0	0	
5	0	0	
6	0	0	
7	0	0	
8	0	0	
9	0	0	
10	0	0	

Event	Hour	Min.	Act
1	0	0	
2	0	0	
3	0	0	
4	0	0	
5	0	0	
6	0	0	
7	0	0	
8	0	0	
9	0	0	
10	0	0	

Event	Hour	Min.	Act
1	0	0	
2	0	0	
3	0	0	
4	0	0	
5	0	0	
6	0	0	
7	0	0	
8	0	0	
9	0	0	
10	0	0	

Event	Hour	Min.	Act
1	0	0	
2	0	0	
3	0	0	
4	0	0	
5	0	0	
6	0	0	
7	0	0	
8	0	0	
9	0	0	
10	0	0	

Day Plan 13

Day Plan 14

Day Plan 15

Day Plan 16

Event	Hour	Min.	Act
1	0	0	
2	0	0	
3	0	0	
4	0	0	
5	0	0	
6	0	0	
7	0	0	
8	0	0	
9	0	0	
10	0	0	

Event	Hour	Min.	Act
1	0	0	
2	0	0	
3	0	0	
4	0	0	
5	0	0	
6	0	0	
7	0	0	
8	0	0	
9	0	0	
10	0	0	

Event	Hour	Min.	Act
1	0	0	
2	0	0	
3	0	0	
4	0	0	
5	0	0	
6	0	0	
7	0	0	
8	0	0	
9	0	0	
10	0	0	

Event	Hour	Min.	Act
1	0	0	
2	0	0	
3	0	0	
4	0	0	
5	0	0	
6	0	0	
7	0	0	
8	0	0	
9	0	0	
10	0	0	

Day Plan 17

Day Plan 18

Day Plan 19

Day Plan 20

Event	Hour	Min.	Act
1	0	0	
2	0	0	
3	0	0	
4	0	0	
5	0	0	
6	0	0	
7	0	0	
8	0	0	
9	0	0	
10	0	0	

Event	Hour	Min.	Act
1	0	0	
2	0	0	
3	0	0	
4	0	0	
5	0	0	
6	0	0	
7	0	0	
8	0	0	
9	0	0	
10	0	0	

Event	Hour	Min.	Act
1	0	0	
2	0	0	
3	0	0	
4	0	0	
5	0	0	
6	0	0	
7	0	0	
8	0	0	
9	0	0	
10	0	0	

Event	Hour	Min.	Act
1	0	0	
2	0	0	
3	0	0	
4	0	0	
5	0	0	
6	0	0	
7	0	0	
8	0	0	
9	0	0	
10	0	0	

Actions

Act	Pattern	Aux.			Special Functions									
		1	2	3	1	2	3	4	5	6	7	8		
1	Pattern 1													
2	Pattern 2													
3	Pattern 3													
4	Pattern 4													
5	Pattern 5													
6	Pattern 6													
7	Pattern 7													
8	Pattern 8													
9	Pattern 9													
10	Pattern 10													
11	None													
12	None													
13	None													
14	None													
15	None													
16	None													
17	None													
18	None													
19	None													

Actions

Act	Pattern	Aux.			Special Functions									
		1	2	3	1	2	3	4	5	6	7	8		
33	None													
34	None													
35	None													
36	None													
37	None													
38	None													
39	None													
40	None													
41	None													
42	None													
43	None													
44	None													
45	None													
46	None													
47	None													
48	None													
49	None													
50	None													
51	None													

20	None																		
21	None																		
22	None																		
23	None																		
24	None																		
25	None																		
26	None																		
27	None																		
28	None																		
29	None																		
30	None																		
31	None																		
32	None																		

52	None																		
53	None																		
54	None																		
55	None																		
56	None																		
57	None																		
58	None																		
59	None																		
60	None																		
61	None																		
62	None																		
63	None																		
64	None																		

Preemption Parameters

Preempt	1	2	3	4	5	6	7	8
Link	0	0	0	0	0	0	0	0
Delay	0	0	0	0	0	0	0	0
Min Duration	0	0	10	10	10	10	0	0
Min Green	0	0	0	0	0	0	0	0
Min Walk	0	0	0	0	0	0	0	0
Ent. Ped Clear	255	255	255	255	255	255	255	255
Track Green	0	0	0	0	0	0	0	0
Dwell Green	0	0	5	5	5	5	0	0
Max Presence	0	0	0	0	0	0	0	0
Enter Yellow	25.5	25.5	25.5	25.5	25.5	25.5	25.5	25.5
Ent. Red Clear	25.5	25.5	25.5	25.5	25.5	25.5	25.5	25.5

Preemption Parameters

Preempt	1	2	3	4	5	6	7	8
Track Yellow	25.5	25.5	25.5	25.5	25.5	25.5	25.5	25.5
Track Red Clear	25.5	25.5	25.5	25.5	25.5	25.5	25.5	25.5
Exit Red	25.5	25.5	25.5	25.5	25.5	25.5	25.5	25.5
Exit Ped Clear	255	255	255	255	255	255	255	255
Exit Yellow	25.5	25.5	25.5	25.5	25.5	25.5	25.5	25.5
Exit Red	25.5	25.5	25.5	25.5	25.5	25.5	25.5	25.5
Preempt	1	2	3	4	5	6	7	8
Non Lock Mem								
Not Override Flash								
NotOverrideNextPre								
Flash Dwell								

Preemption Configuration

Preempt	1	2	3	4	5	6	7	8
Track phase								
Dwell Phase			4,7	1,6	3,8	2,5		
Dwell Ped								
Exit Phase								
Track Overlap								
Dwell overlap								
Cycling phase								
Cycling Ped								
Cycling Overlap								

IO Modules

IO Mod	TYPE
1	Caltrans 332
2	None
3	None
4	None
5	None
6	None
7	None
8	None
9	None
10	None

Channel Configuration

Chan	Ctrl Type	Source
1	Phs Veh	1
2	Phs Veh	2
3	Olp	3
4	Olp	4
5	Phs Veh	5
6	Phs Veh	6
7	Olp	7
8	Olp	8
9	Olp	1
10	Olp	2

Chan	Ctrl Type	Source
11	Olp	3
12	Olp	4
13	Phs Ped	2
14	Phs Ped	4
15	Phs Ped	6
16	Phs Ped	8
17	Olp	5
18	Olp	6
19	None	0
20	None	0

Channel Options

Channel	1	2	3	4	5	6	7	8	9	10	11	12	13	14	15	16
Flash Yellow																
Flash Red	X	X	X	X	X	X	X	X								
Alt Flash	X			X	X			X								
Channel	17	18	19	20	21	22	23	24	25	26	27	28	29	30	31	32
Flash Yellow																
Flash Red																
Alt Flash																

Startup Clearance Hold Type

1=off, 2=On, 3=Flash and 4= Alt Flash

Channel	1	2	3	4	5	6	7	8	9	10	11	12	13	14	15	16
Red																
Yellow																
Green																
Channel	17	18	19	20	21	22	23	24	25	26	27	28	29	30	31	32
Red																
Yellow																
Green																

Phase Intervals

Interval	Description	Red	Yel	Grn	Type
1	notActive	On	Off	Off	Red
2	dltGrn	On	Off	Off	Red
3	PreGrn	Off	Off	On	Green
4	minGrn	Off	Off	On	Green
5	grnExt	Off	Off	On	Green
6	grnDwell	Off	Off	On	Green
7	preClear	Off	Off	On	Green
8	yelChange	Off	On	Off	Yellow
9	redClear	On	Off	Off	Red
10	redDwell	On	Off	Off	Red
11	Barrier	On	Off	Off	Red
12					

Pedestrian Intervals

Interval	Description	DWK	CLR	Wlk	Type
1	notActive	On	Off	Off	Dont Walk
2	dltPed	On	Off	Off	Dont Walk
3	walk	Off	Off	On	Walk
4	walkDwell	Off	Off	On	Walk
5	flashDtWlk	Flash	Off	Off	Ped Clear
6	dWalk	On	Off	Off	Dont Walk
7					
8					

Countdown Display

Display	Addr	Phase	Time
1			
2			
3			
4			
5			
6			
7			
8			

Display	Addr	Phase	Time
9			
10			
11			
12			
13			
14			
15			
16			

Display	Addr	Phase	Time
17			
18			
19			
20			
21			
22			
23			
24			

Display	Addr	Phase	Time
25			
26			
27			
28			
29			
30			
31			
32			

Manual Control Phase Groups

Grp 1	Grp 2	Grp 3	Grp 4	Grp 5	Grp 6	Grp 7	Grp 8
Ring	Ph	Ring	Ph	Ring	Ph	Ring	Ph
1	0	1	0	1	0	1	0
2	0	2	0	2	0	2	0
3	0	3	0	3	0	3	0
4	0	4	0	4	0	4	0
5	0	5	0	5	0	5	0
6	0	6	0	6	0	6	0
7	0	7	0	7	0	7	0
8	0	8	0	8	0	8	0
9	0	9	0	9	0	9	0
10	0	10	0	10	0	10	0
11	0	11	0	11	0	11	0
12	0	12	0	12	0	12	0
13	0	13	0	13	0	13	0
14	0	14	0	14	0	14	0
15	0	15	0	15	0	15	0
16	0	16	0	16	0	16	0

Prioritor Settings

Prioritor	Priority Ph	Output Dly
1		0
2		0
3		0
4		0
5		0

Enabled	Lock Out Time
No	0

6		0
7		0
8		0

Loopback Functions

Func	Result Function Type	Index	Source Function Type	Index	Func	Result Function Type	Index	Source Function Type	Index
1					51				
2					52				
3					53				
4					54				
5					55				
6					56				
7					57				
8					58				
9					59				
10					60				
11					61				
12					62				
13					63				
14					64				
15					65				
16					66				
17					67				
18					68				
19					69				
20					70				
21					71				
22					72				
23					73				
24					74				
25					75				
26					76				
27					77				
28					78				
29					79				
30					80				
31					81				
32					82				
33					83				
34					84				
35					85				
36					86				
37					87				
38					88				
39					89				
40					90				
41					91				
42					92				
43					93				
44					94				
45					95				
46					96				
47					97				
48					98				
49					99				
50					100				

Peer Configuration

Ctrl	Peer ID	IP address	SNMP Port	Hot Port	Serial Port	Serial Addr.	Master Sect.	P2P TO	Description
1	0		161	80	0	0	0	15	
2	0		161	80	0	0	0	15	
3	0		161	80	0	0	0	15	

4	0		161	80	0	0	0	15	
5	0		161	80	0	0	0	15	
6	0		161	80	0	0	0	15	
7	0		161	80	0	0	0	15	
8	0		161	80	0	0	0	15	
9	0		161	80	0	0	0	15	
10	0		161	80	0	0	0	15	
11	0		161	80	0	0	0	15	
12	0		161	80	0	0	0	15	
13	0		161	80	0	0	0	15	
14	0		161	80	0	0	0	15	
15	0		161	80	0	0	0	15	
16	0		161	80	0	0	0	15	
17	0		161	80	0	0	0	15	
18	0		161	80	0	0	0	15	
19	0		161	80	0	0	0	15	
20	0		161	80	0	0	0	15	
21	0		161	80	0	0	0	15	
22	0		161	80	0	0	0	15	
23	0		161	80	0	0	0	15	
24	0		161	80	0	0	0	15	
25	0		161	80	0	0	0	15	
26	0		161	80	0	0	0	15	
27	0		161	80	0	0	0	15	
28	0		161	80	0	0	0	15	
29	0		161	80	0	0	0	15	
30	0		161	80	0	0	0	15	
31	0		161	80	0	0	0	15	
32	0		161	80	0	0	0	15	
33	0		161	80	0	0	0	15	
34	0		161	80	0	0	0	15	
35	0		161	80	0	0	0	15	
36	0		161	80	0	0	0	15	
37	0		161	80	0	0	0	15	
38	0		161	80	0	0	0	15	
39	0		161	80	0	0	0	15	
40	0		161	80	0	0	0	15	
41	0		161	80	0	0	0	15	
42	0		161	80	0	0	0	15	
43	0		161	80	0	0	0	15	
44	0		161	80	0	0	0	15	
45	0		161	80	0	0	0	15	
46	0		161	80	0	0	0	15	
47	0		161	80	0	0	0	15	
48	0		161	80	0	0	0	15	
49	0		161	80	0	0	0	15	
50	0		161	80	0	0	0	15	
51	0		161	80	0	0	0	15	
52	0		161	80	0	0	0	15	
53	0		161	80	0	0	0	15	
54	0		161	80	0	0	0	15	
55	0		161	80	0	0	0	15	
56	0		161	80	0	0	0	15	
57	0		161	80	0	0	0	15	
58	0		161	80	0	0	0	15	
59	0		161	80	0	0	0	15	
60	0		161	80	0	0	0	15	
61	0		161	80	0	0	0	15	
62	0		161	80	0	0	0	15	
63	0		161	80	0	0	0	15	
64	0		161	80	0	0	0	15	
65	0		161	80	0	0	0	15	
66	0		161	80	0	0	0	15	
67	0		161	80	0	0	0	15	

68	0		161	80	0	0	0	15	
69	0		161	80	0	0	0	15	
70	0		161	80	0	0	0	15	
71	0		161	80	0	0	0	15	
72	0		161	80	0	0	0	15	
73	0		161	80	0	0	0	15	
74	0		161	80	0	0	0	15	
75	0		161	80	0	0	0	15	
76	0		161	80	0	0	0	15	
77	0		161	80	0	0	0	15	
78	0		161	80	0	0	0	15	
79	0		161	80	0	0	0	15	
80	0		161	80	0	0	0	15	
81	0		161	80	0	0	0	15	
82	0		161	80	0	0	0	15	
83	0		161	80	0	0	0	15	
84	0		161	80	0	0	0	15	
85	0		161	80	0	0	0	15	
86	0		161	80	0	0	0	15	
87	0		161	80	0	0	0	15	
88	0		161	80	0	0	0	15	
89	0		161	80	0	0	0	15	
90	0		161	80	0	0	0	15	
91	0		161	80	0	0	0	15	
92	0		161	80	0	0	0	15	
93	0		161	80	0	0	0	15	
94	0		161	80	0	0	0	15	
95	0		161	80	0	0	0	15	
96	0		161	80	0	0	0	15	
97	0		161	80	0	0	0	15	
98	0		161	80	0	0	0	15	
99	0		161	80	0	0	0	15	
100	0		161	80	0	0	0	15	
101	0		161	80	0	0	0	15	
102	0		161	80	0	0	0	15	
103	0		161	80	0	0	0	15	
104	0		161	80	0	0	0	15	
105	0		161	80	0	0	0	15	
106	0		161	80	0	0	0	15	
107	0		161	80	0	0	0	15	
108	0		161	80	0	0	0	15	
109	0		161	80	0	0	0	15	
110	0		161	80	0	0	0	15	
111	0		161	80	0	0	0	15	
112	0		161	80	0	0	0	15	
113	0		161	80	0	0	0	15	
114	0		161	80	0	0	0	15	
115	0		161	80	0	0	0	15	
116	0		161	80	0	0	0	15	
117	0		161	80	0	0	0	15	
118	0		161	80	0	0	0	15	
119	0		161	80	0	0	0	15	
120	0		161	80	0	0	0	15	
121	0		161	80	0	0	0	15	
122	0		161	80	0	0	0	15	
123	0		161	80	0	0	0	15	
124	0		161	80	0	0	0	15	
125	0		161	80	0	0	0	15	
126	0		161	80	0	0	0	15	
127	0		161	80	0	0	0	15	
128	0		161	80	0	0	0	15	
129	0		161	80	0	0	0	15	
130	0		161	80	0	0	0	15	

131	0		161	80	0	0	0	15	
132	0		161	80	0	0	0	15	
133	0		161	80	0	0	0	15	
134	0		161	80	0	0	0	15	
135	0		161	80	0	0	0	15	
136	0		161	80	0	0	0	15	
137	0		161	80	0	0	0	15	
138	0		161	80	0	0	0	15	
139	0		161	80	0	0	0	15	
140	0		161	80	0	0	0	15	
141	0		161	80	0	0	0	15	
142	0		161	80	0	0	0	15	
143	0		161	80	0	0	0	15	
144	0		161	80	0	0	0	15	
145	0		161	80	0	0	0	15	
146	0		161	80	0	0	0	15	
147	0		161	80	0	0	0	15	
148	0		161	80	0	0	0	15	
149	0		161	80	0	0	0	15	
150	0		161	80	0	0	0	15	
151	0		161	80	0	0	0	15	
152	0		161	80	0	0	0	15	
153	0		161	80	0	0	0	15	
154	0		161	80	0	0	0	15	
155	0		161	80	0	0	0	15	
156	0		161	80	0	0	0	15	
157	0		161	80	0	0	0	15	
158	0		161	80	0	0	0	15	
159	0		161	80	0	0	0	15	
160	0		161	80	0	0	0	15	
161	0		161	80	0	0	0	15	
162	0		161	80	0	0	0	15	
163	0		161	80	0	0	0	15	
164	0		161	80	0	0	0	15	
165	0		161	80	0	0	0	15	
166	0		161	80	0	0	0	15	
167	0		161	80	0	0	0	15	
168	0		161	80	0	0	0	15	
169	0		161	80	0	0	0	15	
170	0		161	80	0	0	0	15	
171	0		161	80	0	0	0	15	
172	0		161	80	0	0	0	15	
173	0		161	80	0	0	0	15	
174	0		161	80	0	0	0	15	
175	0		161	80	0	0	0	15	
176	0		161	80	0	0	0	15	
177	0		161	80	0	0	0	15	
178	0		161	80	0	0	0	15	
179	0		161	80	0	0	0	15	
180	0		161	80	0	0	0	15	
181	0		161	80	0	0	0	15	
182	0		161	80	0	0	0	15	
183	0		161	80	0	0	0	15	
184	0		161	80	0	0	0	15	
185	0		161	80	0	0	0	15	
186	0		161	80	0	0	0	15	
187	0		161	80	0	0	0	15	
188	0		161	80	0	0	0	15	
189	0		161	80	0	0	0	15	
190	0		161	80	0	0	0	15	
191	0		161	80	0	0	0	15	
192	0		161	80	0	0	0	15	
193	0		161	80	0	0	0	15	
194	0		161	80	0	0	0	15	

195	0		161	80	0	0	0	15	
196	0		161	80	0	0	0	15	
197	0		161	80	0	0	0	15	
198	0		161	80	0	0	0	15	
199	0		161	80	0	0	0	15	
200	0		161	80	0	0	0	15	
201	0		161	80	0	0	0	15	
202	0		161	80	0	0	0	15	
203	0		161	80	0	0	0	15	
204	0		161	80	0	0	0	15	
205	0		161	80	0	0	0	15	
206	0		161	80	0	0	0	15	
207	0		161	80	0	0	0	15	
208	0		161	80	0	0	0	15	
209	0		161	80	0	0	0	15	
210	0		161	80	0	0	0	15	
211	0		161	80	0	0	0	15	
212	0		161	80	0	0	0	15	
213	0		161	80	0	0	0	15	
214	0		161	80	0	0	0	15	
215	0		161	80	0	0	0	15	
216	0		161	80	0	0	0	15	
217	0		161	80	0	0	0	15	
218	0		161	80	0	0	0	15	
219	0		161	80	0	0	0	15	
220	0		161	80	0	0	0	15	
221	0		161	80	0	0	0	15	
222	0		161	80	0	0	0	15	
223	0		161	80	0	0	0	15	
224	0		161	80	0	0	0	15	
225	0		161	80	0	0	0	15	
226	0		161	80	0	0	0	15	
227	0		161	80	0	0	0	15	
228	0		161	80	0	0	0	15	
229	0		161	80	0	0	0	15	
230	0		161	80	0	0	0	15	
231	0		161	80	0	0	0	15	
232	0		161	80	0	0	0	15	
233	0		161	80	0	0	0	15	
234	0		161	80	0	0	0	15	
235	0		161	80	0	0	0	15	
236	0		161	80	0	0	0	15	
237	0		161	80	0	0	0	15	
238	0		161	80	0	0	0	15	
239	0		161	80	0	0	0	15	
240	0		161	80	0	0	0	15	
241	0		161	80	0	0	0	15	
242	0		161	80	0	0	0	15	
243	0		161	80	0	0	0	15	
244	0		161	80	0	0	0	15	
245	0		161	80	0	0	0	15	
246	0		161	80	0	0	0	15	
247	0		161	80	0	0	0	15	
248	0		161	80	0	0	0	15	
249	0		161	80	0	0	0	15	
250	0		161	80	0	0	0	15	
251	0		161	80	0	0	0	15	
252	0		161	80	0	0	0	15	
253	0		161	80	0	0	0	15	
254	0		161	80	0	0	0	15	
255	0		161	80	0	0	0	15	

Section Configuration

Section	Control	Poll	Req #	Fail Time	Algorithm Period	Description
1	None	60	1	300	240	
2	None	60	1	300	240	
3	None	60	1	300	240	
4	None	60	1	300	240	
5	None	60	1	300	240	
6	None	60	1	300	240	
7	None	60	1	300	240	
8	None	60	1	300	240	
9	None	60	1	300	240	
10	None	60	1	300	240	
11	None	60	1	300	240	
12	None	60	1	300	240	
13	None	60	1	300	240	
14	None	60	1	300	240	
15	None	60	1	300	240	
16	None	60	1	300	240	

User Program Info

Pgrm	Description
1	Stop Time
2	
3	
4	
5	
6	
7	
8	
9	
10	
11	
12	
13	
14	
15	
16	
17	
18	
19	
20	
21	
22	
23	
24	
25	
26	
27	
28	
29	
30	
31	
32	

Colo Dept of Trans.

MaxTime Timing Shee

2.0.14

Administration

Unit Information

Controller ID	0
Main St.	SH 86
Side St.	Allen Pkwy

Adapter	IP Address	Subnet Mask	Default Gateway	ARP	DHCP
1	10.11.79.126	255.255.255.0	10.11.79.1	Disable	
2	10.20.70.51	255.255.255.0	0.0.0.0	Disable	

Serial Ports:

Port	Description	Function	Address	Baud	Bits	Stop	Parity	Flow	CTS	RTS
1	Port 2/C21S	None	1	9600	8	1	None	None	0	0
2	Aux_P3/C22S	None	1	9600	8	1	None	None	0	0
3	SDLC Port 1	None	1	9600	8	1	None	None	0	0
4	Com A/C50S	None	1	9600	8	1	None	None	0	0
5	FIO	None	1	9600	8	1	None	None	0	0
6	DISPLAY/C60M	None	1	9600	8	1	None	None	0	0
7	SP7	None	1	9600	8	1	None	None	0	0
8	SP8/Com B	None	1	9600	8	1	None	None	0	0

Unit Parameters

Startup Flash	0	Auto Ped Clr	Enable	Red Revert	4.0	Backup Time	600	Ext Mode	Disable
All Red Exit	6	Grn Flash Freq.	60	Yel Flash Freq.	60	MCE Enable	Enable	Free Seq.	1
MCE Seq.	1	Start Yellow	0.0	Start Red	0.0	Start Clear Hold	6		

Phase Parameters

Phases	1	2	3	4	5	6	7	8	9	10	11	12	13	14	15	16	17	18	19	20
Walk Time	0	7	0	7	0	7	0	7	0	0	0	0	0	0	0	0	0	0	0	0
Clear Time	0	15	0	32	0	28	0	33	0	0	0	0	0	0	0	0	0	0	0	0
Don't Walk	0	0	0	0	0	0	0	0	0	0	0	0	0	0	0	0	0	0	0	0
Min Green	5	20	5	5	5	20	5	5	1	1	1	1	1	1	1	1	1	1	1	1
Min Green 2	0	0	0	0	0	0	0	0	0	0	0	0	0	0	0	0	0	0	0	0
Passage	3.0	5.0	2.0	2.0	3.0	5.0	2.0	2.5	0.0	0.0	0.0	0.0	0.0	0.0	0.0	0.0	0.0	0.0	0.0	0.0
Max-1	15	80	20	10	20	80	20	20	0	0	0	0	0	0	0	0	0	0	0	0
Max-2	15	30	15	10	15	30	15	15	0	0	0	0	0	0	0	0	0	0	0	0
Max-3	0	0	0	0	0	0	0	0	0	0	0	0	0	0	0	0	0	0	0	0
Yel Change	3.0	4.0	3.0	4.0	3.0	4.0	3.0	4.0	3.0	3.0	3.0	3.0	3.0	3.0	3.0	3.0	3.0	3.0	3.0	3.0
Red Clear	2.0	2.0	2.0	2.0	2.0	2.0	2.0	2.0	0.0	0.0	0.0	0.0	0.0	0.0	0.0	0.0	0.0	0.0	0.0	0.0
Add Red Clear	0	0	0	0	0	0	0	0	0	0	0	0	0	0	0	0	0	0	0	0
Red Revert	0.0	0.0	0.0	0.0	0.0	0.0	0.0	0.0	0.0	0.0	0.0	0.0	0.0	0.0	0.0	0.0	0.0	0.0	0.0	0.0
Added Initial	0.0	0.0	0.0	0.0	0.0	0.0	0.0	0.0	0.0	0.0	0.0	0.0	0.0	0.0	0.0	0.0	0.0	0.0	0.0	0.0
Max Initial	0.0	0.0	0.0	0.0	0.0	0.0	0.0	0.0	0.0	0.0	0.0	0.0	0.0	0.0	0.0	0.0	0.0	0.0	0.0	0.0
Time B4 Reduce	0	0	0	0	0	0	0	0	0	0	0	0	0	0	0	0	0	0	0	0
Cars B4 Reduce	0	0	0	0	0	0	0	0	0	0	0	0	0	0	0	0	0	0	0	0
Time To Reduce	0	0	0	0	0	0	0	0	0	0	0	0	0	0	0	0	0	0	0	0
Reduce By	0.0	0.0	0.0	0.0	0.0	0.0	0.0	0.0	0.0	0.0	0.0	0.0	0.0	0.0	0.0	0.0	0.0	0.0	0.0	0.0
Min Gap	0.0	0.0	0.0	0.0	0.0	0.0	0.0	0.0	0.0	0.0	0.0	0.0	0.0	0.0	0.0	0.0	0.0	0.0	0.0	0.0
Dyn Max Limit	0	0	0	0	0	0	0	0	0	0	0	0	0	0	0	0	0	0	0	0
Dyn Max Step	0.0	0.0	0.0	0.0	0.0	0.0	0.0	0.0	0.0	0.0	0.0	0.0	0.0	0.0	0.0	0.0	0.0	0.0	0.0	0.0
Advance Walk	0	0	0	0	0	0	0	0	0	0	0	0	0	0	0	0	0	0	0	0
Delay Ped	0	0	0	0	0	0	0	0	0	0	0	0	0	0	0	0	0	0	0	0
Alt Walk	0	0	0	0	0	0	0	0	0	0	0	0	0	0	0	0	0	0	0	0
Alt Ped Clr																				
Pre Green	0.0	0.0	0.0	0.0	0.0	0.0	0.0	0.0	0.0	0.0	0.0	0.0	0.0	0.0	0.0	0.0	0.0	0.0	0.0	0.0
Pre Clearance	0.0	0.0	0.0	0.0	0.0	0.0	0.0	0.0	0.0	0.0	0.0	0.0	0.0	0.0	0.0	0.0	0.0	0.0	0.0	0.0

Phases	21	22	23	24	25	26	27	28	29	30	31	32	33	34	35	36	37	38	39	40
Walk Time	0	0	0	0	0	0	0	0	0	0	0	0	0	0	0	0	0	0	0	0
Clear Time	0	0	0	0	0	0	0	0	0	0	0	0	0	0	0	0	0	0	0	0
Don't Walk	0	0	0	0	0	0	0	0	0	0	0	0	0	0	0	0	0	0	0	0
Min Green	1	1	1	1	1	1	1	1	1	1	1	1	1	1	1	1	1	1	1	1

Min Green 2	0	0	0	0	0	0	0	0	0	0	0	0	0	0	0	0	0	0	0
Passage	0.0	0.0	0.0	0.0	0.0	0.0	0.0	0.0	0.0	0.0	0.0	0.0	0.0	0.0	0.0	0.0	0.0	0.0	0.0
Max-1	0	0	0	0	0	0	0	0	0	0	0	0	0	0	0	0	0	0	0
Max-2	0	0	0	0	0	0	0	0	0	0	0	0	0	0	0	0	0	0	0
Max-3	0	0	0	0	0	0	0	0	0	0	0	0	0	0	0	0	0	0	0
Yel Change	3.0	3.0	3.0	3.0	3.0	3.0	3.0	3.0	3.0	3.0	3.0	3.0	3.0	3.0	3.0	3.0	3.0	3.0	3.0
Red Clear	0.0	0.0	0.0	0.0	0.0	0.0	0.0	0.0	0.0	0.0	0.0	0.0	0.0	0.0	0.0	0.0	0.0	0.0	0.0
Add Red Clear	0	0	0	0	0	0	0	0	0	0	0	0	0	0	0	0	0	0	0
Red Revert	0.0	0.0	0.0	0.0	0.0	0.0	0.0	0.0	0.0	0.0	0.0	0.0	0.0	0.0	0.0	0.0	0.0	0.0	0.0
Added Initial	0.0	0.0	0.0	0.0	0.0	0.0	0.0	0.0	0.0	0.0	0.0	0.0	0.0	0.0	0.0	0.0	0.0	0.0	0.0
Max Initial	0.0	0.0	0.0	0.0	0.0	0.0	0.0	0.0	0.0	0.0	0.0	0.0	0.0	0.0	0.0	0.0	0.0	0.0	0.0
Time B4 Reduce	0	0	0	0	0	0	0	0	0	0	0	0	0	0	0	0	0	0	0
Cars B4 Reduce	0	0	0	0	0	0	0	0	0	0	0	0	0	0	0	0	0	0	0
Time To Reduce	0	0	0	0	0	0	0	0	0	0	0	0	0	0	0	0	0	0	0
Reduce By	0.0	0.0	0.0	0.0	0.0	0.0	0.0	0.0	0.0	0.0	0.0	0.0	0.0	0.0	0.0	0.0	0.0	0.0	0.0
Min Gap	0.0	0.0	0.0	0.0	0.0	0.0	0.0	0.0	0.0	0.0	0.0	0.0	0.0	0.0	0.0	0.0	0.0	0.0	0.0
Dyn Max Limit	0	0	0	0	0	0	0	0	0	0	0	0	0	0	0	0	0	0	0
Dyn Max Step	0.0	0.0	0.0	0.0	0.0	0.0	0.0	0.0	0.0	0.0	0.0	0.0	0.0	0.0	0.0	0.0	0.0	0.0	0.0
Advance Walk	0	0	0	0	0	0	0	0	0	0	0	0	0	0	0	0	0	0	0
Delay Ped	0	0	0	0	0	0	0	0	0	0	0	0	0	0	0	0	0	0	0
Alt Walk	0	0	0	0	0	0	0	0	0	0	0	0	0	0	0	0	0	0	0
Alt Ped Cir																			
Pre Green	0.0	0.0	0.0	0.0	0.0	0.0	0.0	0.0	0.0	0.0	0.0	0.0	0.0	0.0	0.0	0.0	0.0	0.0	0.0
Pre Clearance	0.0	0.0	0.0	0.0	0.0	0.0	0.0	0.0	0.0	0.0	0.0	0.0	0.0	0.0	0.0	0.0	0.0	0.0	0.0

Phase Options

Phases	1	2	3	4	5	6	7	8	9	10	11	12	13	14	15	16	17	18	19	20
Enable	X	X	X	X	X	X	X	X												
Auto Flash Ent.		X				X														
Auto Flash Exit		X				X														
Non Actuated I																				
Non Actuated II																				
Non Lock Mem	X	X	X	X	X	X	X	X												
Min Veh Recall		X				X														
Max Veh Recall																				
Ped Recall																				
Soft Veh Recall																				
Dual Entry																				
Sim Gap Dis																				
Guaranteed Pass																				
Act Rest Walk																				
Cond Service																				
Add Initial																				

Phases	21	22	23	24	25	26	27	28	29	30	31	32	33	34	35	36	37	38	39	40
Enable																				
Auto Flash Ent.																				
Auto Flash Exit																				
Non Actuated I																				
Non Actuated II																				
Non Lock Mem																				
Min Veh Recall																				
Max Veh Recall																				
Ped Recall																				
Soft Veh Recall																				
Dual Entry																				
Sim Gap Dis																				
Guaranteed Pass																				
Act Rest Walk																				
Cond Service																				
Add Initial																				

Additional Phase Options

--	--	--	--	--	--	--	--	--	--	--	--	--	--	--	--	--	--	--	--	--

Phases	1	2	3	4	5	6	7	8	9	10	11	12	13	14	15	16	17	18	19	20
Ped Clr During Yel																				
Ped Clr During Red																				
Cond Reservice																				
Yel Min Override																				
No Startup Call																				
Adv. Warn Flasher																				
No Ped Str Up Call																				
Ped Clr OVTG																				
Flash Exit Call																				
Flash Exit Ped Call																				
MinGreen2																				
MaxGreen2																				
MaxGreen3																				
Ped2																				
Ped Clear Pre Clear																				
Ped NA+ Mode																				
Red Rest																				
Serve Evy Oth Even																				
Serve Evy Oth Odd																				

Phases	21	22	23	24	25	26	27	28	29	30	31	32	33	34	35	36	37	38	39	40
Ped Clr During Yel																				
Ped Clr During Red																				
Cond Reservice																				
Yel Min Override																				
No Startup Call																				
Adv. Warn Flasher																				
No Ped Str Up Call																				
Ped Clr OVTG																				
Flash Exit Call																				
Flash Exit Ped Call																				
MinGreen2																				
MaxGreen2																				
MaxGreen3																				
Ped2																				
Ped Clear Pre Clear																				
Ped NA+ Mode																				
Red Rest																				
Serve Evy Oth Even																				
Serve Evy Oth Odd																				

Phase Configuration

Ph.	Startup	Ring	Concurrent	No Served Phases	Startup Min	Description
1	Phase Not On	1	5,6		0	
2	Green No Walk	1	5,6		0	
3	Phase Not On	1	7,8		0	
4	Phase Not On	1	7,8		0	
5	Phase Not On	2	1,2		0	
6	Green No Walk	2	1,2		0	
7	Phase Not On	2	3,4		0	
8	Phase Not On	2	3,4		0	
9	None	0			0	
10	None	0			0	
11	None	0			0	
12	None	0			0	
13	None	0			0	
14	None	0			0	
15	None	0			0	
16	None	0			0	
17	None	0			0	
18	None	0			0	
19	None	0			0	
20	None	0			0	

21	None	0			0
22	None	0			0
23	None	0			0
24	None	0			0
25	None	0			0
26	None	0			0
27	None	0			0
28	None	0			0
29	None	0			0
30	None	0			0
31	None	0			0
32	None	0			0
33	None	0			0
34	None	0			0
35	None	0			0
36	None	0			0
37	None	0			0
38	None	0			0
39	None	0			0
40	None	0			0

Sequence Configuration

Sequence 1

Ring	Phases
1	1,2,a,3,4,b
2	5,6,a,7,8,b
3	
4	
5	
6	
7	
8	
9	
10	
11	
12	
13	
14	
15	
16	

Sequence 2

Ring	Phases
1	1,2,a,3,4,b
2	5,6,a,7,8,b
3	
4	
5	
6	
7	
8	
9	
10	
11	
12	
13	
14	
15	
16	

Sequence 3

Ring	Phases
1	1,2,a,3,4,b
2	5,6,a,7,8,b
3	
4	
5	
6	
7	
8	
9	
10	
11	
12	
13	
14	
15	
16	

Sequence 4

Ring	Phases
1	1,2,a,3,4,b
2	5,6,a,7,8,b
3	
4	
5	
6	
7	
8	
9	
10	
11	
12	
13	
14	
15	
16	

Sequence 5

Ring	Phases
1	1,2,a,3,4,b
2	6,5,a,7,8,b
3	
4	
5	
6	
7	
8	
9	
10	
11	
12	
13	
14	
15	
16	

Sequence 6

Ring	Phases
1	2,1,a,3,4,b
2	6,5,a,7,8,b
3	
4	
5	
6	
7	
8	
9	
10	
11	
12	
13	
14	
15	
16	

Sequence 7

Ring	Phases
1	1,2,a,4,3,b
2	6,5,a,7,8,b
3	
4	
5	
6	
7	
8	
9	
10	
11	
12	
13	
14	
15	
16	

Sequence 8

Ring	Phases
1	2,1,a,4,3,b
2	6,5,a,7,8,b
3	
4	
5	
6	
7	
8	
9	
10	
11	
12	
13	
14	
15	
16	

Sequence 9

Ring	Phases
1	1,2,a,3,4,b

Sequence 10

Ring	Phases
1	2,1,a,3,4,b

Sequence 11

Ring	Phases
1	1,2,a,4,3,b

Sequence 12

Ring	Phases
1	2,1,a,4,3,b

2	5,6,a,8,7,b	2	5,6,a,8,7,b	2	5,6,a,8,7,b	2	5,6,a,8,7,b
3		3		3		3	
4		4		4		4	
5		5		5		5	
6		6		6		6	
7		7		7		7	
8		8		8		8	
9		9		9		9	
10		10		10		10	
11		11		11		11	
12		12		12		12	
13		13		13		13	
14		14		14		14	
15		15		15		15	
16		16		16		16	

Sequence 13

Ring	Phases
1	1,2,a,3,4,b
2	6,5,a,8,7,b
3	
4	
5	
6	
7	
8	
9	
10	

Sequence 14

Ring	Phases
1	2,1,a,3,4,b
2	6,5,a,8,7,b
3	
4	
5	
6	
7	
8	
9	
10	

Sequence 15

Ring	Phases
1	1,2,a,4,3,b
2	6,5,a,8,7,b
3	
4	
5	
6	
7	
8	
9	
10	

Sequence 16

Ring	Phases
1	2,1,a,4,3,b
2	6,5,a,8,7,b
3	
4	
5	
6	
7	
8	
9	
10	

Sequence 13

11	
12	
13	
14	
15	
16	

Sequence 14

11	
12	
13	
14	
15	
16	

Sequence 15

11	
12	
13	
14	
15	
16	

Sequence 16

11	
12	
13	
14	
15	
16	

Sequence 17

Ring	Phases
1	
2	
3	
4	
5	
6	
7	
8	
9	
10	
11	
12	
13	
14	
15	
16	

Sequence 18

Ring	Phases
1	
2	
3	
4	
5	
6	
7	
8	
9	
10	
11	
12	
13	
14	
15	
16	

Sequence 19

Ring	Phases
1	
2	
3	
4	
5	
6	
7	
8	
9	
10	
11	
12	
13	
14	
15	
16	

Sequence 20

Ring	Phases
1	1,2,a,3,4,b
2	5,6,a,7,8,b
3	
4	
5	
6	
7	
8	
9	
10	
11	
12	
13	
14	
15	
16	

Vehicle Detection Parameters

Det.	Call Phs	Call Ovl	Additional Call Phase	Switch Phase	Delay	Extend	Queue Limit	No Activity	Max Presence	Erratic Counts	Failed Time	Description
1	1	0		0	0.0	0.0	0	0	0	0	0	
2	2	0		0	0.0	0.0	0	0	0	0	0	
3	2	0		0	0.0	0.0	0	0	0	0	0	
4	2	0		0	0.0	0.0	0	0	0	0	0	
5	2	0		0	0.0	0.0	0	0	0	0	0	

6	2	0		0	0.0	0.0	0	0	0	0	0	
7	3	0		0	0.0	0.0	0	0	0	0	0	
8	4	0		0	0.0	0.0	0	0	0	0	0	
9	4	0		0	0.0	0.0	0	0	0	0	0	
10	4	0		0	0.0	0.0	0	0	0	0	0	
11	4	0		0	0.0	0.0	0	0	0	0	0	
12	4	0		0	0.0	0.0	0	0	0	0	0	
13	1	0		0	0.0	0.0	0	0	0	0	0	
14	3	0		0	0.0	0.0	0	0	0	0	0	
15	5	0		0	0.0	0.0	0	0	0	0	0	
16	6	0		0	0.0	0.0	0	0	0	0	0	
17	6	0		0	0.0	0.0	0	0	0	0	0	
18	6	0		0	0.0	0.0	0	0	0	0	0	
19	6	0		0	0.0	0.0	0	0	0	0	0	
20	6	0		0	0.0	0.0	0	0	0	0	0	
21	7	0		0	0.0	0.0	0	0	0	0	0	
22	8	0		0	0.0	0.0	0	0	0	0	0	
23	8	0		0	0.0	0.0	0	0	0	0	0	
24	8	0		0	0.0	0.0	0	0	0	0	0	
25	8	0		0	0.0	0.0	0	0	0	0	0	
26	8	0		0	0.0	0.0	0	0	0	0	0	
27	5	0		0	0.0	0.0	0	0	0	0	0	
28	7	0		0	0.0	0.0	0	0	0	0	0	
29	0	0		0	0.0	0.0	0	0	0	0	0	
30	0	0		0	0.0	0.0	0	0	0	0	0	
31	0	0		0	0.0	0.0	0	0	0	0	0	
32	0	0		0	0.0	0.0	0	0	0	0	0	
33	0	0		0	0.0	0.0	0	0	0	0	0	
34	0	0		0	0.0	0.0	0	0	0	0	0	
35	0	0		0	0.0	0.0	0	0	0	0	0	
36	0	0		0	0.0	0.0	0	0	0	0	0	
37	0	0		0	0.0	0.0	0	0	0	0	0	
38	0	0		0	0.0	0.0	0	0	0	0	0	
39	0	0		0	0.0	0.0	0	0	0	0	0	
40	0	0		0	0.0	0.0	0	0	0	0	0	
41	0	0		0	0.0	0.0	0	0	0	0	0	
42	0	0		0	0.0	0.0	0	0	0	0	0	
43	0	0		0	0.0	0.0	0	0	0	0	0	
44	0	0		0	0.0	0.0	0	0	0	0	0	
45	0	0		0	0.0	0.0	0	0	0	0	0	
46	0	0		0	0.0	0.0	0	0	0	0	0	
47	0	0		0	0.0	0.0	0	0	0	0	0	
48	0	0		0	0.0	0.0	0	0	0	0	0	
49	0	0		0	0.0	0.0	0	0	0	0	0	
50	0	0		0	0.0	0.0	0	0	0	0	0	
51	0	0		0	0.0	0.0	0	0	0	0	0	
52	0	0		0	0.0	0.0	0	0	0	0	0	
53	0	0		0	0.0	0.0	0	0	0	0	0	
54	0	0		0	0.0	0.0	0	0	0	0	0	
55	0	0		0	0.0	0.0	0	0	0	0	0	
56	0	0		0	0.0	0.0	0	0	0	0	0	
57	0	0		0	0.0	0.0	0	0	0	0	0	
58	0	0		0	0.0	0.0	0	0	0	0	0	
59	0	0		0	0.0	0.0	0	0	0	0	0	
60	0	0		0	0.0	0.0	0	0	0	0	0	
61	0	0		0	0.0	0.0	0	0	0	0	0	
62	0	0		0	0.0	0.0	0	0	0	0	0	
63	0	0		0	0.0	0.0	0	0	0	0	0	
64	0	0		0	0.0	0.0	0	0	0	0	0	
65	0	0		0	0.0	0.0	0	0	0	0	0	
66	0	0		0	0.0	0.0	0	0	0	0	0	
67	0	0		0	0.0	0.0	0	0	0	0	0	
68	0	0		0	0.0	0.0	0	0	0	0	0	

69	0	0		0	0.0	0.0	0	0	0	0	0	
70	0	0		0	0.0	0.0	0	0	0	0	0	
71	0	0		0	0.0	0.0	0	0	0	0	0	
72	0	0		0	0.0	0.0	0	0	0	0	0	

Vehicle Detection Options

Detector	1	2	3	4	5	6	7	8	9	10	11	12	13	14	15	16	17	18	19	20
Volume Detector	X	X	X	X	X	X	X	X	X	X	X	X	X	X	X	X	X	X	X	X
Occupancy	X	X	X	X	X	X	X	X	X	X	X	X	X	X	X	X	X	X	X	X
Yellow Lock Call																				
Red Lock call																				
Passage	X	X	X	X	X	X	X	X	X	X	X	X	X	X	X	X	X	X	X	X
Queue																				
Call	X	X	X	X	X	X	X	X	X	X	X	X	X	X	X	X	X	X	X	X
Terminate																				

Detector	21	22	23	24	25	26	27	28	29	30	31	32	33	34	35	36	37	38	39	40
Volume Detector	X	X	X	X	X	X	X	X	X	X	X	X	X	X	X	X	X	X	X	X
Occupancy	X	X	X	X	X	X	X	X	X	X	X	X	X	X	X	X	X	X	X	X
Yellow Lock Call																				
Red Lock call			X																	
Passage	X	X	X	X	X	X	X	X												
Queue																				
Call	X	X	X	X	X	X	X	X												
Terminate																				

Detector	41	42	43	44	45	46	47	48	49	50	51	52	53	54	55	56	57	58	59	60
Volume Detector	X	X	X	X	X	X	X	X	X	X	X	X	X	X	X	X	X	X	X	X
Occupancy	X	X	X	X	X	X	X	X	X	X	X	X	X	X	X	X	X	X	X	X
Yellow Lock Call																				
Red Lock call			X																	
Passage																				
Queue																				
Call																				
Terminate																				

Detector	61	62	63	64	65	66	67	68	69	70	71	72
Volume Detector	X	X	X	X	X	X	X	X	X	X	X	X
Occupancy	X	X	X	X	X	X	X	X	X	X	X	X
Yellow Lock Call												
Red Lock call												
Passage												
Queue												
Call												
Terminate												

Data Collection Period	0
------------------------	---

Pedestrian Detectors

Det	Call Phase	Call Ovp	No Act	Max Presence	Erratic Count
1	0	0	0	0	0
2	2	0	0	0	0
3	0	0	0	0	0
4	4	0	0	0	0
5	0	0	0	0	0
6	6	0	0	0	0
7	0	0	0	0	0
8	8	0	0	0	0
9	0	0	0	0	0
10	0	0	0	0	0
11	0	0	0	0	0
12	0	0	0	0	0
13	0	0	0	0	0
14	0	0	0	0	0
15	0	0	0	0	0

Det	Call Phase	Call Ovp	No Act	Max Presence	Erratic Count
21	0	0	0	0	0
22	0	0	0	0	0
23	0	0	0	0	0
24	0	0	0	0	0
25	0	0	0	0	0
26	0	0	0	0	0
27	0	0	0	0	0
28	0	0	0	0	0
29	0	0	0	0	0
30	0	0	0	0	0
31	0	0	0	0	0
32	0	0	0	0	0
33	0	0	0	0	0
34	0	0	0	0	0
35	0	0	0	0	0

16	0	0	0	0	0
17	0	0	0	0	0
18	0	0	0	0	0
19	0	0	0	0	0
20	0	0	0	0	0

36	0	0	0	0	0
37	0	0	0	0	0
38	0	0	0	0	0
39	0	0	0	0	0
40	0	0	0	0	0

Overlaps

OLP	Type	Included Phases	Modifier Phases	Trail		Walk		Ped		Delay	Flash	Descriptions
				GRN	YEL	1	2	Clr 1	Clr 2			
1	Off			0	0.0	0.0	0	0	0	0.0	Off	
2	Off			0	0.0	0.0	0	0	0	0.0	Off	
3	FYA - 4 Sec	4	3	0	0.0	0.0	0	0	0	0.0	Off	
4	Thur FYA Ped	4		0	0.0	0.0	0	0	0	0.0	Off	
5	Off			0	0.0	0.0	0	0	0	0.0	Off	
6	Off			0	0.0	0.0	0	0	0	0.0	Off	
7	FYA - 4 Sec	8	7	0	0.0	0.0	0	0	0	0.0	Off	
8	Thur FYA Ped	8		0	0.0	0.0	0	0	0	0.0	Off	
9	Off			0	0.0	0.0	0	0	0	0.0	Off	
10	Off			0	0.0	0.0	0	0	0	0.0	Off	
11	Off			0	0.0	0.0	0	0	0	0.0	Off	
12	Off			0	0.0	0.0	0	0	0	0.0	Off	
13	Off			0	0.0	0.0	0	0	0	0.0	Off	
14	Off			0	0.0	0.0	0	0	0	0.0	Off	
15	Off			0	0.0	0.0	0	0	0	0.0	Off	
16	Off			0	0.0	0.0	0	0	0	0.0	Off	
17	Off			0	0.0	0.0	0	0	0	0.0	Off	
18	Off			0	0.0	0.0	0	0	0	0.0	Off	
19	Off			0	0.0	0.0	0	0	0	0.0	Off	
20	Off			0	0.0	0.0	0	0	0	0.0	Off	
21	Off			0	0.0	0.0	0	0	0	0.0	Off	
22	Off			0	0.0	0.0	0	0	0	0.0	Off	
23	Off			0	0.0	0.0	0	0	0	0.0	Off	
24	Off			0	0.0	0.0	0	0	0	0.0	Off	
25	Off			0	0.0	0.0	0	0	0	0.0	Off	
26	Off			0	0.0	0.0	0	0	0	0.0	Off	
27	Off			0	0.0	0.0	0	0	0	0.0	Off	
28	Off			0	0.0	0.0	0	0	0	0.0	Off	
29	Off			0	0.0	0.0	0	0	0	0.0	Off	
30	Off			0	0.0	0.0	0	0	0	0.0	Off	
31	Off			0	0.0	0.0	0	0	0	0.0	Off	
32	Off			0	0.0	0.0	0	0	0	0.0	Off	

Coordination Parameters

Operational Mode	Correction Mode	Maximum Mode	Force Mode
Automatic	Shortway (Auto)	Max Inhibit	Floating

Patterns

Patt.	Cycle	Offset 1	Offset 2	Offset 2	Split	Sequence	Ref. Color	Max Mode	Phs	Det	Ped
									Pln	Pln	Pln
1	120	36	0	0	1	1	Yel	Inh	1	1	1
2	90	60	0	0	2	2	Yel	Inh	1	1	1
3	120	107	0	0	3	3	Yel	Inh	1	1	1
4	100	70	0	0	4	4	Yel	Inh	1	1	1
5	0	0	0	0	0	0	Yel	Inh	1	1	1
6	0	0	0	0	0	0	Yel	Inh	1	1	1
7	0	0	0	0	0	0	Yel	Inh	1	1	1
8	0	0	0	0	0	0	Yel	Inh	1	1	1
9	0	0	0	0	0	0	Yel	Inh	1	1	1
10	0	0	0	0	0	0	Yel	Inh	1	1	1
11	0	0	0	0	0	0	Yel	Inh	1	1	1
12	0	0	0	0	0	0	Yel	Inh	1	1	1
13	0	0	0	0	0	0	Yel	Inh	1	1	1
14	0	0	0	0	0	0	Yel	Inh	1	1	1
15	0	0	0	0	0	0	Yel	Inh	1	1	1
16	0	0	0	0	0	0	Yel	Inh	1	1	1
17	0	0	0	0	0	0	Yel	Inh	1	1	1

18	0	0	0	0	0	0	Yel	Inh	1	1	1
19	0	0	0	0	0	0	Yel	Inh	1	1	1
20	0	0	0	0	20	20	Yel	Max2	1	1	1
21	0	0	0	0	0	0	Yel	Inh	1	1	1
22	0	0	0	0	0	0	Yel	Inh	1	1	1
23	0	0	0	0	0	0	Yel	Inh	1	1	1
24	0	0	0	0	0	0	Yel	Inh	1	1	1
25	0	0	0	0	0	0	Yel	Inh	1	1	1
26	0	0	0	0	0	0	Yel	Inh	1	1	1
27	0	0	0	0	0	0	Yel	Inh	1	1	1
28	0	0	0	0	0	0	Yel	Inh	1	1	1
29	0	0	0	0	0	0	Yel	Inh	1	1	1
30	0	0	0	0	0	0	Yel	Inh	1	1	1
31	0	0	0	0	0	0	Yel	Inh	1	1	1
32	0	0	0	0	0	0	Yel	Inh	1	1	1
33	0	0	0	0	0	0	Yel	Inh	1	1	1
34	0	0	0	0	0	0	Yel	Inh	1	1	1
35	0	0	0	0	0	0	Yel	Inh	1	1	1
36	0	0	0	0	0	0	Yel	Inh	1	1	1
37	0	0	0	0	0	0	Yel	Inh	1	1	1
38	0	0	0	0	0	0	Yel	Inh	1	1	1
39	0	0	0	0	0	0	Yel	Inh	1	1	1
40	0	0	0	0	0	0	Yel	Inh	1	1	1
41	0	0	0	0	0	0	Yel	Inh	1	1	1
42	0	0	0	0	0	0	Yel	Inh	1	1	1
43	0	0	0	0	0	0	Yel	Inh	1	1	1
44	0	0	0	0	0	0	Yel	Inh	1	1	1
45	0	0	0	0	0	0	Yel	Inh	1	1	1
46	0	0	0	0	0	0	Yel	Inh	1	1	1
47	0	0	0	0	0	0	Yel	Inh	1	1	1
48	0	0	0	0	0	0	Yel	Inh	1	1	1
49	0	0	0	0	0	0	Yel	Inh	1	1	1
50	0	0	0	0	0	0	Yel	Inh	1	1	1
51	0	0	0	0	0	0	Yel	Inh	1	1	1
52	0	0	0	0	0	0	Yel	Inh	1	1	1
53	0	0	0	0	0	0	Yel	Inh	1	1	1
54	0	0	0	0	0	0	Yel	Inh	1	1	1
55	0	0	0	0	0	0	Yel	Inh	1	1	1
56	0	0	0	0	0	0	Yel	Inh	1	1	1
57	0	0	0	0	0	0	Yel	Inh	1	1	1
58	0	0	0	0	0	0	Yel	Inh	1	1	1
59	0	0	0	0	0	0	Yel	Inh	1	1	1
60	0	0	0	0	0	0	Yel	Inh	1	1	1
61	0	0	0	0	0	0	Yel	Inh	1	1	1
62	0	0	0	0	0	0	Yel	Inh	1	1	1
63	0	0	0	0	0	0	Yel	Inh	1	1	1
64	0	0	0	0	0	0	Yel	Inh	1	1	1
65	0	0	0	0	0	0	Yel	Inh	1	1	1
66	0	0	0	0	0	0	Yel	Inh	1	1	1
67	0	0	0	0	0	0	Yel	Inh	1	1	1
68	0	0	0	0	0	0	Yel	Inh	1	1	1
69	0	0	0	0	0	0	Yel	Inh	1	1	1
70	0	0	0	0	0	0	Yel	Inh	1	1	1
71	0	0	0	0	0	0	Yel	Inh	1	1	1
72	0	0	0	0	0	0	Yel	Inh	1	1	1
73	0	0	0	0	0	0	Yel	Inh	1	1	1
74	0	0	0	0	0	0	Yel	Inh	1	1	1
75	0	0	0	0	0	0	Yel	Inh	1	1	1
76	0	0	0	0	0	0	Yel	Inh	1	1	1
77	0	0	0	0	0	0	Yel	Inh	1	1	1
78	0	0	0	0	0	0	Yel	Inh	1	1	1
79	0	0	0	0	0	0	Yel	Inh	1	1	1
80	0	0	0	0	0	0	Yel	Inh	1	1	1

81	0	0	0	0	0	0	Yel	Inh	1	1	1
82	0	0	0	0	0	0	Yel	Inh	1	1	1
83	0	0	0	0	0	0	Yel	Inh	1	1	1
84	0	0	0	0	0	0	Yel	Inh	1	1	1
85	0	0	0	0	0	0	Yel	Inh	1	1	1
86	0	0	0	0	0	0	Yel	Inh	1	1	1
87	0	0	0	0	0	0	Yel	Inh	1	1	1
88	0	0	0	0	0	0	Yel	Inh	1	1	1
89	0	0	0	0	0	0	Yel	Inh	1	1	1
90	0	0	0	0	0	0	Yel	Inh	1	1	1
91	0	0	0	0	0	0	Yel	Inh	1	1	1
92	0	0	0	0	0	0	Yel	Inh	1	1	1
93	0	0	0	0	0	0	Yel	Inh	1	1	1
94	0	0	0	0	0	0	Yel	Inh	1	1	1
95	0	0	0	0	0	0	Yel	Inh	1	1	1
96	0	0	0	0	0	0	Yel	Inh	1	1	1
97	0	0	0	0	0	0	Yel	Inh	1	1	1
98	0	0	0	0	0	0	Yel	Inh	1	1	1
99	0	0	0	0	0	0	Yel	Inh	1	1	1
100	0	0	0	0	0	0	Yel	Inh	1	1	1
101	0	0	0	0	0	0	Yel	Inh	1	1	1
102	0	0	0	0	0	0	Yel	Inh	1	1	1
103	0	0	0	0	0	0	Yel	Inh	1	1	1
104	0	0	0	0	0	0	Yel	Inh	1	1	1
105	0	0	0	0	0	0	Yel	Inh	1	1	1
106	0	0	0	0	0	0	Yel	Inh	1	1	1
107	0	0	0	0	0	0	Yel	Inh	1	1	1
108	0	0	0	0	0	0	Yel	Inh	1	1	1
109	0	0	0	0	0	0	Yel	Inh	1	1	1
110	0	0	0	0	0	0	Yel	Inh	1	1	1
111	0	0	0	0	0	0	Yel	Inh	1	1	1
112	0	0	0	0	0	0	Yel	Inh	1	1	1
113	0	0	0	0	0	0	Yel	Inh	1	1	1
114	0	0	0	0	0	0	Yel	Inh	1	1	1
115	0	0	0	0	0	0	Yel	Inh	1	1	1
116	0	0	0	0	0	0	Yel	Inh	1	1	1
117	0	0	0	0	0	0	Yel	Inh	1	1	1
118	0	0	0	0	0	0	Yel	Inh	1	1	1
119	0	0	0	0	0	0	Yel	Inh	1	1	1
120	0	0	0	0	0	0	Yel	Inh	1	1	1
121	0	0	0	0	0	0	Yel	Inh	1	1	1
122	0	0	0	0	0	0	Yel	Inh	1	1	1
123	0	0	0	0	0	0	Yel	Inh	1	1	1
124	0	0	0	0	0	0	Yel	Inh	1	1	1
125	0	0	0	0	0	0	Yel	Inh	1	1	1
126	0	0	0	0	0	0	Yel	Inh	1	1	1
127	0	0	0	0	0	0	Yel	Inh	1	1	1
128	0	0	0	0	0	0	Yel	Inh	1	1	1

Split Parameters

Split 1		Coord	Ref	Mode
PH.	Time	PH	PH	
1	11			None
2	83	X	X	None
3	14			None
4	12			None
5	15			None
6	79	X	X	None
7	13			None
8	13			None
9	0			None
10	0			None
11	0			None
12	0			None

Split 2		Coord	Ref	Mode
PH.	Time	PH	PH	
1	10			None
2	50	X	X	None
3	17			None
4	13			None
5	17			None
6	43	X	X	None
7	17			None
8	13			None
9	0			None
10	0			None
11	0			None
12	0			None

13	0			None
14	0			None
15	0			None
16	0			None

13	0			None
14	0			None
15	0			None
16	0			None

Split 3		Coord	Ref	
PH.	Time	PH	PH	Mode
1	11			None
2	83	X	X	None
3	13			None
4	13			None
5	20			None
6	74	X	X	None
7	13			None
8	13			None
9	0			None
10	0			None
11	0			None
12	0			None
13	0			None
14	0			None
15	0			None
16	0			None

Split 4		Coord	Ref	
PH.	Time	PH	PH	Mode
1	11			None
2	58	X	X	None
3	18			None
4	13			None
5	20			None
6	49	X	X	None
7	18			None
8	13			None
9	0			None
10	0			None
11	0			None
12	0			None
13	0			None
14	0			None
15	0			None
16	0			None

Split 5		Coord	Ref	
PH.	Time	PH	PH	Mode
1	0			None
2	0			None
3	0			None
4	0			None
5	0			None
6	0			None
7	0			None
8	0			None
9	0			None
10	0			None
11	0			None
12	0			None
13	0			None
14	0			None
15	0			None
16	0			None

Split 6		Coord	Ref	
PH.	Time	PH	PH	Mode
1	0			None
2	0			None
3	0			None
4	0			None
5	0			None
6	0			None
7	0			None
8	0			None
9	0			None
10	0			None
11	0			None
12	0			None
13	0			None
14	0			None
15	0			None
16	0			None

Split 7		Coord	Ref	
PH.	Time	PH	PH	Mode
1	0			None
2	0			None
3	0			None
4	0			None
5	0			None
6	0			None
7	0			None
8	0			None
9	0			None
10	0			None
11	0			None
12	0			None
13	0			None
14	0			None
15	0			None
16	0			None

Split 8		Coord	Ref	
PH.	Time	PH	PH	Mode
1	0			None
2	0			None
3	0			None
4	0			None
5	0			None
6	0			None
7	0			None
8	0			None
9	0			None
10	0			None
11	0			None
12	0			None
13	0			None
14	0			None
15	0			None
16	0			None

Split 9		Coord	Ref	
---------	--	-------	-----	--

Split 10		Coord	Ref	
----------	--	-------	-----	--

PH.	Time	PH	PH	Mode
1	0			None
2	0			None
3	0			None
4	0			None
5	0			None
6	0			None
7	0			None
8	0			None
9	0			None

PH.	Time	PH	PH	Mode
1	0			None
2	0			None
3	0			None
4	0			None
5	0			None
6	0			None
7	0			None
8	0			None
9	0			None

Split 9

		Coord	Ref	
PH.	Time	PH	PH	Mode
10	0			None
11	0			None
12	0			None
13	0			None
14	0			None
15	0			None
16	0			None

Split 10

		Coord	Ref	
PH.	Time	PH	PH	Mode
10	0			None
11	0			None
12	0			None
13	0			None
14	0			None
15	0			None
16	0			None

Split 11

		Coord	Ref	
PH.	Time	PH	PH	Mode
1	0			None
2	0			None
3	0			None
4	0			None
5	0			None
6	0			None
7	0			None
8	0			None
9	0			None
10	0			None
11	0			None
12	0			None
13	0			None
14	0			None
15	0			None
16	0			None

Split 12

		Coord	Ref	
PH.	Time	PH	PH	Mode
1	0			None
2	0			None
3	0			None
4	0			None
5	0			None
6	0			None
7	0			None
8	0			None
9	0			None
10	0			None
11	0			None
12	0			None
13	0			None
14	0			None
15	0			None
16	0			None

Split 13

		Coord	Ref	
PH.	Time	PH	PH	Mode
1	0			None
2	0			None
3	0			None
4	0			None
5	0			None
6	0			None
7	0			None
8	0			None
9	0			None
10	0			None
11	0			None
12	0			None
13	0			None
14	0			None
15	0			None
16	0			None

Split 14

		Coord	Ref	
PH.	Time	PH	PH	Mode
1	0			None
2	0			None
3	0			None
4	0			None
5	0			None
6	0			None
7	0			None
8	0			None
9	0			None
10	0			None
11	0			None
12	0			None
13	0			None
14	0			None
15	0			None
16	0			None

Split 15

		Coord	Ref	
PH.	Time	PH	PH	Mode
1	0			None
2	0			None
3	0			None

Split 16

		Coord	Ref	
PH.	Time	PH	PH	Mode
1	0			None
2	0			None
3	0			None

4	0			None
5	0			None
6	0			None
7	0			None
8	0			None
9	0			None
10	0			None
11	0			None
12	0			None
13	0			None
14	0			None
15	0			None
16	0			None

4	0			None
5	0			None
6	0			None
7	0			None
8	0			None
9	0			None
10	0			None
11	0			None
12	0			None
13	0			None
14	0			None
15	0			None
16	0			None

Split 17

		Coord	Ref	
PH.	Time	PH	PH	Mode
1	0			None
2	0			None
3	0			None
4	0			None
5	0			None
6	0			None
7	0			None
8	0			None
9	0			None
10	0			None
11	0			None
12	0			None
13	0			None
14	0			None
15	0			None
16	0			None

Split 18

		Coord	Ref	
PH.	Time	PH	PH	Mode
1	0			None
2	0			None
3	0			None
4	0			None
5	0			None
6	0			None
7	0			None
8	0			None
9	0			None
10	0			None
11	0			None
12	0			None
13	0			None
14	0			None
15	0			None
16	0			None

Split 19

		Coord	Ref	
PH.	Time	PH	PH	Mode
1	0			None
2	0			None
3	0			None
4	0			None
5	0			None
6	0			None

Split 20

		Coord	Ref	
PH.	Time	PH	PH	Mode
1	0			None
2	0	X	X	None
3	0			None
4	0			None
5	0			None
6	0	X	X	None

Split 19

		Coord	Ref	
PH.	Time	PH	PH	Mode
7	0			None
8	0			None
9	0			None
10	0			None
11	0			None
12	0			None
13	0			None
14	0			None
15	0			None
16	0			None

Split 20

		Coord	Ref	
PH.	Time	PH	PH	Mode
7	0			None
8	0			None
9	0			None
10	0			None
11	0			None
12	0			None
13	0			None
14	0			None
15	0			None
16	0			None

Ring	1	2	3	4	5	6	7	8	9	10	11	12	13	14	15	16
Offset																

Day Plan 1

Month of Year		Days of Week					Days of Month																						
J	F	M	A	M	J	S	M	T	W	T	F	S	1	2	3	4	5	6	7	8	9	10	11	12	13	14	15	16	
X	X	X	X	X	X		X	X	X	X	X		X	X	X	X	X	X	X	X	X	X	X	X	X	X	X	X	X

J	A	S	O	N	D
X	X	X	X	X	X

17	18	19	20	21	22	23	24	25	26	27	28	29	30	31
X	X	X	X	X	X	X	X	X	X	X	X	X	X	X

Day Plan 2

Month of Year		Days of Week							Days of Month																				
J	F	M	A	M	J	S	M	T	W	T	F	S	1	2	3	4	5	6	7	8	9	10	11	12	13	14	15	16	
X	X	X	X	X	X	X	X	X	X	X	X	X	X	X	X	X	X	X	X	X	X	X	X	X	X	X	X	X	X
J	A	S	O	N	D								17	18	19	20	21	22	23	24	25	26	27	28	29	30	31		
X	X	X	X	X	X								X	X	X	X	X	X	X	X	X	X	X	X	X	X	X	X	

Day Plan 3

Month of Year		Days of Week							Days of Month																				
J	F	M	A	M	J	S	M	T	W	T	F	S	1	2	3	4	5	6	7	8	9	10	11	12	13	14	15	16	
X	X	X	X	X	X	X	X	X	X	X	X	X	X	X	X	X	X	X	X	X	X	X	X	X	X	X	X	X	X
J	A	S	O	N	D								17	18	19	20	21	22	23	24	25	26	27	28	29	30	31		
X	X	X	X	X	X								X	X	X	X	X	X	X	X	X	X	X	X	X	X	X	X	

Day Plan 4

Month of Year		Days of Week							Days of Month																				
J	F	M	A	M	J	S	M	T	W	T	F	S	1	2	3	4	5	6	7	8	9	10	11	12	13	14	15	16	
X	X	X	X	X	X	X	X	X	X	X	X	X	X	X	X	X	X	X	X	X	X	X	X	X	X	X	X	X	X
J	A	S	O	N	D								17	18	19	20	21	22	23	24	25	26	27	28	29	30	31		
X	X	X	X	X	X								X	X	X	X	X	X	X	X	X	X	X	X	X	X	X	X	

Day Plan 5

Month of Year		Days of Week							Days of Month																				
J	F	M	A	M	J	S	M	T	W	T	F	S	1	2	3	4	5	6	7	8	9	10	11	12	13	14	15	16	
X	X	X	X	X	X	X	X	X	X	X	X	X	X	X	X	X	X	X	X	X	X	X	X	X	X	X	X	X	X
J	A	S	O	N	D								17	18	19	20	21	22	23	24	25	26	27	28	29	30	31		
X	X	X	X	X	X								X	X	X	X	X	X	X	X	X	X	X	X	X	X	X	X	

Day Plan 6

Month of Year		Days of Week							Days of Month																				
J	F	M	A	M	J	S	M	T	W	T	F	S	1	2	3	4	5	6	7	8	9	10	11	12	13	14	15	16	
X	X	X	X	X	X	X	X	X	X	X	X	X	X	X	X	X	X	X	X	X	X	X	X	X	X	X	X	X	X
J	A	S	O	N	D								17	18	19	20	21	22	23	24	25	26	27	28	29	30	31		
X	X	X	X	X	X								X	X	X	X	X	X	X	X	X	X	X	X	X	X	X	X	

Day Plan 7

Month of Year		Days of Week							Days of Month																				
J	F	M	A	M	J	S	M	T	W	T	F	S	1	2	3	4	5	6	7	8	9	10	11	12	13	14	15	16	
X	X	X	X	X	X	X	X	X	X	X	X	X	X	X	X	X	X	X	X	X	X	X	X	X	X	X	X	X	X
J	A	S	O	N	D								17	18	19	20	21	22	23	24	25	26	27	28	29	30	31		
X	X	X	X	X	X								X	X	X	X	X	X	X	X	X	X	X	X	X	X	X	X	

Day Plan 8

Month of Year		Days of Week							Days of Month																				
J	F	M	A	M	J	S	M	T	W	T	F	S	1	2	3	4	5	6	7	8	9	10	11	12	13	14	15	16	
X	X	X	X	X	X	X	X	X	X	X	X	X	X	X	X	X	X	X	X	X	X	X	X	X	X	X	X	X	X
J	A	S	O	N	D								17	18	19	20	21	22	23	24	25	26	27	28	29	30	31		
X	X	X	X	X	X								X	X	X	X	X	X	X	X	X	X	X	X	X	X	X	X	

Day Plan 9

Month of Year		Days of Week							Days of Month																				
J	F	M	A	M	J	S	M	T	W	T	F	S	1	2	3	4	5	6	7	8	9	10	11	12	13	14	15	16	
X	X	X	X	X	X	X	X	X	X	X	X	X	X	X	X	X	X	X	X	X	X	X	X	X	X	X	X	X	X
J	A	S	O	N	D								17	18	19	20	21	22	23	24	25	26	27	28	29	30	31		
X	X	X	X	X	X								X	X	X	X	X	X	X	X	X	X	X	X	X	X	X	X	

Day Plan 10

Month of Year		Days of Week							Days of Month																				
J	F	M	A	M	J	S	M	T	W	T	F	S	1	2	3	4	5	6	7	8	9	10	11	12	13	14	15	16	
X	X	X	X	X	X	X	X	X	X	X	X	X	X	X	X	X	X	X	X	X	X	X	X	X	X	X	X	X	X
J	A	S	O	N	D								17	18	19	20	21	22	23	24	25	26	27	28	29	30	31		
X	X	X	X	X	X								X	X	X	X	X	X	X	X	X	X	X	X	X	X	X	X	

X	X	X	X	X	X
---	---	---	---	---	---

X	X	X	X	X	X	X	X	X	X	X	X	X	X	X	X
---	---	---	---	---	---	---	---	---	---	---	---	---	---	---	---

Day Plan													11																
Month of Year					Days of Week					Days of Month																			
J	F	M	A	M	J	S	M	T	W	T	F	S	1	2	3	4	5	6	7	8	9	10	11	12	13	14	15	16	
J	A	S	O	N	D								17	18	19	20	21	22	23	24	25	26	27	28	29	30	31		

Day Plan													12																
Month of Year					Days of Week					Days of Month																			
J	F	M	A	M	J	S	M	T	W	T	F	S	1	2	3	4	5	6	7	8	9	10	11	12	13	14	15	16	
J	A	S	O	N	D								17	18	19	20	21	22	23	24	25	26	27	28	29	30	31		

Day Plan													13																
Month of Year					Days of Week					Days of Month																			
J	F	M	A	M	J	S	M	T	W	T	F	S	1	2	3	4	5	6	7	8	9	10	11	12	13	14	15	16	
J	A	S	O	N	D								17	18	19	20	21	22	23	24	25	26	27	28	29	30	31		

Day Plan													14																
Month of Year					Days of Week					Days of Month																			
J	F	M	A	M	J	S	M	T	W	T	F	S	1	2	3	4	5	6	7	8	9	10	11	12	13	14	15	16	
J	A	S	O	N	D								17	18	19	20	21	22	23	24	25	26	27	28	29	30	31		

Day Plan													15																
Month of Year					Days of Week					Days of Month																			
J	F	M	A	M	J	S	M	T	W	T	F	S	1	2	3	4	5	6	7	8	9	10	11	12	13	14	15	16	
J	A	S	O	N	D								17	18	19	20	21	22	23	24	25	26	27	28	29	30	31		

Day Plan					1	
Event	Hour	Min.	Act			
1	6	0	1			
2	9	0	2			
3	15	0	3			
4	19	0	2			
5	22	0	20			

Day Plan					2	
Event	Hour	Min.	Act			
1	6	0	1			
2	9	0	4			
3	22	0	20			
4	0	0				
5	0	0				

Day Plan					3	
Event	Hour	Min.	Act			
1	0	0				
2	0	0				
3	0	0				
4	0	0				
5	0	0				

Day Plan					4	
Event	Hour	Min.	Act			
1	0	0				
2	0	0				
3	0	0				
4	0	0				
5	0	0				

Day Plan					1	
Event	Hour	Min.	Act			
6	0	0				
7	0	0				
8	0	0				
9	0	0				
10	0	0				

Day Plan					2	
Event	Hour	Min.	Act			
6	0	0				
7	0	0				
8	0	0				
9	0	0				
10	0	0				

Day Plan					3	
Event	Hour	Min.	Act			
6	0	0				
7	0	0				
8	0	0				
9	0	0				
10	0	0				

Day Plan					4	
Event	Hour	Min.	Act			
6	0	0				
7	0	0				
8	0	0				
9	0	0				
10	0	0				

Day Plan					5	
Event	Hour	Min.	Act			
1	0	0				
2	0	0				
3	0	0				
4	0	0				
5	0	0				
6	0	0				
7	0	0				

Day Plan					6	
Event	Hour	Min.	Act			
1	0	0				
2	0	0				
3	0	0				
4	0	0				
5	0	0				
6	0	0				
7	0	0				

Day Plan					7	
Event	Hour	Min.	Act			
1	0	0				
2	0	0				
3	0	0				
4	0	0				
5	0	0				
6	0	0				
7	0	0				

Day Plan					8	
Event	Hour	Min.	Act			
1	0	0				
2	0	0				
3	0	0				
4	0	0				
5	0	0				
6	0	0				
7	0	0				

8	0	0	
9	0	0	
10	0	0	

8	0	0	
9	0	0	
10	0	0	

8	0	0	
9	0	0	
10	0	0	

8	0	0	
9	0	0	
10	0	0	

Day Plan				9
Event	Hour	Min.	Act	
1	0	0		
2	0	0		
3	0	0		
4	0	0		
5	0	0		
6	0	0		
7	0	0		
8	0	0		
9	0	0		
10	0	0		

Day Plan				10
Event	Hour	Min.	Act	
1	0	0		
2	0	0		
3	0	0		
4	0	0		
5	0	0		
6	0	0		
7	0	0		
8	0	0		
9	0	0		
10	0	0		

Day Plan				11
Event	Hour	Min.	Act	
1	0	0		
2	0	0		
3	0	0		
4	0	0		
5	0	0		
6	0	0		
7	0	0		
8	0	0		
9	0	0		
10	0	0		

Day Plan				12
Event	Hour	Min.	Act	
1	0	0		
2	0	0		
3	0	0		
4	0	0		
5	0	0		
6	0	0		
7	0	0		
8	0	0		
9	0	0		
10	0	0		

Day Plan				13
Event	Hour	Min.	Act	
1	0	0		
2	0	0		
3	0	0		
4	0	0		
5	0	0		
6	0	0		
7	0	0		
8	0	0		
9	0	0		
10	0	0		

Day Plan				14
Event	Hour	Min.	Act	
1	0	0		
2	0	0		
3	0	0		
4	0	0		
5	0	0		
6	0	0		
7	0	0		
8	0	0		
9	0	0		
10	0	0		

Day Plan				15
Event	Hour	Min.	Act	
1	0	0		
2	0	0		
3	0	0		
4	0	0		
5	0	0		
6	0	0		
7	0	0		
8	0	0		
9	0	0		
10	0	0		

Day Plan				16
Event	Hour	Min.	Act	
1	0	0		
2	0	0		
3	0	0		
4	0	0		
5	0	0		
6	0	0		
7	0	0		
8	0	0		
9	0	0		
10	0	0		

Day Plan				17
Event	Hour	Min.	Act	
1	0	0		
2	0	0		
3	0	0		
4	0	0		
5	0	0		
6	0	0		
7	0	0		
8	0	0		
9	0	0		
10	0	0		

Day Plan				18
Event	Hour	Min.	Act	
1	0	0		
2	0	0		
3	0	0		
4	0	0		
5	0	0		
6	0	0		
7	0	0		
8	0	0		
9	0	0		
10	0	0		

Day Plan				19
Event	Hour	Min.	Act	
1	0	0		
2	0	0		
3	0	0		
4	0	0		
5	0	0		
6	0	0		
7	0	0		
8	0	0		
9	0	0		
10	0	0		

Day Plan				20
Event	Hour	Min.	Act	
1	0	0		
2	0	0		
3	0	0		
4	0	0		
5	0	0		
6	0	0		
7	0	0		
8	0	0		
9	0	0		
10	0	0		

Actions		Aux.			Special Functions							
Act	Pattern	1	2	3	1	2	3	4	5	6	7	8
1	Pattern 1											
2	Pattern 2											
3	Pattern 3											
4	Pattern 4											
5	Pattern 5											
6	Pattern 6											
7	Pattern 7											
8	Pattern 8											
9	Pattern 9											
10	Pattern 10											
11	None											
12	None											
13	None											
14	None											
15	None											
16	None											
17	None											
18	None											
19	None											
20	None											

Actions		Aux.			Special Functions							
Act	Pattern	1	2	3	1	2	3	4	5	6	7	8
33	None											
34	None											
35	None											
36	None											
37	None											
38	None											
39	None											
40	None											
41	None											
42	None											
43	None											
44	None											
45	None											
46	None											
47	None											
48	None											
49	None											
50	None											
51	None											
52	None											

21	None								
22	None								
23	None								
24	None								
25	None								
26	None								
27	None								
28	None								
29	None								
30	None								
31	None								
32	None								

53	None								
54	None								
55	None								
56	None								
57	None								
58	None								
59	None								
60	None								
61	None								
62	None								
63	None								
64	None								

Preemption Parameters

Preempt	1	2	3	4	5	6	7	8
Link	0	0	0	0	0	0	0	0
Delay	0	0	0	0	0	0	0	0
Min Duration	0	0	10	10	10	10	0	0
Min Green	0	0	0	0	0	0	0	0
Min Walk	0	0	0	0	0	0	0	0
Ent. Ped Clear	255	255	255	255	255	255	255	255
Track Green	0	0	0	0	0	0	0	0
Dwell Green	0	0	5	5	5	5	0	0
Max Presence	0	0	0	0	0	0	0	0
Enter Yellow	25.5	25.5	25.5	25.5	25.5	25.5	25.5	25.5
Ent. Red Clear	25.5	25.5	25.5	25.5	25.5	25.5	25.5	25.5

Preemption Parameters

Preempt	1	2	3	4	5	6	7	8
Track Yellow	25.5	25.5	25.5	25.5	25.5	25.5	25.5	25.5
Track Red Clear	25.5	25.5	25.5	25.5	25.5	25.5	25.5	25.5
Exit Red	25.5	25.5	25.5	25.5	25.5	25.5	25.5	25.5
Exit Ped Clear	255	255	255	255	255	255	255	255
Exit Yellow	25.5	25.5	25.5	25.5	25.5	25.5	25.5	25.5
Exit Red	25.5	25.5	25.5	25.5	25.5	25.5	25.5	25.5
Preempt	1	2	3	4	5	6	7	8
Non Lock Mem								
Not Override Flash								
NotOverrideNextPre								
Flash Dwell								

Preemption Configuration

Preempt	1	2	3	4	5	6	7	8
Track phase								
Dwell Phase			2,5	3,8	1,6	4,7		
Dwell Ped								
Exit Phase								
Track Overlap								
Dwell overlap								
Cycling phase								
Cycling Ped								
Cycling Overlap								

IO Modules

IO Mod	TYPE
1	Caltrans 332
2	None
3	None
4	None
5	None
6	None
7	None
8	None
9	None
10	None

Channel Configuration

Chan	Ctrl Type	Source
1	Phs Veh	1
2	Phs Veh	2
3	Olp	3
4	Olp	4
5	Phs Veh	5
6	Phs Veh	6
7	Olp	7
8	Olp	8
9	Olp	1
10	Olp	2

Chan	Ctrl Type	Source
11	Olp	3
12	Olp	4
13	Phs Ped	2
14	Phs Ped	4
15	Phs Ped	6
16	Phs Ped	8
17	Olp	5
18	Olp	6
19	None	0
20	None	0

Channel Options

Channel	1	2	3	4	5	6	7	8	9	10	11	12	13	14	15	16
Flash Yellow																
Flash Red	X	X	X	X	X	X	X	X								
Alt Flash	X			X	X			X								
Channel	17	18	19	20	21	22	23	24	25	26	27	28	29	30	31	32
Flash Yellow																
Flash Red																
Alt Flash																

Startup Clearance Hold Type

1=off, 2=On, 3=Flash and 4= Alt Flash

Channel	1	2	3	4	5	6	7	8	9	10	11	12	13	14	15	16
Red																
Yellow																
Green																
Channel	17	18	19	20	21	22	23	24	25	26	27	28	29	30	31	32
Red																
Yellow																
Green																

Phase Intervals

Interval	Description	Red	Yel	Grn	Type
1	notActive	On	Off	Off	Red
2	dltGrn	On	Off	Off	Red
3	PreGrn	Off	Off	On	Green
4	minGrn	Off	Off	On	Green
5	grnExt	Off	Off	On	Green
6	grnDwell	Off	Off	On	Green
7	preClear	Off	Off	On	Green
8	yelChange	Off	On	Off	Yellow
9	redClear	On	Off	Off	Red
10	redDwell	On	Off	Off	Red
11	Barrier	On	Off	Off	Red
12					

Pedestrian Intervals

Interval	Description	DWK	CLR	Wlk	Type
1	notActive	On	Off	Off	Dont Walk
2	dltPed	On	Off	Off	Dont Walk
3	walk	Off	Off	On	Walk
4	walkDwell	Off	Off	On	Walk
5	flashDtWlk	Flash	Off	Off	Ped Clear
6	dWalk	On	Off	Off	Dont Walk
7					
8					

Countdown Display

Display	Addr	Phase	Time
1			
2			
3			
4			
5			
6			
7			
8			

Display	Addr	Phase	Time
9			
10			
11			
12			
13			
14			
15			
16			

Display	Addr	Phase	Time
17			
18			
19			
20			
21			
22			
23			
24			

Display	Addr	Phase	Time
25			
26			
27			
28			
29			
30			
31			
32			

Manual Control Phase Groups

Grp 1	Grp 2	Grp 3	Grp 4	Grp 5	Grp 6	Grp 7	Grp 8
Ring	Ph	Ring	Ph	Ring	Ph	Ring	Ph
1	0	1	0	1	0	1	0
2	0	2	0	2	0	2	0
3	0	3	0	3	0	3	0
4	0	4	0	4	0	4	0
5	0	5	0	5	0	5	0
6	0	6	0	6	0	6	0
7	0	7	0	7	0	7	0
8	0	8	0	8	0	8	0
9	0	9	0	9	0	9	0
10	0	10	0	10	0	10	0
11	0	11	0	11	0	11	0
12	0	12	0	12	0	12	0
13	0	13	0	13	0	13	0
14	0	14	0	14	0	14	0
15	0	15	0	15	0	15	0
16	0	16	0	16	0	16	0

Prioritor Settings

Prioritor	Priority Ph	Output Dly
1		0
2		0
3		0
4		0
5		0
6		0

Enabled	Lock Out Time
No	0

7		0
8		0

Loopback Functions

Func	Result Function Type	Index	Source Function Type	Index	Func	Result Function Type	Index	Source Function Type	Index
1					51				
2					52				
3					53				
4					54				
5					55				
6					56				
7					57				
8					58				
9					59				
10					60				
11					61				
12					62				
13					63				
14					64				
15					65				
16					66				
17					67				
18					68				
19					69				
20					70				
21					71				
22					72				
23					73				
24					74				
25					75				
26					76				
27					77				
28					78				
29					79				
30					80				
31					81				
32					82				
33					83				
34					84				
35					85				
36					86				
37					87				
38					88				
39					89				
40					90				
41					91				
42					92				
43					93				
44					94				
45					95				
46					96				
47					97				
48					98				
49					99				
50					100				

Peer Configuration

Ctrl	Peer ID	IP address	SNMP Port	Hot Port	Serial Port	Serial Addr.	Master Sect.	P2P TO	Description
1	0		161	80	0	0	0	15	
2	0		161	80	0	0	0	15	
3	0		161	80	0	0	0	15	
4	0		161	80	0	0	0	15	
5	0		161	80	0	0	0	15	

6	0		161	80	0	0	0	15	
7	0		161	80	0	0	0	15	
8	0		161	80	0	0	0	15	
9	0		161	80	0	0	0	15	
10	0		161	80	0	0	0	15	
11	0		161	80	0	0	0	15	
12	0		161	80	0	0	0	15	
13	0		161	80	0	0	0	15	
14	0		161	80	0	0	0	15	
15	0		161	80	0	0	0	15	
16	0		161	80	0	0	0	15	
17	0		161	80	0	0	0	15	
18	0		161	80	0	0	0	15	
19	0		161	80	0	0	0	15	
20	0		161	80	0	0	0	15	
21	0		161	80	0	0	0	15	
22	0		161	80	0	0	0	15	
23	0		161	80	0	0	0	15	
24	0		161	80	0	0	0	15	
25	0		161	80	0	0	0	15	
26	0		161	80	0	0	0	15	
27	0		161	80	0	0	0	15	
28	0		161	80	0	0	0	15	
29	0		161	80	0	0	0	15	
30	0		161	80	0	0	0	15	
31	0		161	80	0	0	0	15	
32	0		161	80	0	0	0	15	
33	0		161	80	0	0	0	15	
34	0		161	80	0	0	0	15	
35	0		161	80	0	0	0	15	
36	0		161	80	0	0	0	15	
37	0		161	80	0	0	0	15	
38	0		161	80	0	0	0	15	
39	0		161	80	0	0	0	15	
40	0		161	80	0	0	0	15	
41	0		161	80	0	0	0	15	
42	0		161	80	0	0	0	15	
43	0		161	80	0	0	0	15	
44	0		161	80	0	0	0	15	
45	0		161	80	0	0	0	15	
46	0		161	80	0	0	0	15	
47	0		161	80	0	0	0	15	
48	0		161	80	0	0	0	15	
49	0		161	80	0	0	0	15	
50	0		161	80	0	0	0	15	
51	0		161	80	0	0	0	15	
52	0		161	80	0	0	0	15	
53	0		161	80	0	0	0	15	
54	0		161	80	0	0	0	15	
55	0		161	80	0	0	0	15	
56	0		161	80	0	0	0	15	
57	0		161	80	0	0	0	15	
58	0		161	80	0	0	0	15	
59	0		161	80	0	0	0	15	
60	0		161	80	0	0	0	15	
61	0		161	80	0	0	0	15	
62	0		161	80	0	0	0	15	
63	0		161	80	0	0	0	15	
64	0		161	80	0	0	0	15	
65	0		161	80	0	0	0	15	
66	0		161	80	0	0	0	15	
67	0		161	80	0	0	0	15	
68	0		161	80	0	0	0	15	

69	0		161	80	0	0	0	15	
70	0		161	80	0	0	0	15	
71	0		161	80	0	0	0	15	
72	0		161	80	0	0	0	15	
73	0		161	80	0	0	0	15	
74	0		161	80	0	0	0	15	
75	0		161	80	0	0	0	15	
76	0		161	80	0	0	0	15	
77	0		161	80	0	0	0	15	
78	0		161	80	0	0	0	15	
79	0		161	80	0	0	0	15	
80	0		161	80	0	0	0	15	
81	0		161	80	0	0	0	15	
82	0		161	80	0	0	0	15	
83	0		161	80	0	0	0	15	
84	0		161	80	0	0	0	15	
85	0		161	80	0	0	0	15	
86	0		161	80	0	0	0	15	
87	0		161	80	0	0	0	15	
88	0		161	80	0	0	0	15	
89	0		161	80	0	0	0	15	
90	0		161	80	0	0	0	15	
91	0		161	80	0	0	0	15	
92	0		161	80	0	0	0	15	
93	0		161	80	0	0	0	15	
94	0		161	80	0	0	0	15	
95	0		161	80	0	0	0	15	
96	0		161	80	0	0	0	15	
97	0		161	80	0	0	0	15	
98	0		161	80	0	0	0	15	
99	0		161	80	0	0	0	15	
100	0		161	80	0	0	0	15	
101	0		161	80	0	0	0	15	
102	0		161	80	0	0	0	15	
103	0		161	80	0	0	0	15	
104	0		161	80	0	0	0	15	
105	0		161	80	0	0	0	15	
106	0		161	80	0	0	0	15	
107	0		161	80	0	0	0	15	
108	0		161	80	0	0	0	15	
109	0		161	80	0	0	0	15	
110	0		161	80	0	0	0	15	
111	0		161	80	0	0	0	15	
112	0		161	80	0	0	0	15	
113	0		161	80	0	0	0	15	
114	0		161	80	0	0	0	15	

CDOT

MaxTime Timing Shee

I-25 and Meadows Pkwy ER

Administration

Unit Information

Controller ID	0
Main St.	I-25
Side St.	Meadows Pkwy ER

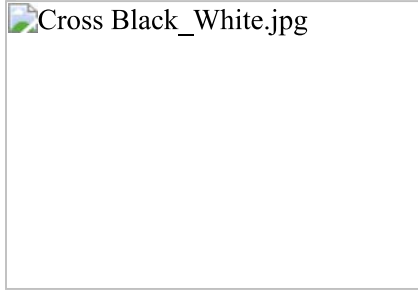

Adapter	IP Address	Subnet Mask	Default Gateway	ARP	DHCP
1	10.11.79.125	255.255.255.0	10.11.79.1	Disable	
2	10.20.70.51	255.255.255.0	0.0.0.0	Disable	

Serial Ports:

Port	Description	Function	Address	Baud	Bits	Stop	Parity	Flow	CTS	RTS
1	Port 2/C21S	None	1	9600	8	1	None	None	0	0
2	Aux_P3/C22S	None	1	9600	8	1	None	None	0	0
3	SDLC Port 1	None	1	9600	8	1	None	None	0	0
4	Com A/C50S	None	1	9600	8	1	None	None	0	0
5	FIO	None	1	9600	8	1	None	None	0	0
6	DISPLAY/C60M	None	1	9600	8	1	None	None	0	0
7	SP7	None	1	9600	8	1	None	None	0	0
8	SP8/Com B	None	1	9600	8	1	None	None	0	0

Unit Parameters

Startup Flash	0	Auto Ped Clr	Enable	Red Revert	4.0	Backup Time	600	Ext Mode	Enable
All Red Exit	6	Grn Flash Freq.	60	Yel Flash Freq.	60	MCE Enable	Enable	Free Seq.	1
MCE Seq.	1	Start Yellow	0.0	Start Red	0.0	Start Clear Hold	6		

Phase Parameters

Phases	1	2	3	4	5	6	7	8	9	10	11	12	13	14	15	16	17	18	19	20
Walk Time	0	7	0	0	0	7	0	0	0	0	0	0	0	0	0	0	0	0	0	0
Clear Time	0	10	0	0	0	10	0	0	0	0	0	0	0	0	0	0	0	0	0	0
Don't Walk	0	0	0	0	0	0	0	0	0	0	0	0	0	0	0	0	0	0	0	0
Min Green	0	20	0	5	0	20	0	0	1	1	1	1	1	1	1	1	1	1	1	1
Min Green 2	0	0	0	0	0	0	0	0	0	0	0	0	0	0	0	0	0	0	0	0
Passage	0.0	6.0	0.0	5.0	0.0	6.0	0.0	0.0	0.0	0.0	0.0	0.0	0.0	0.0	0.0	0.0	0.0	0.0	0.0	0.0
Max-1	0	95	0	40	0	95	0	0	0	0	0	0	0	0	0	0	0	0	0	0
Max-2	0	0	0	0	0	0	0	0	0	0	0	0	0	0	0	0	0	0	0	0
Max-3	0	0	0	0	0	0	0	0	0	0	0	0	0	0	0	0	0	0	0	0
Yel Change	0.0	4.0	0.0	3.0	0.0	4.0	0.0	0.0	3.0	3.0	3.0	3.0	3.0	3.0	3.0	3.0	3.0	3.0	3.0	3.0
Red Clear	2.0	2.0	2.0	2.0	2.0	2.0	2.0	2.0	0.0	0.0	0.0	0.0	0.0	0.0	0.0	0.0	0.0	0.0	0.0	0.0
Add Red Clear	0	0	0	0	0	0	0	0	0	0	0	0	0	0	0	0	0	0	0	0
Red Revert	0.0	0.0	0.0	0.0	0.0	0.0	0.0	0.0	0.0	0.0	0.0	0.0	0.0	0.0	0.0	0.0	0.0	0.0	0.0	0.0
Added Initial	0.0	0.0	0.0	0.0	0.0	0.0	0.0	0.0	0.0	0.0	0.0	0.0	0.0	0.0	0.0	0.0	0.0	0.0	0.0	0.0
Max Initial	0.0	0.0	0.0	0.0	0.0	0.0	0.0	0.0	0.0	0.0	0.0	0.0	0.0	0.0	0.0	0.0	0.0	0.0	0.0	0.0
Time B4 Reduce	0	0	0	0	0	0	0	0	0	0	0	0	0	0	0	0	0	0	0	0
Cars B4 Reduce	0	0	0	0	0	0	0	0	0	0	0	0	0	0	0	0	0	0	0	0
Time To Reduce	0	0	0	0	0	0	0	0	0	0	0	0	0	0	0	0	0	0	0	0
Reduce By	0.0	0.0	0.0	0.0	0.0	0.0	0.0	0.0	0.0	0.0	0.0	0.0	0.0	0.0	0.0	0.0	0.0	0.0	0.0	0.0
Min Gap	0.0	6.0	0.0	5.0	0.0	6.0	0.0	0.0	0.0	0.0	0.0	0.0	0.0	0.0	0.0	0.0	0.0	0.0	0.0	0.0
Dyn Max Limit	0	0	0	0	0	0	0	0	0	0	0	0	0	0	0	0	0	0	0	0
Dyn Max Step	0.0	0.0	0.0	0.0	0.0	0.0	0.0	0.0	0.0	0.0	0.0	0.0	0.0	0.0	0.0	0.0	0.0	0.0	0.0	0.0
Advance Walk	0	0	0	0	0	0	0	0	0	0	0	0	0	0	0	0	0	0	0	0
Delay Ped	0	0	0	0	0	0	0	0	0	0	0	0	0	0	0	0	0	0	0	0
Alt Walk	0	0	0	0	0	0	0	0	0	0	0	0	0	0	0	0	0	0	0	0
Alt Ped Clr																				
Pre Green	0.0	0.0	0.0	0.0	0.0	0.0	0.0	0.0	0.0	0.0	0.0	0.0	0.0	0.0	0.0	0.0	0.0	0.0	0.0	0.0
Pre Clearance	0.0	0.0	0.0	0.0	0.0	0.0	0.0	0.0	0.0	0.0	0.0	0.0	0.0	0.0	0.0	0.0	0.0	0.0	0.0	0.0

Phases	21	22	23	24	25	26	27	28	29	30	31	32	33	34	35	36	37	38	39	40
Walk Time	0	0	0	0	0	0	0	0	0	0	0	0	0	0	0	0	0	0	0	0
Clear Time	0	0	0	0	0	0	0	0	0	0	0	0	0	0	0	0	0	0	0	0
Don't Walk	0	0	0	0	0	0	0	0	0	0	0	0	0	0	0	0	0	0	0	0
Min Green	1	1	1	1	1	1	1	1	1	1	1	1	1	1	1	1	1	1	1	1

Min Green 2	0	0	0	0	0	0	0	0	0	0	0	0	0	0	0	0	0	0	0
Passage	0.0	0.0	0.0	0.0	0.0	0.0	0.0	0.0	0.0	0.0	0.0	0.0	0.0	0.0	0.0	0.0	0.0	0.0	0.0
Max-1	0	0	0	0	0	0	0	0	0	0	0	0	0	0	0	0	0	0	0
Max-2	0	0	0	0	0	0	0	0	0	0	0	0	0	0	0	0	0	0	0
Max-3	0	0	0	0	0	0	0	0	0	0	0	0	0	0	0	0	0	0	0
Yel Change	3.0	3.0	3.0	3.0	3.0	3.0	3.0	3.0	3.0	3.0	3.0	3.0	3.0	3.0	3.0	3.0	3.0	3.0	3.0
Red Clear	0.0	0.0	0.0	0.0	0.0	0.0	0.0	0.0	0.0	0.0	0.0	0.0	0.0	0.0	0.0	0.0	0.0	0.0	0.0
Add Red Clear	0	0	0	0	0	0	0	0	0	0	0	0	0	0	0	0	0	0	0
Red Revert	0.0	0.0	0.0	0.0	0.0	0.0	0.0	0.0	0.0	0.0	0.0	0.0	0.0	0.0	0.0	0.0	0.0	0.0	0.0
Added Initial	0.0	0.0	0.0	0.0	0.0	0.0	0.0	0.0	0.0	0.0	0.0	0.0	0.0	0.0	0.0	0.0	0.0	0.0	0.0
Max Initial	0.0	0.0	0.0	0.0	0.0	0.0	0.0	0.0	0.0	0.0	0.0	0.0	0.0	0.0	0.0	0.0	0.0	0.0	0.0
Time B4 Reduce	0	0	0	0	0	0	0	0	0	0	0	0	0	0	0	0	0	0	0
Cars B4 Reduce	0	0	0	0	0	0	0	0	0	0	0	0	0	0	0	0	0	0	0
Time To Reduce	0	0	0	0	0	0	0	0	0	0	0	0	0	0	0	0	0	0	0
Reduce By	0.0	0.0	0.0	0.0	0.0	0.0	0.0	0.0	0.0	0.0	0.0	0.0	0.0	0.0	0.0	0.0	0.0	0.0	0.0
Min Gap	0.0	0.0	0.0	0.0	0.0	0.0	0.0	0.0	0.0	0.0	0.0	0.0	0.0	0.0	0.0	0.0	0.0	0.0	0.0
Dyn Max Limit	0	0	0	0	0	0	0	0	0	0	0	0	0	0	0	0	0	0	0
Dyn Max Step	0.0	0.0	0.0	0.0	0.0	0.0	0.0	0.0	0.0	0.0	0.0	0.0	0.0	0.0	0.0	0.0	0.0	0.0	0.0
Advance Walk	0	0	0	0	0	0	0	0	0	0	0	0	0	0	0	0	0	0	0
Delay Ped	0	0	0	0	0	0	0	0	0	0	0	0	0	0	0	0	0	0	0
Alt Walk	0	0	0	0	0	0	0	0	0	0	0	0	0	0	0	0	0	0	0
Alt Ped Clr																			
Pre Green	0.0	0.0	0.0	0.0	0.0	0.0	0.0	0.0	0.0	0.0	0.0	0.0	0.0	0.0	0.0	0.0	0.0	0.0	0.0
Pre Clearance	0.0	0.0	0.0	0.0	0.0	0.0	0.0	0.0	0.0	0.0	0.0	0.0	0.0	0.0	0.0	0.0	0.0	0.0	0.0

Phase Options

Phases	1	2	3	4	5	6	7	8	9	10	11	12	13	14	15	16	17	18	19	20
Enable	X	X	X	X	X	X	X	X												
Auto Flash Ent.		X				X														
Auto Flash Exit				X				X												
Non Actuated I																				
Non Actuated II																				
Non Lock Mem	X	X	X	X	X	X	X	X												
Min Veh Recall		X				X														
Max Veh Recall																				
Ped Recall																				
Soft Veh Recall																				
Dual Entry																				
Sim Gap Dis																				
Guaranteed Pass																				
Act Rest Walk																				
Cond Service																				
Add Initial																				

Phases	21	22	23	24	25	26	27	28	29	30	31	32	33	34	35	36	37	38	39	40
Enable																				
Auto Flash Ent.																				
Auto Flash Exit																				
Non Actuated I																				
Non Actuated II																				
Non Lock Mem																				
Min Veh Recall																				
Max Veh Recall																				
Ped Recall																				
Soft Veh Recall																				
Dual Entry																				
Sim Gap Dis																				
Guaranteed Pass																				
Act Rest Walk																				
Cond Service																				
Add Initial																				

Additional Phase Options

--	--	--	--	--	--	--	--	--	--	--	--	--	--	--	--	--	--	--	--	--

Phases	1	2	3	4	5	6	7	8	9	10	11	12	13	14	15	16	17	18	19	20
Ped Clr During Yel																				
Ped Clr During Red																				
Cond Reservice																				
Yel Min Override	X	X	X	X	X	X	X	X												
No Startup Call																				
Adv. Warn Flasher																				
No Ped Str Up Call																				
Ped Clr OVTG																				
Flash Exit Call																				
Flash Exit Ped Call																				
MinGreen2																				
MaxGreen2																				
MaxGreen3																				
Ped2																				
Ped Clear Pre Clear																				
Ped NA+ Mode																				
Red Rest																				
Serve Evy Oth Even																				
Serve Evy Oth Odd																				

Phases	21	22	23	24	25	26	27	28	29	30	31	32	33	34	35	36	37	38	39	40
Ped Clr During Yel																				
Ped Clr During Red																				
Cond Reservice																				
Yel Min Override																				
No Startup Call																				
Adv. Warn Flasher																				
No Ped Str Up Call																				
Ped Clr OVTG																				
Flash Exit Call																				
Flash Exit Ped Call																				
MinGreen2																				
MaxGreen2																				
MaxGreen3																				
Ped2																				
Ped Clear Pre Clear																				
Ped NA+ Mode																				
Red Rest																				
Serve Evy Oth Even																				
Serve Evy Oth Odd																				

Phase Configuration

Ph.	Startup	Ring	Concurrent	No Served Phases	Startup Min	Description
1	Phase Not On	0			0	SBLT
2	Green No Walk	1	6		0	NBT
3	Phase Not On	0			0	WBLT
4	Phase Not On	1			0	EBT
5	Phase Not On	0			0	NBLT
6	Green No Walk	2	2		0	SBT
7	Phase Not On	0			0	EBLT
8	Phase Not On	0			0	WBT
9	None	0			0	
10	None	0			0	
11	None	0			0	
12	None	0			0	
13	None	0			0	
14	None	0			0	
15	None	0			0	
16	None	0			0	
17	None	0			0	
18	None	0			0	
19	None	0			0	
20	None	0			0	

21	None	0			0	
22	None	0			0	
23	None	0			0	
24	None	0			0	
25	None	0			0	
26	None	0			0	
27	None	0			0	
28	None	0			0	
29	None	0			0	
30	None	0			0	
31	None	0			0	
32	None	0			0	
33	None	0			0	
34	None	0			0	
35	None	0			0	
36	None	0			0	
37	None	0			0	
38	None	0			0	
39	None	0			0	
40	None	0			0	

Sequence Configuration

Sequence 1

Ring	Phases
1	2,a,4,b
2	6,a,b
3	
4	
5	
6	
7	
8	
9	
10	
11	
12	
13	
14	
15	
16	

Sequence 2

Ring	Phases
1	2,a,4,b
2	6,a,b
3	
4	
5	
6	
7	
8	
9	
10	
11	
12	
13	
14	
15	
16	

Sequence 3

Ring	Phases
1	2,a,4,b
2	6,a,b
3	
4	
5	
6	
7	
8	
9	
10	
11	
12	
13	
14	
15	
16	

Sequence 4

Ring	Phases
1	2,a,4,b
2	6,a,b
3	
4	
5	
6	
7	
8	
9	
10	
11	
12	
13	
14	
15	
16	

Sequence 5

Ring	Phases
1	1,2,a,3,4,b
2	6,5,a,7,8,b
3	
4	
5	
6	
7	
8	
9	
10	
11	
12	
13	
14	
15	
16	

Sequence 6

Ring	Phases
1	2,1,a,3,4,b
2	6,5,a,7,8,b
3	
4	
5	
6	
7	
8	
9	
10	
11	
12	
13	
14	
15	
16	

Sequence 7

Ring	Phases
1	1,2,a,4,3,b
2	6,5,a,7,8,b
3	
4	
5	
6	
7	
8	
9	
10	
11	
12	
13	
14	
15	
16	

Sequence 8

Ring	Phases
1	2,1,a,4,3,b
2	6,5,a,7,8,b
3	
4	
5	
6	
7	
8	
9	
10	
11	
12	
13	
14	
15	
16	

Sequence 9

Ring	Phases
1	1,2,a,3,4,b

Sequence 10

Ring	Phases
1	2,1,a,3,4,b

Sequence 11

Ring	Phases
1	1,2,a,4,3,b

Sequence 12

Ring	Phases
1	2,1,a,4,3,b

2	5,6,a,8,7,b
3	
4	
5	
6	
7	
8	
9	
10	
11	
12	
13	
14	
15	
16	

2	5,6,a,8,7,b
3	
4	
5	
6	
7	
8	
9	
10	
11	
12	
13	
14	
15	
16	

2	5,6,a,8,7,b
3	
4	
5	
6	
7	
8	
9	
10	
11	
12	
13	
14	
15	
16	

2	5,6,a,8,7,b
3	
4	
5	
6	
7	
8	
9	
10	
11	
12	
13	
14	
15	
16	

Sequence 13

Ring	Phases
1	1,2,a,3,4,b
2	6,5,a,8,7,b
3	
4	
5	
6	
7	
8	
9	
10	

Sequence 14

Ring	Phases
1	2,1,a,3,4,b
2	6,5,a,8,7,b
3	
4	
5	
6	
7	
8	
9	
10	

Sequence 15

Ring	Phases
1	1,2,a,4,3,b
2	6,5,a,8,7,b
3	
4	
5	
6	
7	
8	
9	
10	

Sequence 16

Ring	Phases
1	2,1,a,4,3,b
2	6,5,a,8,7,b
3	
4	
5	
6	
7	
8	
9	
10	

Sequence 13

11	
12	
13	
14	
15	
16	

Sequence 14

11	
12	
13	
14	
15	
16	

Sequence 15

11	
12	
13	
14	
15	
16	

Sequence 16

11	
12	
13	
14	
15	
16	

Sequence 17

Ring	Phases
1	
2	
3	
4	
5	
6	
7	
8	
9	
10	
11	
12	
13	
14	
15	
16	

Sequence 18

Ring	Phases
1	
2	
3	
4	
5	
6	
7	
8	
9	
10	
11	
12	
13	
14	
15	
16	

Sequence 19

Ring	Phases
1	
2	
3	
4	
5	
6	
7	
8	
9	
10	
11	
12	
13	
14	
15	
16	

Sequence 20

Ring	Phases
1	2,a,4,b
2	6,a,b
3	
4	
5	
6	
7	
8	
9	
10	
11	
12	
13	
14	
15	
16	

Vehicle Detection Parameters

Det.	Call Phs	Call OVI	Additional Call Phase	Switch Phase	Delay	Extend	Queue Limit	No Activity	Max Presence	Erratic Counts	Failed Time	Description
1	1	0		0	0.0	0.0	0	0	0	0	0	
2	2	0		0	0.0	0.0	0	0	0	0	0	
3	2	0		0	0.0	0.0	0	0	0	0	0	
4	2	0		0	0.0	0.0	0	0	0	0	0	

5	2	0		0	0.0	0.0	0	0	0	0	0
6	2	0		0	0.0	0.0	0	0	0	0	0
7	3	0		0	0.0	0.0	0	0	0	0	0
8	4	0		0	0.0	0.0	0	0	0	0	0
9	4	0		0	0.0	0.0	0	0	0	0	0
10	4	0		0	0.0	0.0	0	0	0	0	0
11	4	0		0	0.0	0.0	0	0	0	0	0
12	4	0		0	0.0	0.0	0	0	0	0	0
13	1	0		0	0.0	0.0	0	0	0	0	0
14	3	0		0	0.0	0.0	0	0	0	0	0
15	5	0		0	0.0	0.0	0	0	0	0	0
16	6	0		0	0.0	0.0	0	0	0	0	0
17	6	0		0	0.0	0.0	0	0	0	0	0
18	6	0		0	0.0	0.0	0	0	0	0	0
19	6	0		0	0.0	0.0	0	0	0	0	0
20	6	0		0	0.0	0.0	0	0	0	0	0
21	7	0		0	0.0	0.0	0	0	0	0	0
22	8	0		0	0.0	0.0	0	0	0	0	0
23	8	0		0	0.0	0.0	0	0	0	0	0
24	8	0		0	0.0	0.0	0	0	0	0	0
25	8	0		0	0.0	0.0	0	0	0	0	0
26	8	0		0	0.0	0.0	0	0	0	0	0
27	5	0		0	0.0	0.0	0	0	0	0	0
28	7	0		0	0.0	0.0	0	0	0	0	0
29	0	0		0	0.0	0.0	0	0	0	0	0
30	0	0		0	0.0	0.0	0	0	0	0	0
31	0	0		0	0.0	0.0	0	0	0	0	0
32	0	0		0	0.0	0.0	0	0	0	0	0
33	0	0		0	0.0	0.0	0	0	0	0	0
34	0	0		0	0.0	0.0	0	0	0	0	0
35	0	0		0	0.0	0.0	0	0	0	0	0
36	0	0		0	0.0	0.0	0	0	0	0	0
37	0	0		0	0.0	0.0	0	0	0	0	0
38	0	0		0	0.0	0.0	0	0	0	0	0
39	0	0		0	0.0	0.0	0	0	0	0	0
40	0	0		0	0.0	0.0	0	0	0	0	0
41	0	0		0	0.0	0.0	0	0	0	0	0
42	0	0		0	0.0	0.0	0	0	0	0	0
43	0	0		0	0.0	0.0	0	0	0	0	0
44	0	0		0	0.0	0.0	0	0	0	0	0
45	0	0		0	0.0	0.0	0	0	0	0	0
46	0	0		0	0.0	0.0	0	0	0	0	0
47	0	0		0	0.0	0.0	0	0	0	0	0
48	0	0		0	0.0	0.0	0	0	0	0	0
49	0	0		0	0.0	0.0	0	0	0	0	0
50	0	0		0	0.0	0.0	0	0	0	0	0
51	0	0		0	0.0	0.0	0	0	0	0	0
52	0	0		0	0.0	0.0	0	0	0	0	0
53	0	0		0	0.0	0.0	0	0	0	0	0
54	0	0		0	0.0	0.0	0	0	0	0	0
55	0	0		0	0.0	0.0	0	0	0	0	0
56	0	0		0	0.0	0.0	0	0	0	0	0
57	0	0		0	0.0	0.0	0	0	0	0	0
58	0	0		0	0.0	0.0	0	0	0	0	0
59	0	0		0	0.0	0.0	0	0	0	0	0
60	0	0		0	0.0	0.0	0	0	0	0	0
61	0	0		0	0.0	0.0	0	0	0	0	0
62	0	0		0	0.0	0.0	0	0	0	0	0
63	0	0		0	0.0	0.0	0	0	0	0	0
64	0	0		0	0.0	0.0	0	0	0	0	0
65	0	0		0	0.0	0.0	0	0	0	0	0
66	0	0		0	0.0	0.0	0	0	0	0	0
67	0	0		0	0.0	0.0	0	0	0	0	0
68	0	0		0	0.0	0.0	0	0	0	0	0

69	0	0		0	0.0	0.0	0	0	0	0	0	
70	0	0		0	0.0	0.0	0	0	0	0	0	
71	0	0		0	0.0	0.0	0	0	0	0	0	
72	0	0		0	0.0	0.0	0	0	0	0	0	

Vehicle Detection Options

Detector	1	2	3	4	5	6	7	8	9	10	11	12	13	14	15	16	17	18	19	20
Volume Detector	X	X	X	X	X	X	X	X	X	X	X	X	X	X	X	X	X	X	X	X
Occupancy	X	X	X	X	X	X	X	X	X	X	X	X	X	X	X	X	X	X	X	X
Yellow Lock Call																				
Red Lock call																				
Passage	X	X	X	X	X		X	X	X	X	X		X	X	X	X	X	X	X	
Queue																				
Call	X	X	X	X		X	X	X	X	X		X	X	X	X	X	X	X		X
Terminate																				

Detector	21	22	23	24	25	26	27	28	29	30	31	32	33	34	35	36	37	38	39	40
Volume Detector	X	X	X	X	X	X	X	X												
Occupancy	X	X	X	X	X	X	X	X												
Yellow Lock Call																				
Red Lock call			X																	
Passage	X	X	X	X	X	X	X	X												
Queue																				
Call	X	X	X	X	X	X	X	X												
Terminate																				

Detector	41	42	43	44	45	46	47	48	49	50	51	52	53	54	55	56	57	58	59	60
Volume Detector																				
Occupancy																				
Yellow Lock Call																				
Red Lock call																				
Passage																				
Queue																				
Call																				
Terminate																				

Detector	61	62	63	64	65	66	67	68	69	70	71	72
Volume Detector												
Occupancy												
Yellow Lock Call												
Red Lock call												
Passage												
Queue												
Call												
Terminate												

Data Collection Period	60
------------------------	----

Pedestrian Detectors

Det	Call Phase	Call Ovp	No Act	Max Presence	Erratic Count
1	0	0	0	0	0
2	2	0	0	0	0
3	0	0	0	0	0
4	4	0	0	0	0
5	0	0	0	0	0
6	6	0	0	0	0
7	0	0	0	0	0
8	8	0	0	0	0
9	0	0	0	0	0
10	0	0	0	0	0
11	0	0	0	0	0
12	0	0	0	0	0
13	0	0	0	0	0
14	0	0	0	0	0

Det	Call Phase	Call Ovp	No Act	Max Presence	Erratic Count
21	0	0	0	0	0
22	0	0	0	0	0
23	0	0	0	0	0
24	0	0	0	0	0
25	0	0	0	0	0
26	0	0	0	0	0
27	0	0	0	0	0
28	0	0	0	0	0
29	0	0	0	0	0
30	0	0	0	0	0
31	0	0	0	0	0
32	0	0	0	0	0
33	0	0	0	0	0
34	0	0	0	0	0

15	0	0	0	0	0
16	0	0	0	0	0
17	0	0	0	0	0
18	0	0	0	0	0
19	0	0	0	0	0
20	0	0	0	0	0

35	0	0	0	0	0
36	0	0	0	0	0
37	0	0	0	0	0
38	0	0	0	0	0
39	0	0	0	0	0
40	0	0	0	0	0

Overlaps

OLP	Type	Included Phases	Modifier Phases	Trail		Walk		Ped		Delay	Flash	Descriptions	
				GRN	YEL	RED	1	Clr 1	2				Clr 2
1	Off			0	0.0	0.0	0	0	0	0	0.0	Off	
2	Off			0	0.0	0.0	0	0	0	0	0.0	Off	
3	Off			0	0.0	0.0	0	0	0	0	0.0	Off	
4	Off			0	0.0	0.0	0	0	0	0	0.0	Off	
5	Off			0	0.0	0.0	0	0	0	0	0.0	Off	
6	Off			0	0.0	0.0	0	0	0	0	0.0	Off	
7	Off			0	0.0	0.0	0	0	0	0	0.0	Off	
8	Off			0	0.0	0.0	0	0	0	0	0.0	Off	
9	Off			0	0.0	0.0	0	0	0	0	0.0	Off	
10	Off			0	0.0	0.0	0	0	0	0	0.0	Off	
11	Off			0	0.0	0.0	0	0	0	0	0.0	Off	
12	Off			0	0.0	0.0	0	0	0	0	0.0	Off	
13	Off			0	0.0	0.0	0	0	0	0	0.0	Off	
14	Off			0	0.0	0.0	0	0	0	0	0.0	Off	
15	Off			0	0.0	0.0	0	0	0	0	0.0	Off	
16	Off			0	0.0	0.0	0	0	0	0	0.0	Off	
17	Off			0	0.0	0.0	0	0	0	0	0.0	Off	
18	Off			0	0.0	0.0	0	0	0	0	0.0	Off	
19	Off			0	0.0	0.0	0	0	0	0	0.0	Off	
20	Off			0	0.0	0.0	0	0	0	0	0.0	Off	
21	Off			0	0.0	0.0	0	0	0	0	0.0	Off	
22	Off			0	0.0	0.0	0	0	0	0	0.0	Off	
23	Off			0	0.0	0.0	0	0	0	0	0.0	Off	
24	Off			0	0.0	0.0	0	0	0	0	0.0	Off	
25	Off			0	0.0	0.0	0	0	0	0	0.0	Off	
26	Off			0	0.0	0.0	0	0	0	0	0.0	Off	
27	Off			0	0.0	0.0	0	0	0	0	0.0	Off	
28	Off			0	0.0	0.0	0	0	0	0	0.0	Off	
29	Off			0	0.0	0.0	0	0	0	0	0.0	Off	
30	Off			0	0.0	0.0	0	0	0	0	0.0	Off	
31	Off			0	0.0	0.0	0	0	0	0	0.0	Off	
32	Off			0	0.0	0.0	0	0	0	0	0.0	Off	

Coordination Parameters

Operational Mode	Correction Mode	Maximum Mode	Force Mode
Automatic	Shortway (Auto)	Per Pattern	Per Pattern

Patterns

Patt.	Cycle	Offset 1	Offset 2	Offset 3	Split	Sequence	Ref. Color	Max Mode	Phs	Det	Ped
									Pln	Pln	Pln
1	120	35	0	0	1	1	Yel	Inh	1	1	1
2	90	75	0	0	2	2	Yel	Inh	1	1	1
3	120	106	0	0	3	3	Yel	Inh	1	1	1
4	100	80	0	0	4	4	Yel	Inh	1	1	1
5	0	0	0	0	0	0	Yel	Inh	1	1	1
6	0	0	0	0	0	0	Yel	Inh	1	1	1
7	0	0	0	0	0	0	Yel	Inh	1	1	1
8	0	0	0	0	0	0	Yel	Inh	1	1	1
9	0	0	0	0	0	0	Yel	Inh	1	1	1
10	0	0	0	0	0	0	Yel	Inh	1	1	1
11	0	0	0	0	0	0	Yel	Inh	1	1	1
12	0	0	0	0	0	0	Yel	Inh	1	1	1
13	0	0	0	0	0	0	Yel	Inh	1	1	1
14	0	0	0	0	0	0	Yel	Inh	1	1	1
15	0	0	0	0	0	0	Yel	Inh	1	1	1
16	0	0	0	0	0	0	Yel	Inh	1	1	1

17	0	0	0	0	0	0	Yel	Inh	1	1	1
18	0	0	0	0	0	0	Yel	Inh	1	1	1
19	0	0	0	0	0	0	Yel	Inh	1	1	1
20	0	0	0	0	20	20	Yel	Max1	1	1	1
21	0	0	0	0	0	0	Yel	Inh	1	1	1
22	0	0	0	0	0	0	Yel	Inh	1	1	1
23	0	0	0	0	0	0	Yel	Inh	1	1	1
24	0	0	0	0	0	0	Yel	Inh	1	1	1
25	0	0	0	0	0	0	Yel	Inh	1	1	1
26	0	0	0	0	0	0	Yel	Inh	1	1	1
27	0	0	0	0	0	0	Yel	Inh	1	1	1
28	0	0	0	0	0	0	Yel	Inh	1	1	1
29	0	0	0	0	0	0	Yel	Inh	1	1	1
30	0	0	0	0	0	0	Yel	Inh	1	1	1
31	0	0	0	0	0	0	Yel	Inh	1	1	1
32	0	0	0	0	0	0	Yel	Inh	1	1	1
33	0	0	0	0	0	0	Yel	Inh	1	1	1
34	0	0	0	0	0	0	Yel	Inh	1	1	1
35	0	0	0	0	0	0	Yel	Inh	1	1	1
36	0	0	0	0	0	0	Yel	Inh	1	1	1
37	0	0	0	0	0	0	Yel	Inh	1	1	1
38	0	0	0	0	0	0	Yel	Inh	1	1	1
39	0	0	0	0	0	0	Yel	Inh	1	1	1
40	0	0	0	0	0	0	Yel	Inh	1	1	1
41	0	0	0	0	0	0	Yel	Inh	1	1	1
42	0	0	0	0	0	0	Yel	Inh	1	1	1
43	0	0	0	0	0	0	Yel	Inh	1	1	1
44	0	0	0	0	0	0	Yel	Inh	1	1	1
45	0	0	0	0	0	0	Yel	Inh	1	1	1
46	0	0	0	0	0	0	Yel	Inh	1	1	1
47	0	0	0	0	0	0	Yel	Inh	1	1	1
48	0	0	0	0	0	0	Yel	Inh	1	1	1
49	0	0	0	0	0	0	Yel	Inh	1	1	1
50	0	0	0	0	0	0	Yel	Inh	1	1	1
51	0	0	0	0	0	0	Yel	Inh	1	1	1
52	0	0	0	0	0	0	Yel	Inh	1	1	1
53	0	0	0	0	0	0	Yel	Inh	1	1	1
54	0	0	0	0	0	0	Yel	Inh	1	1	1
55	0	0	0	0	0	0	Yel	Inh	1	1	1
56	0	0	0	0	0	0	Yel	Inh	1	1	1
57	0	0	0	0	0	0	Yel	Inh	1	1	1
58	0	0	0	0	0	0	Yel	Inh	1	1	1
59	0	0	0	0	0	0	Yel	Inh	1	1	1
60	0	0	0	0	0	0	Yel	Inh	1	1	1
61	0	0	0	0	0	0	Yel	Inh	1	1	1
62	0	0	0	0	0	0	Yel	Inh	1	1	1
63	0	0	0	0	0	0	Yel	Inh	1	1	1
64	0	0	0	0	0	0	Yel	Inh	1	1	1
65	0	0	0	0	0	0	Yel	Inh	1	1	1
66	0	0	0	0	0	0	Yel	Inh	1	1	1
67	0	0	0	0	0	0	Yel	Inh	1	1	1
68	0	0	0	0	0	0	Yel	Inh	1	1	1
69	0	0	0	0	0	0	Yel	Inh	1	1	1
70	0	0	0	0	0	0	Yel	Inh	1	1	1
71	0	0	0	0	0	0	Yel	Inh	1	1	1
72	0	0	0	0	0	0	Yel	Inh	1	1	1
73	0	0	0	0	0	0	Yel	Inh	1	1	1
74	0	0	0	0	0	0	Yel	Inh	1	1	1
75	0	0	0	0	0	0	Yel	Inh	1	1	1
76	0	0	0	0	0	0	Yel	Inh	1	1	1
77	0	0	0	0	0	0	Yel	Inh	1	1	1
78	0	0	0	0	0	0	Yel	Inh	1	1	1
79	0	0	0	0	0	0	Yel	Inh	1	1	1

80	0	0	0	0	0	0	Yel	Inh	1	1	1
81	0	0	0	0	0	0	Yel	Inh	1	1	1
82	0	0	0	0	0	0	Yel	Inh	1	1	1
83	0	0	0	0	0	0	Yel	Inh	1	1	1
84	0	0	0	0	0	0	Yel	Inh	1	1	1
85	0	0	0	0	0	0	Yel	Inh	1	1	1
86	0	0	0	0	0	0	Yel	Inh	1	1	1
87	0	0	0	0	0	0	Yel	Inh	1	1	1
88	0	0	0	0	0	0	Yel	Inh	1	1	1
89	0	0	0	0	0	0	Yel	Inh	1	1	1
90	0	0	0	0	0	0	Yel	Inh	1	1	1
91	0	0	0	0	0	0	Yel	Inh	1	1	1
92	0	0	0	0	0	0	Yel	Inh	1	1	1
93	0	0	0	0	0	0	Yel	Inh	1	1	1
94	0	0	0	0	0	0	Yel	Inh	1	1	1
95	0	0	0	0	0	0	Yel	Inh	1	1	1
96	0	0	0	0	0	0	Yel	Inh	1	1	1
97	0	0	0	0	0	0	Yel	Inh	1	1	1
98	0	0	0	0	0	0	Yel	Inh	1	1	1
99	0	0	0	0	0	0	Yel	Inh	1	1	1
100	0	0	0	0	0	0	Yel	Inh	1	1	1
101	0	0	0	0	0	0	Yel	Inh	1	1	1
102	0	0	0	0	0	0	Yel	Inh	1	1	1
103	0	0	0	0	0	0	Yel	Inh	1	1	1
104	0	0	0	0	0	0	Yel	Inh	1	1	1
105	0	0	0	0	0	0	Yel	Inh	1	1	1
106	0	0	0	0	0	0	Yel	Inh	1	1	1
107	0	0	0	0	0	0	Yel	Inh	1	1	1
108	0	0	0	0	0	0	Yel	Inh	1	1	1
109	0	0	0	0	0	0	Yel	Inh	1	1	1
110	0	0	0	0	0	0	Yel	Inh	1	1	1
111	0	0	0	0	0	0	Yel	Inh	1	1	1
112	0	0	0	0	0	0	Yel	Inh	1	1	1
113	0	0	0	0	0	0	Yel	Inh	1	1	1
114	0	0	0	0	0	0	Yel	Inh	1	1	1
115	0	0	0	0	0	0	Yel	Inh	1	1	1
116	0	0	0	0	0	0	Yel	Inh	1	1	1
117	0	0	0	0	0	0	Yel	Inh	1	1	1
118	0	0	0	0	0	0	Yel	Inh	1	1	1
119	0	0	0	0	0	0	Yel	Inh	1	1	1
120	0	0	0	0	0	0	Yel	Inh	1	1	1
121	0	0	0	0	0	0	Yel	Inh	1	1	1
122	0	0	0	0	0	0	Yel	Inh	1	1	1
123	0	0	0	0	0	0	Yel	Inh	1	1	1
124	0	0	0	0	0	0	Yel	Inh	1	1	1
125	0	0	0	0	0	0	Yel	Inh	1	1	1
126	0	0	0	0	0	0	Yel	Inh	1	1	1
127	0	0	0	0	0	0	Yel	Inh	1	1	1
128	0	0	0	0	0	0	Yel	Inh	1	1	1

Split Parameters

Split 1		Coord	Ref	
PH.	Time	PH	PH	Mode
1	0			None
2	89	X	X	None
3	0			None
4	31			None
5	0			None
6	89	X	X	None
7	0			None
8	0			None
9	0			None
10	0			None
11	0			None

Split 2		Coord	Ref	
PH.	Time	PH	PH	Mode
1	0			None
2	61	X	X	None
3	0			None
4	29			None
5	0			None
6	61	X	X	None
7	0			None
8	0			None
9	0			None
10	0			None
11	0			None

12	0			None
13	0			None
14	0			None
15	0			None
16	0			None

12	0			None
13	0			None
14	0			None
15	0			None
16	0			None

Split 3

PH.	Time	Coord PH	Ref PH	Mode
1	0			None
2	85	X	X	None
3	0			None
4	35			None
5	0			None
6	85	X	X	None
7	0			None
8	0			None
9	0			None
10	0			None
11	0			None
12	0			None
13	0			None
14	0			None
15	0			None
16	0			None

Split 4

PH.	Time	Coord PH	Ref PH	Mode
1	0			None
2	68	X	X	None
3	0			None
4	32			None
5	0			None
6	68	X	X	None
7	0			None
8	0			None
9	0			None
10	0			None
11	0			None
12	0			None
13	0			None
14	0			None
15	0			None
16	0			None

Split 5

PH.	Time	Coord PH	Ref PH	Mode
1	0			None
2	0			None
3	0			None
4	0			None
5	0			None
6	0			None
7	0			None
8	0			None
9	0			None
10	0			None
11	0			None
12	0			None
13	0			None
14	0			None
15	0			None
16	0			None

Split 6

PH.	Time	Coord PH	Ref PH	Mode
1	0			None
2	0			None
3	0			None
4	0			None
5	0			None
6	0			None
7	0			None
8	0			None
9	0			None
10	0			None
11	0			None
12	0			None
13	0			None
14	0			None
15	0			None
16	0			None

Split 7

PH.	Time	Coord PH	Ref PH	Mode
1	0			None
2	0			None
3	0			None
4	0			None
5	0			None
6	0			None
7	0			None
8	0			None
9	0			None
10	0			None
11	0			None
12	0			None
13	0			None
14	0			None
15	0			None
16	0			None

Split 8

PH.	Time	Coord PH	Ref PH	Mode
1	0			None
2	0			None
3	0			None
4	0			None
5	0			None
6	0			None
7	0			None
8	0			None
9	0			None
10	0			None
11	0			None
12	0			None
13	0			None
14	0			None
15	0			None
16	0			None

Split 9

Split 10

PH.	Time	Coord PH	Ref PH	Mode
1	0			None
2	0			None
3	0			None
4	0			None
5	0			None
6	0			None
7	0			None
8	0			None
9	0			None

PH.	Time	Coord PH	Ref PH	Mode
1	0			None
2	0			None
3	0			None
4	0			None
5	0			None
6	0			None
7	0			None
8	0			None
9	0			None

Split 9

PH.	Time	Coord PH	Ref PH	Mode
10	0			None
11	0			None
12	0			None
13	0			None
14	0			None
15	0			None
16	0			None

Split 10

PH.	Time	Coord PH	Ref PH	Mode
10	0			None
11	0			None
12	0			None
13	0			None
14	0			None
15	0			None
16	0			None

Split 11

PH.	Time	Coord PH	Ref PH	Mode
1	0			None
2	0			None
3	0			None
4	0			None
5	0			None
6	0			None
7	0			None
8	0			None
9	0			None
10	0			None
11	0			None
12	0			None
13	0			None
14	0			None
15	0			None
16	0			None

Split 12

PH.	Time	Coord PH	Ref PH	Mode
1	0			None
2	0			None
3	0			None
4	0			None
5	0			None
6	0			None
7	0			None
8	0			None
9	0			None
10	0			None
11	0			None
12	0			None
13	0			None
14	0			None
15	0			None
16	0			None

Split 13

PH.	Time	Coord PH	Ref PH	Mode
1	0			None
2	0			None
3	0			None
4	0			None
5	0			None
6	0			None
7	0			None
8	0			None
9	0			None
10	0			None
11	0			None
12	0			None
13	0			None
14	0			None
15	0			None
16	0			None

Split 14

PH.	Time	Coord PH	Ref PH	Mode
1	0			None
2	0			None
3	0			None
4	0			None
5	0			None
6	0			None
7	0			None
8	0			None
9	0			None
10	0			None
11	0			None
12	0			None
13	0			None
14	0			None
15	0			None
16	0			None

Split 15

PH.	Time	Coord PH	Ref PH	Mode
1	0			None
2	0			None

Split 16

PH.	Time	Coord PH	Ref PH	Mode
1	0			None
2	0			None

3	0			None
4	0			None
5	0			None
6	0			None
7	0			None
8	0			None
9	0			None
10	0			None
11	0			None
12	0			None
13	0			None
14	0			None
15	0			None
16	0			None

3	0			None
4	0			None
5	0			None
6	0			None
7	0			None
8	0			None
9	0			None
10	0			None
11	0			None
12	0			None
13	0			None
14	0			None
15	0			None
16	0			None

Split 17		Coord	Ref	
PH.	Time	PH	PH	Mode
1	0			None
2	0			None
3	0			None
4	0			None
5	0			None
6	0			None
7	0			None
8	0			None
9	0			None
10	0			None
11	0			None
12	0			None
13	0			None
14	0			None
15	0			None
16	0			None

Split 18		Coord	Ref	
PH.	Time	PH	PH	Mode
1	0			None
2	0			None
3	0			None
4	0			None
5	0			None
6	0			None
7	0			None
8	0			None
9	0			None
10	0			None
11	0			None
12	0			None
13	0			None
14	0			None
15	0			None
16	0			None

Split 19		Coord	Ref	
PH.	Time	PH	PH	Mode
1	0			None
2	0			None
3	0			None
4	0			None
5	0			None
6	0			None

Split 20		Coord	Ref	
PH.	Time	PH	PH	Mode
1	0			None
2	0			None
3	0			None
4	0			None
5	0			None
6	0			None

Split 19		Coord	Ref	
PH.	Time	PH	PH	Mode
7	0			None
8	0			None
9	0			None
10	0			None
11	0			None
12	0			None
13	0			None
14	0			None
15	0			None
16	0			None

Split 20		Coord	Ref	
PH.	Time	PH	PH	Mode
7	0			None
8	0			None
9	0			None
10	0			None
11	0			None
12	0			None
13	0			None
14	0			None
15	0			None
16	0			None

Ring	1	2	3	4	5	6	7	8	9	10	11	12	13	14	15	16
Offset																

Day Plan	1																											
Month of Year	Days of Week				Days of Month																							
J	F	M	A	M	J	S	M	T	W	T	F	S	1	2	3	4	5	6	7	8	9	10	11	12	13	14	15	16

X	X	X	X	X	X	X	X	X	X	X	X	X	X	X	X	X	X	X	X	X	X	X
J	A	S	O	N	D																	
X	X	X	X	X	X																	

Day Plan 2

Month of Year	Days of Week	Days of Month																												
J	F	M	A	M	J	S	M	T	W	T	F	S	1	2	3	4	5	6	7	8	9	10	11	12	13	14	15	16		
X	X	X	X	X	X	X						X	X	X	X	X	X	X	X	X	X	X	X	X	X	X	X	X	X	
J	A	S	O	N	D								17	18	19	20	21	22	23	24	25	26	27	28	29	30	31			
X	X	X	X	X	X								X	X	X	X	X	X	X	X	X	X	X	X	X	X	X	X	X	

Day Plan 3

Month of Year	Days of Week	Days of Month																												
J	F	M	A	M	J	S	M	T	W	T	F	S	1	2	3	4	5	6	7	8	9	10	11	12	13	14	15	16		
X	X	X	X	X	X	X	X	X	X	X	X	X	X	X	X	X	X	X	X	X	X	X	X	X	X	X	X	X	X	
J	A	S	O	N	D								17	18	19	20	21	22	23	24	25	26	27	28	29	30	31			
X	X	X	X	X	X								X	X	X	X	X	X	X	X	X	X	X	X	X	X	X	X	X	

Day Plan 4

Month of Year	Days of Week	Days of Month																												
J	F	M	A	M	J	S	M	T	W	T	F	S	1	2	3	4	5	6	7	8	9	10	11	12	13	14	15	16		
					X							X	X	X	X	X	X	X	X	X	X	X	X	X	X	X	X	X	X	
J	A	S	O	N	D								17	18	19	20	21	22	23	24	25	26	27	28	29	30	31			
				X									X	X	X	X	X	X	X	X	X	X	X	X	X	X	X	X	X	

Day Plan 5

Month of Year	Days of Week	Days of Month																												
J	F	M	A	M	J	S	M	T	W	T	F	S	1	2	3	4	5	6	7	8	9	10	11	12	13	14	15	16		
											X																			
J	A	S	O	N	D								17	18	19	20	21	22	23	24	25	26	27	28	29	30	31			
				X																		X								

Day Plan 6

Month of Year	Days of Week	Days of Month																												
J	F	M	A	M	J	S	M	T	W	T	F	S	1	2	3	4	5	6	7	8	9	10	11	12	13	14	15	16		
											X																			
J	A	S	O	N	D								17	18	19	20	21	22	23	24	25	26	27	28	29	30	31			
				X																		X								

Day Plan 7

Month of Year	Days of Week	Days of Month																												
J	F	M	A	M	J	S	M	T	W	T	F	S	1	2	3	4	5	6	7	8	9	10	11	12	13	14	15	16		
X	X	X	X	X	X	X	X	X	X	X	X	X	X	X	X	X	X	X	X	X	X	X	X	X	X	X	X	X	X	
J	A	S	O	N	D								17	18	19	20	21	22	23	24	25	26	27	28	29	30	31			
X	X	X	X	X	X								X	X	X	X	X	X	X	X	X	X	X	X	X	X	X	X	X	

Day Plan 8

Month of Year	Days of Week	Days of Month																												
J	F	M	A	M	J	S	M	T	W	T	F	S	1	2	3	4	5	6	7	8	9	10	11	12	13	14	15	16		
X	X	X	X	X	X	X	X	X	X	X	X	X	X	X	X	X	X	X	X	X	X	X	X	X	X	X	X	X	X	
J	A	S	O	N	D								17	18	19	20	21	22	23	24	25	26	27	28	29	30	31			
X	X	X	X	X	X								X	X	X	X	X	X	X	X	X	X	X	X	X	X	X	X	X	

Day Plan 9

Month of Year	Days of Week	Days of Month																												
J	F	M	A	M	J	S	M	T	W	T	F	S	1	2	3	4	5	6	7	8	9	10	11	12	13	14	15	16		
X	X	X	X	X	X	X	X	X	X	X	X	X	X	X	X	X	X	X	X	X	X	X	X	X	X	X	X	X	X	
J	A	S	O	N	D								17	18	19	20	21	22	23	24	25	26	27	28	29	30	31			
X	X	X	X	X	X								X	X	X	X	X	X	X	X	X	X	X	X	X	X	X	X	X	

Day Plan 10

Month of Year	Days of Week	Days of Month																												
J	F	M	A	M	J	S	M	T	W	T	F	S	1	2	3	4	5	6	7	8	9	10	11	12	13	14	15	16		
X	X	X	X	X	X	X	X	X	X	X	X	X	X	X	X	X	X	X	X	X	X	X	X	X	X	X	X	X	X	
J	A	S	O	N	D								17	18	19	20	21	22	23	24	25	26	27	28	29	30	31			
X	X	X	X	X	X								X	X	X	X	X	X	X	X	X	X	X	X	X	X	X	X	X	

J	A	S	O	N	D
X	X	X	X	X	X

17	18	19	20	21	22	23	24	25	26	27	28	29	30	31
X	X	X	X	X	X	X	X	X	X	X	X	X	X	X

Day Plan 11

Month of Year							Days of Week							Days of Month															
J	F	M	A	M	J	S	M	T	W	T	F	S	1	2	3	4	5	6	7	8	9	10	11	12	13	14	15	16	
J	A	S	O	N	D								17	18	19	20	21	22	23	24	25	26	27	28	29	30	31		

Day Plan 12

Month of Year							Days of Week							Days of Month															
J	F	M	A	M	J	S	M	T	W	T	F	S	1	2	3	4	5	6	7	8	9	10	11	12	13	14	15	16	
J	A	S	O	N	D								17	18	19	20	21	22	23	24	25	26	27	28	29	30	31		

Day Plan 13

Month of Year							Days of Week							Days of Month															
J	F	M	A	M	J	S	M	T	W	T	F	S	1	2	3	4	5	6	7	8	9	10	11	12	13	14	15	16	
J	A	S	O	N	D								17	18	19	20	21	22	23	24	25	26	27	28	29	30	31		

Day Plan 14

Month of Year							Days of Week							Days of Month															
J	F	M	A	M	J	S	M	T	W	T	F	S	1	2	3	4	5	6	7	8	9	10	11	12	13	14	15	16	
J	A	S	O	N	D								17	18	19	20	21	22	23	24	25	26	27	28	29	30	31		

Day Plan 15

Month of Year							Days of Week							Days of Month															
J	F	M	A	M	J	S	M	T	W	T	F	S	1	2	3	4	5	6	7	8	9	10	11	12	13	14	15	16	
J	A	S	O	N	D								17	18	19	20	21	22	23	24	25	26	27	28	29	30	31		

Day Plan 1

Event	Hour	Min.	Act
1	6	0	1
2	9	0	2
3	15	0	3
4	19	0	2
5	22	0	20

Day Plan 2

Event	Hour	Min.	Act
1	9	0	4
2	22	0	20
3	0	0	
4	0	0	
5	0	0	

Day Plan 3

Event	Hour	Min.	Act
1	0	0	
2	0	0	
3	0	0	
4	0	0	
5	0	0	

Day Plan 4

Event	Hour	Min.	Act
1	9	0	4
2	21	0	20
3	0	0	
4	0	0	
5	0	0	

Day Plan 1

Event	Hour	Min.	Act
6	0	0	
7	0	0	
8	0	0	
9	0	0	
10	0	0	

Day Plan 2

Event	Hour	Min.	Act
6	0	0	
7	0	0	
8	0	0	
9	0	0	
10	0	0	

Day Plan 3

Event	Hour	Min.	Act
6	0	0	
7	0	0	
8	0	0	
9	0	0	
10	0	0	

Day Plan 4

Event	Hour	Min.	Act
6	0	0	
7	0	0	
8	0	0	
9	0	0	
10	0	0	

Day Plan 5

Event	Hour	Min.	Act
1	6	0	1
2	8	0	2
3	15	0	3
4	19	0	4
5	0	0	
6	0	0	

Day Plan 6

Event	Hour	Min.	Act
1	0	1	4
2	22	0	20
3	0	0	
4	0	0	
5	0	0	
6	0	0	

Day Plan 7

Event	Hour	Min.	Act
1	0	0	
2	0	0	
3	0	0	
4	0	0	
5	0	0	
6	0	0	

Day Plan 8

Event	Hour	Min.	Act
1	0	0	
2	0	0	
3	0	0	
4	0	0	
5	0	0	
6	0	0	

7	0	0	
8	0	0	
9	0	0	
10	0	0	

7	0	0	
8	0	0	
9	0	0	
10	0	0	

7	0	0	
8	0	0	
9	0	0	
10	0	0	

7	0	0	
8	0	0	
9	0	0	
10	0	0	

Day Plan 9

Day Plan 10

Day Plan 11

Day Plan 12

Event	Hour	Min.	Act
1	0	0	
2	0	0	
3	0	0	
4	0	0	
5	0	0	
6	0	0	
7	0	0	
8	0	0	
9	0	0	
10	0	0	

Event	Hour	Min.	Act
1	0	0	
2	0	0	
3	0	0	
4	0	0	
5	0	0	
6	0	0	
7	0	0	
8	0	0	
9	0	0	
10	0	0	

Event	Hour	Min.	Act
1	0	0	
2	0	0	
3	0	0	
4	0	0	
5	0	0	
6	0	0	
7	0	0	
8	0	0	
9	0	0	
10	0	0	

Event	Hour	Min.	Act
1	0	0	
2	0	0	
3	0	0	
4	0	0	
5	0	0	
6	0	0	
7	0	0	
8	0	0	
9	0	0	
10	0	0	

Day Plan 13

Day Plan 14

Day Plan 15

Day Plan 16

Event	Hour	Min.	Act
1	0	0	
2	0	0	
3	0	0	
4	0	0	
5	0	0	
6	0	0	
7	0	0	
8	0	0	
9	0	0	
10	0	0	

Event	Hour	Min.	Act
1	0	0	
2	0	0	
3	0	0	
4	0	0	
5	0	0	
6	0	0	
7	0	0	
8	0	0	
9	0	0	
10	0	0	

Event	Hour	Min.	Act
1	0	0	
2	0	0	
3	0	0	
4	0	0	
5	0	0	
6	0	0	
7	0	0	
8	0	0	
9	0	0	
10	0	0	

Event	Hour	Min.	Act
1	0	0	
2	0	0	
3	0	0	
4	0	0	
5	0	0	
6	0	0	
7	0	0	
8	0	0	
9	0	0	
10	0	0	

Day Plan 17

Day Plan 18

Day Plan 19

Day Plan 20

Event	Hour	Min.	Act
1	0	0	
2	0	0	
3	0	0	
4	0	0	
5	0	0	
6	0	0	
7	0	0	
8	0	0	
9	0	0	
10	0	0	

Event	Hour	Min.	Act
1	0	0	
2	0	0	
3	0	0	
4	0	0	
5	0	0	
6	0	0	
7	0	0	
8	0	0	
9	0	0	
10	0	0	

Event	Hour	Min.	Act
1	0	0	
2	0	0	
3	0	0	
4	0	0	
5	0	0	
6	0	0	
7	0	0	
8	0	0	
9	0	0	
10	0	0	

Event	Hour	Min.	Act
1	0	0	
2	0	0	
3	0	0	
4	0	0	
5	0	0	
6	0	0	
7	0	0	
8	0	0	
9	0	0	
10	0	0	

Actions

Act	Pattern	Aux.			Special Functions									
		1	2	3	1	2	3	4	5	6	7	8		
1	Pattern 1													
2	Pattern 2													
3	Pattern 3													
4	Pattern 4													
5	Pattern 5													
6	Pattern 6													
7	Pattern 7													
8	Pattern 8													
9	Pattern 9													
10	Pattern 10													
11	None													
12	None													
13	None													
14	None													
15	None													
16	None													
17	None													
18	None													
19	None													

Actions

Act	Pattern	Aux.			Special Functions									
		1	2	3	1	2	3	4	5	6	7	8		
33	None													
34	None													
35	None													
36	None													
37	None													
38	None													
39	None													
40	None													
41	None													
42	None													
43	None													
44	None													
45	None													
46	None													
47	None													
48	None													
49	None													
50	None													
51	None													

20	Pattern 20																		
21	None																		
22	None																		
23	None																		
24	None																		
25	None																		
26	None																		
27	None																		
28	None																		
29	None																		
30	None																		
31	None																		
32	None																		

52	None																		
53	None																		
54	None																		
55	None																		
56	None																		
57	None																		
58	None																		
59	None																		
60	None																		
61	None																		
62	None																		
63	None																		
64	None																		

Preemption Parameters

Preempt	1	2	3	4	5	6	7	8
Link	0	0	0	0	0	0	0	0
Delay	0	0	0	0	0	0	0	0
Min Duration	0	0	0	0	0	0	0	0
Min Green	0	0	0	0	0	0	0	0
Min Walk	0	0	0	0	0	0	0	0
Ent. Ped Clear	255	255	255	255	255	255	255	255
Track Green	0	0	0	0	0	0	0	0
Dwell Green	0	0	0	0	0	0	0	0
Max Presence	0	0	0	0	0	0	0	0
Enter Yellow	25.5	25.5	25.5	25.5	25.5	25.5	25.5	25.5
Ent. Red Clear	25.5	25.5	25.5	25.5	25.5	25.5	25.5	25.5

Preemption Parameters

Preempt	1	2	3	4	5	6	7	8
Track Yellow	25.5	25.5	25.5	25.5	25.5	25.5	25.5	25.5
Track Red Clear	25.5	25.5	25.5	25.5	25.5	25.5	25.5	25.5
Exit Red	25.5	25.5	25.5	25.5	25.5	25.5	25.5	25.5
Exit Ped Clear	255	255	255	255	255	255	255	255
Exit Yellow	25.5	25.5	25.5	25.5	25.5	25.5	25.5	25.5
Exit Red	25.5	25.5	25.5	25.5	25.5	25.5	25.5	25.5
Preempt	1	2	3	4	5	6	7	8
Non Lock Mem								
Not Override Flash								
NotOverrideNextPre								
Flash Dwell								

Preemption Configuration

Preempt	1	2	3	4	5	6	7	8
Track phase								
Dwell Phase			2,5	4,7	1,6	3,8		
Dwell Ped								
Exit Phase								
Track Overlap								
Dwell overlap								
Cycling phase								
Cycling Ped								
Cycling Overlap								

IO Modules

IO Mod	TYPE
1	Caltrans 332
2	None
3	None
4	None
5	None
6	None
7	None
8	None
9	None
10	None

Channel Configuration

Chan	Ctrl Type	Source
1	Phs Veh	1
2	Phs Veh	2
3	Phs Veh	3
4	Phs Veh	4
5	Phs Veh	5
6	Phs Veh	6
7	Phs Veh	7
8	Phs Veh	8
9	Olp	1
10	Olp	2

Chan	Ctrl Type	Source
11	Olp	3
12	Olp	4
13	Phs Ped	2
14	Phs Ped	4
15	Phs Ped	6
16	Phs Ped	8
17	Olp	5
18	Olp	6
19	None	0
20	None	0

Channel Options

Channel	1	2	3	4	5	6	7	8	9	10	11	12	13	14	15	16
Flash Yellow																
Flash Red	X	X	X	X	X	X	X	X								
Alt Flash	X			X	X			X								
Channel	17	18	19	20	21	22	23	24	25	26	27	28	29	30	31	32
Flash Yellow																
Flash Red																
Alt Flash																

Startup Clearance Hold Type

1=off, 2=On, 3=Flash and 4= Alt Flash

Channel	1	2	3	4	5	6	7	8	9	10	11	12	13	14	15	16
Red																
Yellow																
Green																
Channel	17	18	19	20	21	22	23	24	25	26	27	28	29	30	31	32
Red																
Yellow																
Green																

Phase Intervals

Interval	Description	Red	Yel	Grn	Type
1	notActive	On	Off	Off	Red
2	dltGrn	On	Off	Off	Red
3	PreGrn	Off	Off	On	Green
4	minGrn	Off	Off	On	Green
5	grnExt	Off	Off	On	Green
6	grnDwell	Off	Off	On	Green
7	preClear	Off	Off	On	Green
8	yelChange	Off	On	Off	Yellow
9	redClear	On	Off	Off	Red
10	redDwell	On	Off	Off	Red
11	Barrier	On	Off	Off	Red
12					

Pedestrian Intervals

Interval	Description	DWK	CLR	Wlk	Type
1	notActive	On	Off	Off	Dont Walk
2	dltPed	On	Off	Off	Dont Walk
3	walk	Off	Off	On	Walk
4	walkDwell	Off	Off	On	Walk
5	flashDtWlk	Flash	Off	Off	Ped Clear
6	dWalk	On	Off	Off	Dont Walk
7					
8					

Countdown Display

Display	Addr	Phase	Time
1			
2			
3			
4			
5			
6			
7			
8			

Display	Addr	Phase	Time
9			
10			
11			
12			
13			
14			
15			
16			

Display	Addr	Phase	Time
17			
18			
19			
20			
21			
22			
23			
24			

Display	Addr	Phase	Time
25			
26			
27			
28			
29			
30			
31			
32			

Manual Control Phase Groups

Grp 1	Grp 2	Grp 3	Grp 4	Grp 5	Grp 6	Grp 7	Grp 8
Ring	Ph	Ring	Ph	Ring	Ph	Ring	Ph
1	0	1	0	1	0	1	0
2	0	2	0	2	0	2	0
3	0	3	0	3	0	3	0
4	0	4	0	4	0	4	0
5	0	5	0	5	0	5	0
6	0	6	0	6	0	6	0
7	0	7	0	7	0	7	0
8	0	8	0	8	0	8	0
9	0	9	0	9	0	9	0
10	0	10	0	10	0	10	0
11	0	11	0	11	0	11	0
12	0	12	0	12	0	12	0
13	0	13	0	13	0	13	0
14	0	14	0	14	0	14	0
15	0	15	0	15	0	15	0
16	0	16	0	16	0	16	0

Prioritor Settings

Prioritor	Priority Ph	Output Dly
1		0
2		0
3		0
4		0
5		0

Enabled	Lock Out Time
No	0

6		0
7		0
8		0

Loopback Functions

Func	Result Function Type	Index	Source Function Type	Index	Func	Result Function Type	Index	Source Function Type	Index
1					51				
2					52				
3					53				
4					54				
5					55				
6					56				
7					57				
8					58				
9					59				
10					60				
11					61				
12					62				
13					63				
14					64				
15					65				
16					66				
17					67				
18					68				
19					69				
20					70				
21					71				
22					72				
23					73				
24					74				
25					75				
26					76				
27					77				
28					78				
29					79				
30					80				
31					81				
32					82				
33					83				
34					84				
35					85				
36					86				
37					87				
38					88				
39					89				
40					90				
41					91				
42					92				
43					93				
44					94				
45					95				
46					96				
47					97				
48					98				
49					99				
50					100				

Peer Configuration

Ctrl	Peer ID	IP address	SNMP Port	Hot Port	Serial Port	Serial Addr.	Master Sect.	P2P TO	Description
1	0		161	80	0	0	0	15	
2	0		161	80	0	0	0	15	
3	0		161	80	0	0	0	15	

4	0		161	80	0	0	0	15	
5	0		161	80	0	0	0	15	
6	0		161	80	0	0	0	15	
7	0		161	80	0	0	0	15	
8	0		161	80	0	0	0	15	
9	0		161	80	0	0	0	15	
10	0		161	80	0	0	0	15	
11	0		161	80	0	0	0	15	
12	0		161	80	0	0	0	15	
13	0		161	80	0	0	0	15	
14	0		161	80	0	0	0	15	
15	0		161	80	0	0	0	15	
16	0		161	80	0	0	0	15	
17	0		161	80	0	0	0	15	
18	0		161	80	0	0	0	15	
19	0		161	80	0	0	0	15	
20	0		161	80	0	0	0	15	
21	0		161	80	0	0	0	15	
22	0		161	80	0	0	0	15	
23	0		161	80	0	0	0	15	
24	0		161	80	0	0	0	15	
25	0		161	80	0	0	0	15	
26	0		161	80	0	0	0	15	
27	0		161	80	0	0	0	15	
28	0		161	80	0	0	0	15	
29	0		161	80	0	0	0	15	
30	0		161	80	0	0	0	15	
31	0		161	80	0	0	0	15	
32	0		161	80	0	0	0	15	
33	0		161	80	0	0	0	15	
34	0		161	80	0	0	0	15	
35	0		161	80	0	0	0	15	
36	0		161	80	0	0	0	15	
37	0		161	80	0	0	0	15	
38	0		161	80	0	0	0	15	
39	0		161	80	0	0	0	15	
40	0		161	80	0	0	0	15	
41	0		161	80	0	0	0	15	
42	0		161	80	0	0	0	15	
43	0		161	80	0	0	0	15	
44	0		161	80	0	0	0	15	
45	0		161	80	0	0	0	15	
46	0		161	80	0	0	0	15	
47	0		161	80	0	0	0	15	
48	0		161	80	0	0	0	15	
49	0		161	80	0	0	0	15	
50	0		161	80	0	0	0	15	
51	0		161	80	0	0	0	15	
52	0		161	80	0	0	0	15	
53	0		161	80	0	0	0	15	
54	0		161	80	0	0	0	15	
55	0		161	80	0	0	0	15	
56	0		161	80	0	0	0	15	
57	0		161	80	0	0	0	15	
58	0		161	80	0	0	0	15	
59	0		161	80	0	0	0	15	
60	0		161	80	0	0	0	15	
61	0		161	80	0	0	0	15	
62	0		161	80	0	0	0	15	
63	0		161	80	0	0	0	15	
64	0		161	80	0	0	0	15	
65	0		161	80	0	0	0	15	
66	0		161	80	0	0	0	15	
67	0		161	80	0	0	0	15	

68	0		161	80	0	0	0	15	
69	0		161	80	0	0	0	15	
70	0		161	80	0	0	0	15	
71	0		161	80	0	0	0	15	
72	0		161	80	0	0	0	15	
73	0		161	80	0	0	0	15	
74	0		161	80	0	0	0	15	
75	0		161	80	0	0	0	15	
76	0		161	80	0	0	0	15	
77	0		161	80	0	0	0	15	
78	0		161	80	0	0	0	15	
79	0		161	80	0	0	0	15	
80	0		161	80	0	0	0	15	
81	0		161	80	0	0	0	15	
82	0		161	80	0	0	0	15	
83	0		161	80	0	0	0	15	
84	0		161	80	0	0	0	15	
85	0		161	80	0	0	0	15	
86	0		161	80	0	0	0	15	
87	0		161	80	0	0	0	15	
88	0		161	80	0	0	0	15	
89	0		161	80	0	0	0	15	
90	0		161	80	0	0	0	15	
91	0		161	80	0	0	0	15	
92	0		161	80	0	0	0	15	
93	0		161	80	0	0	0	15	
94	0		161	80	0	0	0	15	
95	0		161	80	0	0	0	15	
96	0		161	80	0	0	0	15	
97	0		161	80	0	0	0	15	
98	0		161	80	0	0	0	15	
99	0		161	80	0	0	0	15	
100	0		161	80	0	0	0	15	
101	0		161	80	0	0	0	15	
102	0		161	80	0	0	0	15	
103	0		161	80	0	0	0	15	
104	0		161	80	0	0	0	15	
105	0		161	80	0	0	0	15	
106	0		161	80	0	0	0	15	
107	0		161	80	0	0	0	15	
108	0		161	80	0	0	0	15	
109	0		161	80	0	0	0	15	
110	0		161	80	0	0	0	15	
111	0		161	80	0	0	0	15	
112	0		161	80	0	0	0	15	
113	0		161	80	0	0	0	15	
114	0		161	80	0	0	0	15	
115	0		161	80	0	0	0	15	
116	0		161	80	0	0	0	15	
117	0		161	80	0	0	0	15	
118	0		161	80	0	0	0	15	
119	0		161	80	0	0	0	15	
120	0		161	80	0	0	0	15	
121	0		161	80	0	0	0	15	
122	0		161	80	0	0	0	15	
123	0		161	80	0	0	0	15	
124	0		161	80	0	0	0	15	
125	0		161	80	0	0	0	15	
126	0		161	80	0	0	0	15	
127	0		161	80	0	0	0	15	
128	0		161	80	0	0	0	15	
129	0		161	80	0	0	0	15	
130	0		161	80	0	0	0	15	

131	0		161	80	0	0	0	15	
132	0		161	80	0	0	0	15	
133	0		161	80	0	0	0	15	
134	0		161	80	0	0	0	15	
135	0		161	80	0	0	0	15	
136	0		161	80	0	0	0	15	
137	0		161	80	0	0	0	15	
138	0		161	80	0	0	0	15	
139	0		161	80	0	0	0	15	
140	0		161	80	0	0	0	15	
141	0		161	80	0	0	0	15	
142	0		161	80	0	0	0	15	
143	0		161	80	0	0	0	15	
144	0		161	80	0	0	0	15	
145	0		161	80	0	0	0	15	
146	0		161	80	0	0	0	15	
147	0		161	80	0	0	0	15	
148	0		161	80	0	0	0	15	
149	0		161	80	0	0	0	15	
150	0		161	80	0	0	0	15	
151	0		161	80	0	0	0	15	
152	0		161	80	0	0	0	15	
153	0		161	80	0	0	0	15	
154	0		161	80	0	0	0	15	
155	0		161	80	0	0	0	15	
156	0		161	80	0	0	0	15	
157	0		161	80	0	0	0	15	
158	0		161	80	0	0	0	15	
159	0		161	80	0	0	0	15	
160	0		161	80	0	0	0	15	
161	0		161	80	0	0	0	15	
162	0		161	80	0	0	0	15	
163	0		161	80	0	0	0	15	
164	0		161	80	0	0	0	15	
165	0		161	80	0	0	0	15	
166	0		161	80	0	0	0	15	
167	0		161	80	0	0	0	15	
168	0		161	80	0	0	0	15	
169	0		161	80	0	0	0	15	
170	0		161	80	0	0	0	15	
171	0		161	80	0	0	0	15	
172	0		161	80	0	0	0	15	
173	0		161	80	0	0	0	15	
174	0		161	80	0	0	0	15	
175	0		161	80	0	0	0	15	
176	0		161	80	0	0	0	15	
177	0		161	80	0	0	0	15	
178	0		161	80	0	0	0	15	
179	0		161	80	0	0	0	15	
180	0		161	80	0	0	0	15	
181	0		161	80	0	0	0	15	
182	0		161	80	0	0	0	15	
183	0		161	80	0	0	0	15	
184	0		161	80	0	0	0	15	
185	0		161	80	0	0	0	15	
186	0		161	80	0	0	0	15	
187	0		161	80	0	0	0	15	
188	0		161	80	0	0	0	15	
189	0		161	80	0	0	0	15	
190	0		161	80	0	0	0	15	
191	0		161	80	0	0	0	15	
192	0		161	80	0	0	0	15	
193	0		161	80	0	0	0	15	
194	0		161	80	0	0	0	15	

195	0		161	80	0	0	0	15	
196	0		161	80	0	0	0	15	
197	0		161	80	0	0	0	15	
198	0		161	80	0	0	0	15	
199	0		161	80	0	0	0	15	
200	0		161	80	0	0	0	15	
201	0		161	80	0	0	0	15	
202	0		161	80	0	0	0	15	
203	0		161	80	0	0	0	15	
204	0		161	80	0	0	0	15	
205	0		161	80	0	0	0	15	
206	0		161	80	0	0	0	15	
207	0		161	80	0	0	0	15	
208	0		161	80	0	0	0	15	
209	0		161	80	0	0	0	15	
210	0		161	80	0	0	0	15	
211	0		161	80	0	0	0	15	
212	0		161	80	0	0	0	15	
213	0		161	80	0	0	0	15	
214	0		161	80	0	0	0	15	
215	0		161	80	0	0	0	15	
216	0		161	80	0	0	0	15	
217	0		161	80	0	0	0	15	
218	0		161	80	0	0	0	15	
219	0		161	80	0	0	0	15	
220	0		161	80	0	0	0	15	
221	0		161	80	0	0	0	15	
222	0		161	80	0	0	0	15	
223	0		161	80	0	0	0	15	
224	0		161	80	0	0	0	15	
225	0		161	80	0	0	0	15	
226	0		161	80	0	0	0	15	
227	0		161	80	0	0	0	15	
228	0		161	80	0	0	0	15	
229	0		161	80	0	0	0	15	
230	0		161	80	0	0	0	15	
231	0		161	80	0	0	0	15	
232	0		161	80	0	0	0	15	
233	0		161	80	0	0	0	15	
234	0		161	80	0	0	0	15	
235	0		161	80	0	0	0	15	
236	0		161	80	0	0	0	15	
237	0		161	80	0	0	0	15	
238	0		161	80	0	0	0	15	
239	0		161	80	0	0	0	15	
240	0		161	80	0	0	0	15	
241	0		161	80	0	0	0	15	
242	0		161	80	0	0	0	15	
243	0		161	80	0	0	0	15	
244	0		161	80	0	0	0	15	
245	0		161	80	0	0	0	15	
246	0		161	80	0	0	0	15	
247	0		161	80	0	0	0	15	
248	0		161	80	0	0	0	15	
249	0		161	80	0	0	0	15	
250	0		161	80	0	0	0	15	
251	0		161	80	0	0	0	15	
252	0		161	80	0	0	0	15	
253	0		161	80	0	0	0	15	
254	0		161	80	0	0	0	15	
255	0		161	80	0	0	0	15	

Section Configuration

--	--	--	--	--	--	--	--	--	--

Section	Control	Poll	Req #	Fail Time	Algorithm Period	Description
1	None	60	1	300	240	
2	None	60	1	300	240	
3	None	60	1	300	240	
4	None	60	1	300	240	
5	None	60	1	300	240	
6	None	60	1	300	240	
7	None	60	1	300	240	
8	None	60	1	300	240	
9	None	60	1	300	240	
10	None	60	1	300	240	
11	None	60	1	300	240	
12	None	60	1	300	240	
13	None	60	1	300	240	
14	None	60	1	300	240	
15	None	60	1	300	240	
16	None	60	1	300	240	

User Program Info

Pgrm	Description
1	
2	
3	
4	
5	
6	
7	
8	
9	
10	
11	
12	
13	
14	
15	
16	
17	
18	
19	
20	
21	
22	
23	
24	
25	
26	
27	
28	
29	
30	
31	
32	

Castle Rock, CO



Solutions that Move the World™

250 - Allen Way @ Allen St - Cobalt @ 10.50.60.64 - Econolite Type - Cobalt

Configuration Controller Sequence

Phase Ring Sequence and Assignment (MM) 1-1-1

Hardware Alternate Sequence Enable: No

Phase Ring Sequence.....(Note: Sequences identical to the prior one are not printed)

	01	02	03	04	05	06	07	08	09	10	11	12	13	14	15	16
	B	B	B	B	B											
Sequence 1																
Ring 1	1	2 3	4 9	10 13	14
Ring 2	5	6 7	8 11	12 15	16
Sequence 2																
Ring 1	2	1 3	4 10	9 13	14
Ring 2	5	6 7	8 11	12 15	16
Sequence 3																
Ring 1	1	2 4	3 9	10 14	13
Ring 2	5	6 7	8 11	12 15	16
Sequence 4																
Ring 1	2	1 4	3 10	9 14	13
Ring 2	5	6 7	8 11	12 15	16
Sequence 5																
Ring 1	1	2 3	4 9	10 13	14
Ring 2	6	5 7	8 12	11 15	16
Sequence 6																
Ring 1	2	1 3	4 10	9 13	14
Ring 2	6	5 7	8 12	11 15	16
Sequence 7																
Ring 1	1	2 4	3 9	10 14	13
Ring 2	6	5 7	8 12	11 15	16
Sequence 8																
Ring 1	2	1 4	3 10	9 14	13
Ring 2	6	5 7	8 12	11 15	16
Sequence 9																
Ring 1	1	2 3	4 9	10 13	14
Ring 2	5	6 8	7 11	12 16	15
Sequence 10																
Ring 1	2	1 3	4 10	9 13	14
Ring 2	5	6 8	7 11	12 16	15
Sequence 11																
Ring 1	1	2 4	3 9	10 14	13
Ring 2	5	6 8	7 11	12 16	15
Sequence 12																
Ring 1	2	1 4	3 10	9 14	13
Ring 2	5	6 8	7 11	12 16	15
Sequence 13																
Ring 1	1	2 3	4 9	10 13	14
Ring 2	6	5 8	7 12	11 16	15
Sequence 14																
Ring 1	2	1 3	4 10	9 13	14
Ring 2	6	5 8	7 12	11 16	15
Sequence 15																
Ring 1	1	2 4	3 9	10 14	13
Ring 2	6	5 8	7 12	11 16	15
Sequence 16																
Ring 1	2	1 4	3 10	9 14	13
Ring 2	6	5 8	7 12	11 16	15

Phases In Use/Exclusive Ped (MM) 1-2

Phase	1	2	3	4	5	6	7	8	9	10	11	12	13	14	15	16
Phases In Use		X	X	X	X	X		X								
Exclusive Ped																

Phase Compatibility (MM) 1-1-2

Phase	
n/a	Barrier Mode

Phase and Overlap Descriptions

Phase	1	2	3	4	5	6	7	8	9	10	11	12	13	14	15	16
Approach	N	S	E	W	S	N	W	E	N	N	N	N	N	N	N	N
Movement	L	T	L	T	L	T	L	T								
Associated PED																
Overlap	A	B	C	D	E	F	G	H	I	J	K	L	M	N	O	P

Approach	N	N	N	N	N	N	N	N	N	N	N	N	N	N	N	N
Movement																

Administration (MM) 1-7-1

Enable Controller/Cabinet Interlock CRC No
CRC (16 bit) 34DB
Enable Automatic Backup to Datakey No

Backup Prevent (MM) 1-1-3

Phases	1	2	3	4	5	6	7	8	9	10	11	12	13	14	15	16
Timing	1
Phases	2
	3
	4
	5
	6	X
	7
	8
	9
	10
	11
	12
	13
	14
	15
	16

Simultaneous Gap (MM) 1-1-4

Phases	1	2	3	4	5	6	7	8	9	10	11	12	13	14	15	16
Phase	1
Must	2
Gap	3
With	4
Phase	5
	6
	7
	8
	9
	10
	11
	12
	13
	14
	15
	16
Disable	

Load Switch Assignments (MM) 1-3

	Phase / Overlap	Type	Dimming				Power Up	Auto		Flash Together
			Red	Yellow	Green	Dark		Red	Yellow	
1	1	V				-	Auto	X		
2	2	V				-	Auto	X		X
3	3	V				-	Auto	X		
4	4	V				-	Auto	X		X
5	5	V				+	Auto	X		
6	6	V				+	Auto	X		X
7	7	V				+	Auto	X		
8	8	V				+	Auto	X		X
9	2	P				-	Auto			
10	4	P				-	Auto			
11	6	P				+	Auto			
12	8	P				+	Auto			
13	1	O				-	Auto	X		
14	2	O				+	Auto	X		X
15	3	O				-	Auto	X		
16	4	O				+	Auto	X		X

Castle Rock, CO



Solutions that Move the World™

250 - Allen Way @ Allen St - Cobalt @ 10.50.60.64 - Econolite Type - Cobalt

Configuration Port 1 (SDLC)

Port 1 SDLC (MM) 1-4-1

BIU	1	2	3	4	5	6	7	8
Term & Facility								
Detector Rack								

Enable TS2/MMU Type Cabinet: No
 Enable MMU Extended Status: No
 Enable SDLC Stop Time: No
 Enable 3 Critical RFE's Lockup: Yes

MMU Program (MM) 1-4-2

Channel Can Serve With Channel	
Channel 1	Channel 2

Color Check Enable (MM) 1-4-3

Enable Color Check: Yes

MMU/LS	1	2	3	4	5	6	7	8	9	10	11	12	13	14	15	16
Green																
Yellow																
Red																

Secondary Stations/Tests (MM) 1-4-4

ID	1	2	3	4	5	6	7	8	MMU
Term & Facility									

ID	1	2	3	4	5	6	7	8	Diag
Detector Rack									

Enable SDLC Diagnostic Test: No

Castle Rock, CO



Solutions that Move the World™

250 - Allen Way @ Allen St - Cobalt @ 10.50.60.64 - Econolite Type - Cobalt

Configuration Communications 1 (SDLC)**Ethernet Port Configuration (MM) 1-5-1**

Controller IP: 10.50.60.64
 Subnet Mask: 255.255.255.0
 Default Gateway IP: 10.50.60.1
 Server IP: 10.1.5.39

NTCIP (MM) 1-5-5

NTCIP Backup Time (Sec): 0
 NTCIP UDP Port: 501
 Ethernet Priority: 1
 Port 2 Priority (Port C50S for 2070): 4
 Port 3A Priority (Port C21S for 2070): 3
 Port 3B Priority (Port C22S for 2070): 2

Port Configuration (MM) 1-5-2 to 1-5-4

Port	2 (C50S)	3A (C21S)	3B (C22S)
Comm Module	None	Auto	Auto
Protocol	NTCIP	NTCIP	NTCIP
Enable	No	No	No
Data Rate (BPS)	9600	9600	9600
Data, Parity, Stop	8 N 1	8 N 1	8 N 1
Address	0	0	0
Telemetry Response Delay	0.0	0.0	0.0
Duplex - Half or Full	Half	Full	Full
Flow Control	No	Yes	Yes
Group Address	0	0	0
Single Flag Enable	Yes	Yes	Yes
RTS to CTS Delay	n/a	n/a	0.0
RTS Turn Off Delay	n/a	n/a	0.0
Dropout Time	10	10	10
Early RTS	n/a	n/a	No
Telemetry Mode	n/a	n/a	FSK
ATCS Railroad	0	n/a	n/a
ATCS Railroad Line	0	n/a	n/a
ATCS Group	0	n/a	n/a
Wayside Device	0	n/a	n/a
ATC Device	0	n/a	n/a
Wayside Subnode	0	n/a	n/a
ATC Subnode	0	n/a	n/a

ECPIP (MM) 1-5-6

Controller Address: 0
 Expanded System Detector Address: 0

System Detector Assignment

System Detector	Local Detector

Wireless Configuration (MM) 1-5-7

Wireless Channel Number: 1
 Wireless Access Code: 327423274

Castle Rock, CO



Solutions that Move the World™

250 - Allen Way @ Allen St - Cobalt @ 10.50.60.64 - Econolite Type - Cobalt

Configuration Logging / Display

Event Logging (MM) 1-6-1

Critical RFE's (MMU/TF)	Yes	3 Critical Errors Within 24 Hours	Yes
MMU Flash Faults	Yes	Local Flash Fault	Yes
Non-Critical RFE's (Det/Test)	Yes	Detector Errors	Yes
Coordination Errors	Yes	Controller Download	Yes
Preemption Events	Yes	TSP Events	Yes
Power On/Off	Yes	Low Battery	Yes
Access	Yes	Data Change	Yes
Online / Offline	Yes		

Alarm Event	1	2	3	4	5	6	7	8	9	10	11	12	13	14	15	16
Enable Logging	X	X	X	X	X	X	X	X	X	X	X	X	X	X	X	X

Display Options (MM) 1-7-2

Key Click Enable:	Yes
Switch to Graphics Mode:	No
LED Mode:	Auto
Display Mode:	Advanced
Trans Mode Pop-Up Disable:	No

Sign On (MM) 8-5

Sign On Message Line 1: Allen Way & Allen Street
 Sign On Message Line 2:

Software Modules (MM) 8-7

Application Version: 32.64.00
 OS (Boot) Version: 06.04.00

Castle Rock, CO



Solutions that Move the World™

250 - Allen Way @ Allen St - Cobalt @ 10.50.60.64 - Econolite Type - Cobalt

Logic Processor Page 1
Logic Statement Control (MM)
1-8-1

Logic #	Statement Control
---------	-------------------

Castle Rock, CO



Solutions that Move the World™

250 - Allen Way @ Allen St - Cobalt @ 10.50.60.64 - Econolite Type - Cobalt

Logic Processor Page 2

Logic Statements (MM) 1-8-2

Castle Rock, CO



Solutions that Move the World™

250 - Allen Way @ Allen St - Cobalt @ 10.50.60.64 - Econolite Type - Cobalt

Controller Timing Plan (MM) 2-1

Plan 1 - ""

Phase	1	2	3	4	5	6	7	8	9	10	11	12	13	14	15	16
Direction	N-L	S-T	E-L	W-T	S-L	N-T	W-L	E-T	N	N	N	N	N	N	N	N
Min Green	0	15	4	4	7	15	4	5	0	0	0	0	0	0	0	0
Bk Min Green	0	0	0	0	0	0	0	0	0	0	0	0	0	0	0	0
CS Min Green	0	0	0	0	0	0	0	0	0	0	0	0	0	0	0	0
Delay Green	0	0	0	0	0	0	0	0	0	0	0	0	0	0	0	0
Walk	0	5	0	6	0	5	0	7	0	0	0	0	0	0	0	0
Walk2	0	0	0	0	0	0	0	0	0	0	0	0	0	0	0	0
Walk Max	0	0	0	0	0	0	0	0	0	0	0	0	0	0	0	0
Ped Clear	0	17	0	25	0	13	0	27	0	0	0	0	0	0	0	0
Ped Clear 2	0	0	0	0	0	0	0	0	0	0	0	0	0	0	0	0
Ped Clear Max	0	0	0	0	0	0	0	0	0	0	0	0	0	0	0	0
Ped CO	0	0	0	0	0	0	0	0	0	0	0	0	0	0	0	0
Vehicle Ext	3.0	5.0	3.0	3.0	3.0	5.0	0.0	3.0	0.0	0.0	0.0	0.0	0.0	0.0	0.0	0.0
Vehicle Ext 2	0.0	0.0	0.0	0.0	0.0	0.0	0.0	0.0	0.0	0.0	0.0	0.0	0.0	0.0	0.0	0.0
Max1	0	40	20	20	20	40	0	20	0	0	0	0	0	0	0	0
Max2	0	16	12	12	16	12	0	12	0	0	0	0	0	0	0	0
Max3	0	0	0	0	0	0	0	0	0	0	0	0	0	0	0	0
DYM Max	0	0	0	0	0	0	0	0	0	0	0	0	0	0	0	0
Dym Step	0.0	0.0	0.0	0.0	0.0	0.0	0.0	0.0	0.0	0.0	0.0	0.0	0.0	0.0	0.0	0.0
Yellow	3.0	3.0	3.0	4.0	3.0	3.0	0.0	4.0	0.0	0.0	0.0	0.0	0.0	0.0	0.0	0.0
Red Clear	2.0	2.0	2.0	2.0	2.0	2.0	0.0	2.0	0.0	0.0	0.0	0.0	0.0	0.0	0.0	0.0
Red Max	0.0	0.0	0.0	0.0	0.0	0.0	0.0	0.0	0.0	0.0	0.0	0.0	0.0	0.0	0.0	0.0
Red Revert	2.0	2.0	2.0	2.0	2.0	2.0	2.0	2.0	0.0	0.0	0.0	0.0	0.0	0.0	0.0	0.0
Act B4	0	0	0	0	0	0	0	0	0	0	0	0	0	0	0	0
Sec/Act	0.0	0.0	0.0	0.0	0.0	0.0	0.0	0.0	0.0	0.0	0.0	0.0	0.0	0.0	0.0	0.0
Max Int	0	0	0	0	0	0	0	0	0	0	0	0	0	0	0	0
Time B4	0	0	0	0	0	0	0	0	0	0	0	0	0	0	0	0
Cars Wt	0	0	0	0	0	0	0	0	0	0	0	0	0	0	0	0
STPTDuc	0.0	0.0	0.0	0.0	0.0	0.0	0.0	0.0	0.0	0.0	0.0	0.0	0.0	0.0	0.0	0.0
TTReduc	0	0	0	0	0	0	0	0	0	0	0	0	0	0	0	0
Min Gap	0.0	0.0	0.0	0.0	0.0	0.0	0.0	0.0	0.0	0.0	0.0	0.0	0.0	0.0	0.0	0.0

Plan 2 - ""

Phase	1	2	3	4	5	6	7	8	9	10	11	12	13	14	15	16
Direction	N-L	S-T	E-L	W-T	S-L	N-T	W-L	E-T	N	N	N	N	N	N	N	N
Min Green	5	5	5	5	5	5	5	5	5	5	5	5	5	5	5	5
Bk Min Green	0	0	0	0	0	0	0	0	0	0	0	0	0	0	0	0
CS Min Green	0	0	0	0	0	0	0	0	0	0	0	0	0	0	0	0
Delay Green	0	0	0	0	0	0	0	0	0	0	0	0	0	0	0	0
Walk	0	10	0	10	0	10	0	10	0	10	0	10	0	10	0	10
Walk2	0	0	0	0	0	0	0	0	0	0	0	0	0	0	0	0
Walk Max	0	0	0	0	0	0	0	0	0	0	0	0	0	0	0	0
Ped Clear	0	16	0	16	0	16	0	16	0	16	0	16	0	16	0	16
Ped Clear 2	0	0	0	0	0	0	0	0	0	0	0	0	0	0	0	0
Ped Clear Max	0	0	0	0	0	0	0	0	0	0	0	0	0	0	0	0
Ped CO	0	0	0	0	0	0	0	0	0	0	0	0	0	0	0	0
Vehicle Ext	5.0	5.0	5.0	5.0	5.0	5.0	5.0	5.0	5.0	5.0	5.0	5.0	5.0	5.0	5.0	5.0
Vehicle Ext 2	0.0	0.0	0.0	0.0	0.0	0.0	0.0	0.0	0.0	0.0	0.0	0.0	0.0	0.0	0.0	0.0
Max1	35	35	35	35	35	35	35	35	35	35	35	35	35	35	35	35
Max2	40	40	40	40	40	40	40	40	40	40	40	40	40	40	40	40
Max3	0	0	0	0	0	0	0	0	0	0	0	0	0	0	0	0
DYM Max	0	0	0	0	0	0	0	0	0	0	0	0	0	0	0	0
Dym Step	0.0	0.0	0.0	0.0	0.0	0.0	0.0	0.0	0.0	0.0	0.0	0.0	0.0	0.0	0.0	0.0
Yellow	3.0	3.0	3.0	3.0	3.0	3.0	3.0	3.0	3.0	3.0	3.0	3.0	3.0	3.0	3.0	3.0
Red Clear	1.0	1.0	1.0	1.0	1.0	1.0	1.0	1.0	1.0	1.0	1.0	1.0	1.0	1.0	1.0	1.0
Red Max	0.0	0.0	0.0	0.0	0.0	0.0	0.0	0.0	0.0	0.0	0.0	0.0	0.0	0.0	0.0	0.0
Red Revert	2.0	2.0	2.0	2.0	2.0	2.0	2.0	2.0	2.0	2.0	2.0	2.0	2.0	2.0	2.0	2.0
Act B4	0	0	0	0	0	0	0	0	0	0	0	0	0	0	0	0
Sec/Act	0.0	0.0	0.0	0.0	0.0	0.0	0.0	0.0	0.0	0.0	0.0	0.0	0.0	0.0	0.0	0.0
Max Int	0	0	0	0	0	0	0	0	0	0	0	0	0	0	0	0
Time B4	0	0	0	0	0	0	0	0	0	0	0	0	0	0	0	0
Cars Wt	0	0	0	0	0	0	0	0	0	0	0	0	0	0	0	0
STPTDuc	0.0	0.0	0.0	0.0	0.0	0.0	0.0	0.0	0.0	0.0	0.0	0.0	0.0	0.0	0.0	0.0
TTReduc	0	0	0	0	0	0	0	0	0	0	0	0	0	0	0	0
Min Gap	0.0	0.0	0.0	0.0	0.0	0.0	0.0	0.0	0.0	0.0	0.0	0.0	0.0	0.0	0.0	0.0

Plan 3 - ""

Phase	1	2	3	4	5	6	7	8	9	10	11	12	13	14	15	16
Direction	N-L	S-T	E-L	W-T	S-L	N-T	W-L	E-T	N	N	N	N	N	N	N	N
Min Green	5	5	5	5	5	5	5	5	5	5	5	5	5	5	5	5
Bk Min Green	0	0	0	0	0	0	0	0	0	0	0	0	0	0	0	0
CS Min Green	0	0	0	0	0	0	0	0	0	0	0	0	0	0	0	0
Delay Green	0	0	0	0	0	0	0	0	0	0	0	0	0	0	0	0
Walk	0	10	0	10	0	10	0	10	0	10	0	10	0	10	0	10
Walk2	0	0	0	0	0	0	0	0	0	0	0	0	0	0	0	0
Walk Max	0	0	0	0	0	0	0	0	0	0	0	0	0	0	0	0
Ped Clear	0	16	0	16	0	16	0	16	0	16	0	16	0	16	0	16
Ped Clear 2	0	0	0	0	0	0	0	0	0	0	0	0	0	0	0	0
Ped Clear Max	0	0	0	0	0	0	0	0	0	0	0	0	0	0	0	0
Ped CO	0	0	0	0	0	0	0	0	0	0	0	0	0	0	0	0
Vehicle Ext	5.0	5.0	5.0	5.0	5.0	5.0	5.0	5.0	5.0	5.0	5.0	5.0	5.0	5.0	5.0	5.0
Vehicle Ext 2	0.0	0.0	0.0	0.0	0.0	0.0	0.0	0.0	0.0	0.0	0.0	0.0	0.0	0.0	0.0	0.0
Max1	35	35	35	35	35	35	35	35	35	35	35	35	35	35	35	35
Max2	40	40	40	40	40	40	40	40	40	40	40	40	40	40	40	40
Max3	0	0	0	0	0	0	0	0	0	0	0	0	0	0	0	0
DYM Max	0	0	0	0	0	0	0	0	0	0	0	0	0	0	0	0
Dym Step	0.0	0.0	0.0	0.0	0.0	0.0	0.0	0.0	0.0	0.0	0.0	0.0	0.0	0.0	0.0	0.0
Yellow	3.0	3.0	3.0	3.0	3.0	3.0	3.0	3.0	3.0	3.0	3.0	3.0	3.0	3.0	3.0	3.0
Red Clear	1.0	1.0	1.0	1.0	1.0	1.0	1.0	1.0	1.0	1.0	1.0	1.0	1.0	1.0	1.0	1.0
Red Max	0.0	0.0	0.0	0.0	0.0	0.0	0.0	0.0	0.0	0.0	0.0	0.0	0.0	0.0	0.0	0.0
Red Revert	2.0	2.0	2.0	2.0	2.0	2.0	2.0	2.0	2.0	2.0	2.0	2.0	2.0	2.0	2.0	2.0
Act B4	0	0	0	0	0	0	0	0	0	0	0	0	0	0	0	0
Sec/Act	0.0	0.0	0.0	0.0	0.0	0.0	0.0	0.0	0.0	0.0	0.0	0.0	0.0	0.0	0.0	0.0
Max Int	0	0	0	0	0	0	0	0	0	0	0	0	0	0	0	0
Time B4	0	0	0	0	0	0	0	0	0	0	0	0	0	0	0	0
Cars Wt	0	0	0	0	0	0	0	0	0	0	0	0	0	0	0	0
STPTDuc	0.0	0.0	0.0	0.0	0.0	0.0	0.0	0.0	0.0	0.0	0.0	0.0	0.0	0.0	0.0	0.0
TTReduc	0	0	0	0	0	0	0	0	0	0	0	0	0	0	0	0
Min Gap	0.0	0.0	0.0	0.0	0.0	0.0	0.0	0.0	0.0	0.0	0.0	0.0	0.0	0.0	0.0	0.0

Plan 4 - ""

Phase	1	2	3	4	5	6	7	8	9	10	11	12	13	14	15	16
Direction	N-L	S-T	E-L	W-T	S-L	N-T	W-L	E-T	N	N	N	N	N	N	N	N
Min Green	5	5	5	5	5	5	5	5	5	5	5	5	5	5	5	5
Bk Min Green	0	0	0	0	0	0	0	0	0	0	0	0	0	0	0	0
CS Min Green	0	0	0	0	0	0	0	0	0	0	0	0	0	0	0	0
Delay Green	0	0	0	0	0	0	0	0	0	0	0	0	0	0	0	0
Walk	0	10	0	10	0	10	0	10	0	10	0	10	0	10	0	10
Walk2	0	0	0	0	0	0	0	0	0	0	0	0	0	0	0	0
Walk Max	0	0	0	0	0	0	0	0	0	0	0	0	0	0	0	0
Ped Clear	0	16	0	16	0	16	0	16	0	16	0	16	0	16	0	16
Ped Clear 2	0	0	0	0	0	0	0	0	0	0	0	0	0	0	0	0
Ped Clear Max	0	0	0	0	0	0	0	0	0	0	0	0	0	0	0	0
Ped CO	0	0	0	0	0	0	0	0	0	0	0	0	0	0	0	0
Vehicle Ext	5.0	5.0	5.0	5.0	5.0	5.0	5.0	5.0	5.0	5.0	5.0	5.0	5.0	5.0	5.0	5.0
Vehicle Ext 2	0.0	0.0	0.0	0.0	0.0	0.0	0.0	0.0	0.0	0.0	0.0	0.0	0.0	0.0	0.0	0.0
Max1	35	35	35	35	35	35	35	35	35	35	35	35	35	35	35	35
Max2	40	40	40	40	40	40	40	40	40	40	40	40	40	40	40	40
Max3	0	0	0	0	0	0	0	0	0	0	0	0	0	0	0	0
DYM Max	0	0	0	0	0	0	0	0	0	0	0	0	0	0	0	0
Dym Step	0.0	0.0	0.0	0.0	0.0	0.0	0.0	0.0	0.0	0.0	0.0	0.0	0.0	0.0	0.0	0.0
Yellow	3.0	3.0	3.0	3.0	3.0	3.0	3.0	3.0	3.0	3.0	3.0	3.0	3.0	3.0	3.0	3.0
Red Clear	1.0	1.0	1.0	1.0	1.0	1.0	1.0	1.0	1.0	1.0	1.0	1.0	1.0	1.0	1.0	1.0
Red Max	0.0	0.0	0.0	0.0	0.0	0.0	0.0	0.0	0.0	0.0	0.0	0.0	0.0	0.0	0.0	0.0
Red Revert	2.0	2.0	2.0	2.0	2.0	2.0	2.0	2.0	2.0	2.0	2.0	2.0	2.0	2.0	2.0	2.0
Act B4	0	0	0	0	0	0	0	0	0	0	0	0	0	0	0	0
Sec/Act	0.0	0.0	0.0	0.0	0.0	0.0	0.0	0.0	0.0	0.0	0.0	0.0	0.0	0.0	0.0	0.0
Max Int	0	0	0	0	0	0	0	0	0	0	0	0	0	0	0	0
Time B4	0	0	0	0	0	0	0	0	0	0	0	0	0	0	0	0
Cars Wt	0	0	0	0	0	0	0	0	0	0	0	0	0	0	0	0
STPTDuc	0.0	0.0	0.0	0.0	0.0	0.0	0.0	0.0	0.0	0.0	0.0	0.0	0.0	0.0	0.0	0.0
TTReduc	0	0	0	0	0	0	0	0	0	0	0	0	0	0	0	0
Min Gap	0.0	0.0	0.0	0.0	0.0	0.0	0.0	0.0	0.0	0.0	0.0	0.0	0.0	0.0	0.0	0.0

Castle Rock, CO



Solutions that Move the World™

250 - Allen Way @ Allen St - Cobalt @ 10.50.60.64 - Econolite Type - Cobalt

Controller Overlaps
Vehicle Overlaps (MM) 2-2

Overlap	Type	Lag Green	Yellow	Red	Adv. Green
---------	------	-----------	--------	-----	------------

Phases

Overlap	Phase	Included	Protect	Ped Protect	Not Overlap	Modifier	Lag X Phases	Lag 2 Phases	Flash Green
D	4	Yes	No	No	No		No	No	1-F1
D	8	Yes	No	No	No		No	No	1-F1

PPLT FYA

Overlap	Protected Phase (Left Turn)	Permissive Phase (Opposing Thru)	Flashing Arrow Output	Flashing Arrow Output CH	Delay Start of FYA	Delay Start of Clearance	Action Plan SF Bit Disable	Ped Protected Enable
B	3	4	Green Overlap	14	0.0	0.0	2	n/a
C	5	6	Green Overlap	15	0.0	0.0	3	n/a

Guaranteed Minimum Time Data (MM) 2-4

Phase	Min Green	Walk	Ped Clear	Yellow	Red Clear	Overlap Green
A01	3	0	7	3.0	0.0	5
B02	3	0	7	3.0	0.0	5
C03	3	0	7	3.0	0.0	5
D04	3	0	7	3.0	0.0	5
E05	3	0	7	3.0	0.0	5
F06	3	0	7	3.0	0.0	5
G07	3	0	7	3.0	0.0	5
H08	3	0	7	3.0	0.0	5
I09	5	0	7	3.0	0.0	5
J10	5	0	7	3.0	0.0	5
K11	5	0	7	3.0	0.0	5
L12	5	0	7	3.0	0.0	5
M13	5	0	7	3.0	0.0	5
N14	5	0	7	3.0	0.0	5
O15	5	0	7	3.0	0.0	5
P16	5	0	7	3.0	0.0	5

Castle Rock, CO



Solutions that Move the World™

250 - Allen Way @ Allen St - Cobalt @ 10.50.60.64 - Econolite Type - Cobalt

Controller Pedestrian Overlaps
Vehicle / Pedestrian Overlaps (MM) 2-3

Included	Pedestrian Overlaps
----------	---------------------

Castle Rock, CO



Solutions that Move the World™

250 - Allen Way @ Allen St - Cobalt @ 10.50.60.64 - Econolite Type - Cobalt

Controller Start / Flash Data (MM) 2-5

Start Up

Phase	Phase Setting
1	.
2	Y
3	.
4	.
5	.
6	Y
7	.
8	.
9	.
10	.
11	.
12	.
13	.
14	.
15	.
16	.

Overlap
A
B
C
D

Flash Thru Mon: No
 Flash Time: 0
 All Red: 6
 Power Start Seq: 1
 MUTCD Enabled: No
 Y->G: n/a

Automatic Flash

Entry
2
6

Exit
2
6

Overlap Exit
A
B
C
D

Flash Thru Mon: No
 Exit Flash: W
 Minimum Flash: 8
 Mimimum Recall: No
 Cycle Through Phase: No

Castle Rock, CO



Solutions that Move the World™

250 - Allen Way @ Allen St - Cobalt @ 10.50.60.64 - Econolite Type - Cobalt

Controller Options

Controller Options (MM) 2-6-1

Phase	1	2	3	4	5	6	7	8	9	10	11	12	13	14	15	16
Flashing Grn Ph
Guar Passage																
Non-Act I		X					X									
Non-Act II			X					X								
Dual Entry	X	X	X	X	X											
Cond Service																
Cond Reservice																
Ped Re-Service																
Rest In Walk																
Flashing Walk																
Ped Clr-Yel																
Ped Clr-Red																
IGRN + Veh Ext																

Ped Clear Protect: Off Unit Red Revert: 2.0 MUTCD 3 Seconds Don't Walk: No

Pre-Timed Mode (MM) 2-7

Enable Pre-Timed Mode: No Free Input Disables Pre-Timed: No

Phase	1	2	3	4	5	6	7	8	9	10	11	12	13	14	15	16
Pre-Timed																

Phase Recall Options (MM) 2-8

Plan # 1

	1	2	3	4	5	6	7	8	9	10	11	12	13	14	15	16
Lock Detector																
Vehicle Recall		X				X										
Ped Recall																
Max Recall																
Soft Recall																
No Rest																
AI Calc																

Castle Rock, CO



Solutions that Move the World™

250 - Allen Way @ Allen St - Cobalt @ 10.50.60.64 - Econolite Type - Cobalt

Coordination Options

Options (MM) 3-1

Manual Pattern	Auto	ECPI Coord	Yes
System Source	SYS	System Format	PTN
Splits In	Seconds	Offsets In	Seconds
Transition	Dwell	Max Select	MAXINH
Dwell / Add Time	0		
Delay Coord Wk-LZ	No	Force Off	Float
Offset Reference	Yellow	Use Ped Time	No
Ped Recall	No	Ped Reservice	No
Local Zero Override	No	FO Added Ini Green	No
Re-sync Count	0	Multisync	No

Auto Perm Minimum Green (Seconds) (MM) 3-4

Phase	1	2	3	4	5	6	7	8	9	10	11	12	13	14	15	16
Minimum Green	0	0	0	0	0	0	0	0	0	0	0	0	0	0	0	0

Split Demand (MM) 3-5

Phase	1	2	3	4	5	6	7	8	9	10	11	12	13	14	15	16
Demand 1																
Demand 2																

Demand	1	2
Detector	0	0
Call Time (Sec)	0	0
Cycle Count	0	0

Castle Rock, CO



Solutions that Move the World™

250 - Allen Way @ Allen St - Cobalt @ 10.50.60.64 - Econolite Type - Cobalt

Coordination Pattern Data

Coordinator Pattern Data (MM) 3-2

Coordinator Pattern # 1

Split Pattern	1	TS2 (Pat-Off)	0-1	Splits In	Seconds
Cycle	60	Std (COS)	9	Offsets In	Seconds
Offset Value	31s	Dwell/Add Time	0		
Actuated Coord	No	Timing Plan	1		
Actuated Walk Rest	No	Sequence	1		
Phase Reservice	No	Action Plan	1		
Max Select	None	Force Off	None		

Split Preference Phases

Phase	1	2	3	4	5	6	7	8	9	10	11	12	13	14	15	16
Description	N-L	S-T	E-L	W-T	S-L	N-T	W-L	E-T	N	N	N	N	N	N	N	N
Splits (Split Pat 1)	0	33	12	15	12	21	0	27	0	0	0	0	0	0	0	0
Pref 1	0	0	0	0	0	0	0	0	0	0	0	0	0	0	0	0
Pref 2	0	0	0	0	0	0	0	0	0	0	0	0	0	0	0	0

Ring	1	2	3	4
Ring Split Ext	0	0	0	0
Ring Displacement	-	0	0	0
Split Sum	60s	60s	0s	0s

Misc. Data					
Veh Perm 1	0	Veh Perm 2	0	Veh Perm 2 Disp	0
Split Demand Pat 1	0	Split Demand Pat 2	0	Crossing Arterial Pat	0

Split Pattern

Phase	1	2	3	4	5	6	7	8	9	10	11	12	13	14	15	16
Coord Phase		X				X										
Vehicle Recall																
Pedestrian Recall																
Recall to Max. Time																
Omit Phase									X	X	X	X	X	X	X	X
Special Function Outputs																

Coordinator Pattern # 2

Split Pattern	2	TS2 (Pat-Off)	0-2	Splits In	Seconds
Cycle	100	Std (COS)	17	Offsets In	Seconds
Offset Value	78s	Dwell/Add Time	0		
Actuated Coord	No	Timing Plan	1		
Actuated Walk Rest	No	Sequence	1		
Phase Reservice	No	Action Plan	1		
Max Select	None	Force Off	None		

Split Preference Phases

Phase	1	2	3	4	5	6	7	8	9	10	11	12	13	14	15	16
Description	N-L	S-T	E-L	W-T	S-L	N-T	W-L	E-T	N	N	N	N	N	N	N	N
Splits (Split Pat 2)	0	52	13	32	16	39	0	45	0	0	0	0	0	0	0	0
Pref 1	0	0	0	0	0	0	0	0	0	0	0	0	0	0	0	0
Pref 2	0	0	0	0	0	0	0	0	0	0	0	0	0	0	0	0

Ring	1	2	3	4
Ring Split Ext	0	0	0	0
Ring Displacement	-	0	0	0
Split Sum	97s	100s	0s	0s

Misc. Data					
Veh Perm 1	0	Veh Perm 2	0	Veh Perm 2 Disp	0
Split Demand Pat 1	0	Split Demand Pat 2	0	Crossing Arterial Pat	0

Split Pattern

Phase	1	2	3	4	5	6	7	8	9	10	11	12	13	14	15	16
Coord Phase																
Vehicle Recall																
Pedestrian Recall																
Recall to Max. Time																
Omit Phase									X	X	X	X	X	X	X	X
Special Function Outputs																

Coordinator Pattern # 3

Split Pattern	3	TS2 (Pat-Off)	0-3	Splits In	Seconds
Cycle	110	Std (COS)	25	Offsets In	Seconds
Offset Value	88s	Dwell/Add Time	0		
Actuated Coord	No	Timing Plan	1		
Actuated Walk Rest	No	Sequence	1		
Phase Reservice	No	Action Plan	1		
Max Select	None	Force Off	None		

Split Preference Phases

Phase	1	2	3	4	5	6	7	8	9	10	11	12	13	14	15	16
Description	N-L	S-T	E-L	W-T	S-L	N-T	W-L	E-T	N	N	N	N	N	N	N	N
Splits (Split Pat 3)	0	55	17	38	25	30	0	55	0	0	0	0	0	0	0	0
Pref 1	0	0	0	0	0	0	0	0	0	0	0	0	0	0	0	0
Pref 2	0	0	0	0	0	0	0	0	0	0	0	0	0	0	0	0

Ring	1	2	3	4
Ring Split Ext	0	0	0	0
Ring Displacement	-	0	0	0
Split Sum	110s	110s	0s	0s

Misc. Data					
Veh Perm 1	0	Veh Perm 2	0	Veh Perm 2 Disp	0
Split Demand Pat 1	0	Split Demand Pat 2	0	Crossing Arterial Pat	0

Split Pattern

Phase	1	2	3	4	5	6	7	8	9	10	11	12	13	14	15	16
Coord Phase		X				X										
Vehicle Recall																
Pedestrian Recall																
Recall to Max. Time																
Omit Phase									X	X	X	X	X	X	X	X
Special Function Outputs																

Coordinator Pattern # 4

Split Pattern	4	TS2 (Pat-Off)	1-1	Splits In	Seconds
Cycle	100	Std (COS)	33	Offsets In	Seconds
Offset Value	72s	Dwell/Add Time	0		
Actuated Coord	No	Timing Plan	1		
Actuated Walk Rest	No	Sequence	1		
Phase Reservice	No	Action Plan	1		
Max Select	None	Force Off	None		

Split Preference Phases

Phase	1	2	3	4	5	6	7	8	9	10	11	12	13	14	15	16
Description	N-L	S-T	E-L	W-T	S-L	N-T	W-L	E-T	N	N	N	N	N	N	N	N
Splits (Split Pat 4)	0	61	14	25	15	46	0	39	0	0	0	0	0	0	0	0
Pref 1	0	0	0	0	0	0	0	0	0	0	0	0	0	0	0	0
Pref 2	0	0	0	0	0	0	0	0	0	0	0	0	0	0	0	0

Ring	1	2	3	4
Ring Split Ext	0	0	0	0
Ring Displacement	-	0	0	0
Split Sum	100s	100s	0s	0s

Misc. Data					
Veh Perm 1	0	Veh Perm 2	0	Veh Perm 2 Disp	0
Split Demand Pat 1	0	Split Demand Pat 2	0	Crossing Arterial Pat	0

Split Pattern

Phase	1	2	3	4	5	6	7	8	9	10	11	12	13	14	15	16
Coord Phase		X				X										
Vehicle Recall																
Pedestrian Recall																
Recall to Max. Time																
Omit Phase									X	X	X	X	X	X	X	X
Special Function Outputs																

Castle Rock, CO



Solutions that Move the World™

250 - Allen Way @ Allen St - Cobalt @ 10.50.60.64 - Econolite Type - Cobalt

Coordination Split Pattern
Split Pattern Data (MM) 3-3

Split Pattern # 1

Phase	1	2	3	4	5	6	7	8	9	10	11	12	13	14	15	16
Description	N-L	S-T	E-L	W-T	S-L	N-T	W-L	E-T	N	N	N	N	N	N	N	N
Split (seconds)	0	33	12	15	12	21	0	27	0	0	0	0	0	0	0	0
Coord Phase		X				X										
Vehicle Recall																
Pedestrian Recall																
Recall to Max. Time																
Omit Phase									X	X	X	X	X	X	X	X

Ring	1	2	3	4
Split Sum	60s	60s	0s	0s

Split Pattern # 2

Phase	1	2	3	4	5	6	7	8	9	10	11	12	13	14	15	16
Description	N-L	S-T	E-L	W-T	S-L	N-T	W-L	E-T	N	N	N	N	N	N	N	N
Split (seconds)	0	52	13	32	16	39	0	45	0	0	0	0	0	0	0	0
Coord Phase																
Vehicle Recall																
Pedestrian Recall																
Recall to Max. Time																
Omit Phase									X	X	X	X	X	X	X	X

Ring	1	2	3	4
Split Sum	97s	100s	0s	0s

Split Pattern # 3

Phase	1	2	3	4	5	6	7	8	9	10	11	12	13	14	15	16
Description	N-L	S-T	E-L	W-T	S-L	N-T	W-L	E-T	N	N	N	N	N	N	N	N
Split (seconds)	0	55	17	38	25	30	0	55	0	0	0	0	0	0	0	0
Coord Phase		X				X										
Vehicle Recall																
Pedestrian Recall																
Recall to Max. Time																
Omit Phase									X	X	X	X	X	X	X	X

Ring	1	2	3	4
Split Sum	110s	110s	0s	0s

Split Pattern # 4

Phase	1	2	3	4	5	6	7	8	9	10	11	12	13	14	15	16
Description	N-L	S-T	E-L	W-T	S-L	N-T	W-L	E-T	N	N	N	N	N	N	N	N
Split (seconds)	0	61	14	25	15	46	0	39	0	0	0	0	0	0	0	0
Coord Phase		X				X										
Vehicle Recall																
Pedestrian Recall																
Recall to Max. Time																
Omit Phase									X	X	X	X	X	X	X	X

Ring	1	2	3	4
Split Sum	100s	100s	0s	0s

Castle Rock, CO



Solutions that Move the World™

250 - Allen Way @ Allen St - Cobalt @ 10.50.60.64 - Econolite Type - Cobalt

Preempt Plan

Preempt Plan (MM) 4-1

Preempt Plan 3

Phase	1	2	3	4	5	6	7	8	9	10	11	12	13	14	15	16
Overlap	A	B	C	D	E	F	G	H	I	J	K	L	M	N	O	P
Trk Clr Veh
Trk Clr Overlap
Enable Trailing
Dwell Veh	.	X	.	.	.	X
Dwell Ped
Dwell Overlap	.	.	1-F1
Cycling Veh
Cycling Ped
Cycling Overlap
Exit Phases
Exit Calls
Special Function

Enable	Yes	Preempt Override	Yes	Interlock Enable	No
Det Lock	Yes	Delay	0	Inhibit	0
Override Flash	Yes	Duration	10	CLR > GRN	No
Term Ovlp Asap	No	PC Through Yel	No	Terminate Phase	No
Ped Dark	No	Track Clear Rsrv	No	Dwell Flash	Off
Linked Pmt	0	FL Exit Color	Red	Exit Options	Off
Exit Timing Plan	0	Reservice	0	Fault Type	Hard

Ring	1	2	3	4
Free During Pmt	No	No	No	No

Timing	Walk	Ped Clr	Min Grn	Yellow	Red
Entrance	0	255	5	4.0	1.0
	Min Grn	Ext Grn	Max Grn	Yellow	Red
Track Clear	0	0	0	4.0	1.0
	Min Dwell	Pmt Ext	Max Time	Yellow	Red
Dwell / Cycle-Exit	0	0.0	120	4.0	1.0

Preemption Active Out	On	Preempt Act Dwell	No
Other - Priority Preempt	Off	Non-Priority Pmt	Off
Inhibit Extension Time	0.0	Ped Priority Return	Off
Veh Priority Return	Off	Queue Delay	Off
Conditional Delay	Off		

Phase	1	2	3	4	5	6	7	8	9	10	11	12	13	14	15	16
Veh Pri Return %	0	0	0	0	0	0	0	0	0	0	0	0	0	0	0	0

Preempt Plan 5

Phase	1	2	3	4	5	6	7	8	9	10	11	12	13	14	15	16
Overlap	A	B	C	D	E	F	G	H	I	J	K	L	M	N	O	P
Trk Clr Veh
Trk Clr Overlap
Enable Trailing
Dwell Veh	.	.	.	X	.	.	.	X
Dwell Ped
Dwell Overlap	.	1-F1	.	1-F1
Cycling Veh
Cycling Ped
Cycling Overlap
Exit Phases
Exit Calls
Special Function

Enable	Yes	Preempt Override	Yes	Interlock Enable	No
Det Lock	Yes	Delay	0	Inhibit	0
Override Flash	Yes	Duration	10	CLR > GRN	No
Term Ovlp Asap	No	PC Through Yel	No	Terminate Phase	No
Ped Dark	No	Track Clear Rsrv	No	Dwell Flash	Off
Linked Pmt	0	FL Exit Color	Red	Exit Options	Off
Exit Timing Plan	0	Reservice	0	Fault Type	Hard

Ring	1	2	3	4

Free During Pmt No No No No

Timing	Walk	Ped Clr	Min Grn	Yellow	Red
Entrance	0	255	5	4.0	1.0
	Min Grn	Ext Grn	Max Grn	Yellow	Red
Track Clear	0	0	0	4.0	1.0
	Min Dwell	Pmt Ext	Max Time	Yellow	Red
Dwell / Cycle-Exit	0	0.0	120	4.0	1.0

Preemption Active Out	On	Preempt Act Dwell	No
Other - Priority Preempt	Off	Non-Priority Pmt	Off
Inhibit Extension Time	0.0	Ped Priority Return	Off
Veh Priority Return	Off	Queue Delay	Off
Conditional Delay	Off		

Phase	1	2	3	4	5	6	7	8	9	10	11	12	13	14	15	16
Veh Pri Return %	0	0	0	0	0	0	0	0	0	0	0	0	0	0	0	0

Castle Rock, CO



Solutions that Move the World™

250 - Allen Way @ Allen St - Cobalt @ 10.50.60.64 - Econolite Type - Cobalt

Preempt Preempt Filtering**Enable Preempt Filtering & TSP/SCP (MM) 4-2**

Input	Solid	Pulsing
1	...BYPASSED...	...BYPASSED...
2	...BYPASSED...	...BYPASSED...
3	PREEMPTION 3	PREEMPTION 7
4	PREEMPTION 4	PREEMPTION 8
5	PREEMPTION 5	PREEMPTION 9
6	PREEMPTION 6	PREEMPTION 10
7	...BYPASSED...	...BYPASSED...
8	...BYPASSED...	...BYPASSED...
9	...BYPASSED...	...BYPASSED...
10	...BYPASSED...	...BYPASSED...

Castle Rock, CO



Solutions that Move the World™

250 - Allen Way @ Allen St - Cobalt @ 10.50.60.64 - Econolite Type - Cobalt

Preempt TSP/SCP Plan and Split

TSP / SCP Plan (MM) 4-3

TSP/SCP Plan	Enable Option	Signal Type	Det Lock	Delay Time	Max Presence	PMT Enables Reservice	No Delay in TSP	Action SF Inhibit	Reservice Cycles	Bus Heading
1	No	Solid	No	0	0	No	False	0	0	NB
2	No	Solid	No	0	0	No	False	0	0	SB
3	No	Solid	No	0	0	No	False	0	0	EB
4	No	Solid	No	0	0	No	False	0	0	WB
5	No	Solid	No	0	0	No	False	0	0	.
6	No	Solid	No	0	0	No	False	0	0	.

Mode: TSP
 Free Default Pattern: 120
 Headway Allowance: 0

TSP/SCP Plan	1	2	3	4	5	6	7	8	9	10	11	12	13	14	15	16
1
2
3
4
5
6

TSP / SCP Split Pattern (MM) 4-4

TSP/SCP Split Pattern	Max Type	Phase															
		1	2	3	4	5	6	7	8	9	10	11	12	13	14	15	16
4	Max Reduction	255	255	255	255	255	255	255	255	255	255	255	255	255	255	255	255

Castle Rock, CO



Solutions that Move the World™

250 - Allen Way @ Allen St - Cobalt @ 10.50.60.64 - Econolite Type - Cobalt

Time Base Clock/Calendar

Clock/Calendar Data (MM) 5-1

Manual Action Plan: 0
SYNC Reference Time: 00:00
SYNC Reference: Reference Time
Day Light Savings: No
Time Reset Input Set Time: 3:30:00
Standard Time From GMT: 0

Castle Rock, CO



Solutions that Move the World™

250 - Allen Way @ Allen St - Cobalt @ 10.50.60.64 - Econolite Type - Cobalt

**Time Base Action Plan
Action Plan (MM) 5-2**

Action Plan - 1 - "1"

Pattern	1	Override Sys	No
Timing Plan	1	Sequence	1
Veh Detector Plan	1	Det Log	None
Flash	No	Red Rest	No
Veh Det Diag Plan	0	Ped Det Diag Plan	0
Dimming Enable	No	Pmt Veh Priority Ret	No
Pmt Ped Priority Ret	No	Pmt Queue Delay	No
Pmt Cond Delay	No		

Phase	1	2	3	4	5	6	7	8	9	10	11	12	13	14	15	16
Ped Recall																
Walk 2																
Veh Ext 2																
Veh Recall																
Max Recall																
Max 2																
Max 3																
CS Inhibit																
Omit																
Spec Func (1-8)																
Aux Func (1-3)																
	1	2	3	4	5	6	7	8	9	10	11	12	13	14	15	
LP 1-15	-	-	-	-	-	-	-	-	-	-	-	-	-	-	-	-
LP 16-30	-	-	-	-	-	-	-	-	-	-	-	-	-	-	-	-
LP 31-45	-	-	-	-	-	-	-	-	-	-	-	-	-	-	-	-
LP 46-60	-	-	-	-	-	-	-	-	-	-	-	-	-	-	-	-
LP 61-75	-	-	-	-	-	-	-	-	-	-	-	-	-	-	-	-
LP 76-90	-	-	-	-	-	-	-	-	-	-	-	-	-	-	-	-
LP 91-100	-	-	-	-	-	-	-	-	-	-	-	-	-	-	-	-

Action Plan - 2 - "2"

Pattern	2	Override Sys	No
Timing Plan	1	Sequence	1
Veh Detector Plan	1	Det Log	None
Flash	No	Red Rest	No
Veh Det Diag Plan	0	Ped Det Diag Plan	0
Dimming Enable	No	Pmt Veh Priority Ret	No
Pmt Ped Priority Ret	No	Pmt Queue Delay	No
Pmt Cond Delay	No		

Phase	1	2	3	4	5	6	7	8	9	10	11	12	13	14	15	16
Ped Recall																
Walk 2																
Veh Ext 2																
Veh Recall																
Max Recall																
Max 2																
Max 3																
CS Inhibit																
Omit																

Spec Func (1-8)									
-----------------	--	--	--	--	--	--	--	--	--

Aux Func (1-3)			
----------------	--	--	--

	1	2	3	4	5	6	7	8	9	10	11	12	13	14	15
LP 1-15	-	-	-	-	-	-	-	-	-	-	-	-	-	-	-
LP 16-30	-	-	-	-	-	-	-	-	-	-	-	-	-	-	-
LP 31-45	-	-	-	-	-	-	-	-	-	-	-	-	-	-	-
LP 46-60	-	-	-	-	-	-	-	-	-	-	-	-	-	-	-
LP 61-75	-	-	-	-	-	-	-	-	-	-	-	-	-	-	-
LP 76-90	-	-	-	-	-	-	-	-	-	-	-	-	-	-	-
LP 91-100	-	-	-	-	-	-	-	-	-	-	-	-	-	-	-

Action Plan - 3 - "3"

Pattern	3	Override Sys	No
Timing Plan	1	Sequence	1
Veh Detector Plan	1	Det Log	None
Flash	No	Red Rest	No
Veh Det Diag Plan	0	Ped Det Diag Plan	0
Dimming Enable	No	Pmt Veh Priority Ret	No
Pmt Ped Priority Ret	No	Pmt Queue Delay	No
Pmt Cond Delay	No		

Phase	1	2	3	4	5	6	7	8	9	10	11	12	13	14	15	16
Ped Recall																
Walk 2																
Veh Ext 2																
Veh Recall																
Max Recall																
Max 2																
Max 3																
CS Inhibit																
Omit																

Spec Func (1-8)								
-----------------	--	--	--	--	--	--	--	--

Aux Func (1-3)			
----------------	--	--	--

	1	2	3	4	5	6	7	8	9	10	11	12	13	14	15
LP 1-15	-	-	-	-	-	-	-	-	-	-	-	-	-	-	-
LP 16-30	-	-	-	-	-	-	-	-	-	-	-	-	-	-	-
LP 31-45	-	-	-	-	-	-	-	-	-	-	-	-	-	-	-
LP 46-60	-	-	-	-	-	-	-	-	-	-	-	-	-	-	-
LP 61-75	-	-	-	-	-	-	-	-	-	-	-	-	-	-	-
LP 76-90	-	-	-	-	-	-	-	-	-	-	-	-	-	-	-
LP 91-100	-	-	-	-	-	-	-	-	-	-	-	-	-	-	-

Action Plan - 19 - "19"

Pattern	Free	Override Sys	No
Timing Plan	1	Sequence	1
Veh Detector Plan	1	Det Log	None
Flash	No	Red Rest	No
Veh Det Diag Plan	0	Ped Det Diag Plan	0
Dimming Enable	No	Pmt Veh Priority Ret	No
Pmt Ped Priority Ret	No	Pmt Queue Delay	No
Pmt Cond Delay	No		

Phase	1	2	3	4	5	6	7	8	9	10	11	12	13	14	15	16
Ped Recall																
Walk 2																
Veh Ext 2																
Veh Recall		X				X										
Max Recall																
Max 2																
Max 3																
CS Inhibit																
Omit																

Spec Func (1-8)									
-----------------	--	--	--	--	--	--	--	--	--

Aux Func (1-3)			
----------------	--	--	--

	1	2	3	4	5	6	7	8	9	10	11	12	13	14	15
LP 1-15	-	-	-	-	-	-	-	-	-	-	-	-	-	-	-
LP 16-30	-	-	-	-	-	-	-	-	-	-	-	-	-	-	-
LP 31-45	-	-	-	-	-	-	-	-	-	-	-	-	-	-	-
LP 46-60	-	-	-	-	-	-	-	-	-	-	-	-	-	-	-
LP 61-75	-	-	-	-	-	-	-	-	-	-	-	-	-	-	-
LP 76-90	-	-	-	-	-	-	-	-	-	-	-	-	-	-	-
LP 91-100	-	-	-	-	-	-	-	-	-	-	-	-	-	-	-

Action Plan - 20 - "20"

Pattern	Free	Override Sys	No
Timing Plan	1	Sequence	1
Veh Detector Plan	1	Det Log	None
Flash	No	Red Rest	No
Veh Det Diag Plan	0	Ped Det Diag Plan	0
Dimming Enable	No	Pmt Veh Priority Ret	No
Pmt Ped Priority Ret	No	Pmt Queue Delay	No
Pmt Cond Delay	No		

Phase	1	2	3	4	5	6	7	8	9	10	11	12	13	14	15	16
Ped Recall																
Walk 2																
Veh Ext 2																
Veh Recall		X				X										
Max Recall																
Max 2																
Max 3																
CS Inhibit																
Omit																

Spec Func (1-8)								
-----------------	--	--	--	--	--	--	--	--

Aux Func (1-3)			
----------------	--	--	--

	1	2	3	4	5	6	7	8	9	10	11	12	13	14	15
LP 1-15	-	-	-	-	-	-	-	-	-	-	-	-	-	-	-
LP 16-30	-	-	-	-	-	-	-	-	-	-	-	-	-	-	-
LP 31-45	-	-	-	-	-	-	-	-	-	-	-	-	-	-	-
LP 46-60	-	-	-	-	-	-	-	-	-	-	-	-	-	-	-
LP 61-75	-	-	-	-	-	-	-	-	-	-	-	-	-	-	-
LP 76-90	-	-	-	-	-	-	-	-	-	-	-	-	-	-	-
LP 91-100	-	-	-	-	-	-	-	-	-	-	-	-	-	-	-

Action Plan - 21 - "21"

Pattern	Free	Override Sys	No
Timing Plan	1	Sequence	1
Veh Detector Plan	1	Det Log	None
Flash	No	Red Rest	No
Veh Det Diag Plan	0	Ped Det Diag Plan	0
Dimming Enable	No	Pmt Veh Priority Ret	No
Pmt Ped Priority Ret	No	Pmt Queue Delay	No
Pmt Cond Delay	No		

Phase	1	2	3	4	5	6	7	8	9	10	11	12	13	14	15	16
Ped Recall																
Walk 2																
Veh Ext 2																
Veh Recall		X				X										
Max Recall																
Max 2	X	X	X	X	X	X	X	X								
Max 3																
CS Inhibit																
Omit																

Spec Func (1-8)

Aux Func (1-3)

	1	2	3	4	5	6	7	8	9	10	11	12	13	14	15
LP 1-15	-	-	-	-	-	-	-	-	-	-	-	-	-	-	-
LP 16-30	-	-	-	-	-	-	-	-	-	-	-	-	-	-	-
LP 31-45	-	-	-	-	-	-	-	-	-	-	-	-	-	-	-
LP 46-60	-	-	-	-	-	-	-	-	-	-	-	-	-	-	-
LP 61-75	-	-	-	-	-	-	-	-	-	-	-	-	-	-	-
LP 76-90	-	-	-	-	-	-	-	-	-	-	-	-	-	-	-
LP 91-100	-	-	-	-	-	-	-	-	-	-	-	-	-	-	-

Castle Rock, CO



Solutions that Move the World™

250 - Allen Way @ Allen St - Cobalt @ 10.50.60.64 - Econolite Type - Cobalt

Time Base Day Plan/Schedule
Day Plan (MM) 5-3

Day Plan #1 - "1"

Event	Action Plan	Start Time
1	21	23:00
2	20	05:30
3	19	15:00
4	20	18:00

Schedule (MM) 5-4

Schedule Number - 1

Day Plan No.: 1

Month	JAN	FEB	MAR	APR	MAY	JUN	JUL	AUG	SEP	OCT	NOV	DEC
	X	X	X	X	X	X	X	X	X	X	X	X

Day (DOW)	SUN	MON	TUE	WED	THU	FRI	SAT
	X	X	X	X	X	X	X

Day (DOM)	1	2	3	4	5	6	7	8	9	10	11
	X	X	X	X	X	X	X	X	X	X	X
	12	13	14	15	16	17	18	19	20	21	22
	X	X	X	X	X	X	X	X	X	X	X
	23	24	25	26	27	28	29	30	31		
	X	X	X	X	X	X	X	X	X		

Castle Rock, CO



Solutions that Move the World™

250 - Allen Way @ Allen St - Cobalt @ 10.50.60.64 - Econolite Type - Cobalt

Time Base Exceptions
Exception Day Program (MM) 5-5

Excep Day	Float/Fixed	Mon/Mon	DOW/DOM	WOM/Year	Day Plan
-----------	-------------	---------	---------	----------	----------

Castle Rock, CO



Solutions that Move the World™

250 - Allen Way @ Allen St - Cobalt @ 10.50.60.64 - Econolite Type - Cobalt

Detectors

Detectors - Pg 1

Veh Det Phase Assignment (MM) 6-1

Vehicle Detector Plan Number - 1

Veh Detector	Assigned Phase	Called Phase	Type
1	1		S
2	2		S
3	2		S
4	2		C
5	3	4	S
6	4		S
7	4		S
8	4		C
9	1		S
10	2		S
11	2		G
14	4		S
15	4		G
17	5	6	S
18	6		S
19	6		S
20	6		C
21	7		S
22	8		S
23	8		S
24	8		C
25	5	6	S
26	6		S
27	6		G
29	7		S
30	8		S
31	8		G

Vehicle Detector Plan Number - 2

Veh Detector	Assigned Phase	Called Phase	Type
1	1		S
2	2		S
3	3		S
4	4		C
5	5		S
6	6		S
7	7		S
8	8		C
9	2		S
10	2		S
11	4		G
12	4		S
13	6		S
14	6		S
15	8		G
16	8		S
17	1		S
18	2		S
19	3		S
20	4		C
21	5		S
22	6		S
23	7		S
24	8		C
25	2		S
26	4		S
27	6		G
28	8		S

Vehicle Detector Plan Number - 3

Veh Detector	Assigned Phase	Called Phase	Type
1	1		S
2	2		S
3	3		S

4	4		C
5	5		S
6	6		S
7	7		S
8	8		C
9	2		S
10	2		S
11	4		G
12	4		S
13	6		S
14	6		S
15	8		G
16	8		S
17	1		S
18	2		S
19	3		S
20	4		C
21	5		S
22	6		S
23	7		S
24	8		C
25	2		S
26	4		S
27	6		G
28	8		S

Vehicle Detector Plan Number - 4

Veh Detector	Assigned Phase	Called Phase	Type
1	1		S
2	2		S
3	3		S
4	4		C
5	5		S
6	6		S
7	7		S
8	8		C
9	2		S
10	2		S
11	4		G
12	4		S
13	6		S
14	6		S
15	8		G
16	8		S
17	1		S
18	2		S
19	3		S
20	4		C
21	5		S
22	6		S
23	7		S
24	8		C
25	2		S
26	4		S
27	6		G
28	8		S

Vehicle Detector Setup (MM) 6-2

Veh Detector	Type	TS2 Detector	Description
1	S-STANDARD	Yes	
2	S-STANDARD	Yes	
3	S-STANDARD	Yes	
4	C-CALLING	Yes	
5	S-STANDARD	Yes	
6	S-STANDARD	Yes	
7	S-STANDARD	Yes	
8	C-CALLING	Yes	
9	S-STANDARD	Yes	
10	S-STANDARD	Yes	
11	G-GREEN EXT	Yes	
12	S-STANDARD	Yes	
13	S-STANDARD	Yes	
14	S-STANDARD	Yes	
15	G-GREEN EXT	Yes	
16	S-STANDARD	Yes	
17	S-STANDARD	Yes	
18	S-STANDARD	Yes	
19	S-STANDARD	Yes	
20	C-CALLING	Yes	
21	S-STANDARD	Yes	
22	S-STANDARD	Yes	

23	S-STANDARD	Yes	
24	C-CALLING	Yes	
25	S-STANDARD	Yes	
26	S-STANDARD	Yes	
27	G-GREEN EXT	Yes	
28	S-STANDARD	Yes	
29	S-STANDARD	Yes	
30	S-STANDARD	Yes	
31	G-GREEN EXT	Yes	
32	S-STANDARD	Yes	
33	S-STANDARD	Yes	
34	S-STANDARD	Yes	
35	S-STANDARD	Yes	
36	S-STANDARD	Yes	
37	S-STANDARD	Yes	
38	S-STANDARD	Yes	
39	S-STANDARD	Yes	
40	S-STANDARD	Yes	
41	S-STANDARD	Yes	
42	S-STANDARD	Yes	
43	S-STANDARD	Yes	
44	S-STANDARD	Yes	
45	S-STANDARD	Yes	
46	S-STANDARD	Yes	
47	S-STANDARD	Yes	
48	S-STANDARD	Yes	
49	S-STANDARD	Yes	
50	S-STANDARD	Yes	
51	S-STANDARD	Yes	
52	S-STANDARD	Yes	
53	S-STANDARD	Yes	
54	S-STANDARD	Yes	
55	S-STANDARD	Yes	
56	S-STANDARD	Yes	
57	S-STANDARD	Yes	
58	S-STANDARD	Yes	
59	S-STANDARD	Yes	
60	S-STANDARD	Yes	
61	S-STANDARD	Yes	
62	S-STANDARD	Yes	
63	S-STANDARD	Yes	
64	S-STANDARD	Yes	

Vehicle Detector Plan Number - 1

Veh Detector	Phase	ECPI Log	Call Option	Delay Time	Ext Option	Extend Time / Passage Time	Queue Lim. / Discon. Time	Use Added Initial	Cross Switch Ph	Lock In	NTCIP Vol.	NTCIP Occ.	Pmt Queue Delay
1	1	No	Yes	0.0	Passage	0.0	0	No	0	None	No	No	No
2	2	No	Yes	0.0	Passage	0.0	0	No	0	None	No	No	No
3	2	No	Yes	0.0	Passage	0.0	0	No	0	None	No	No	No
4	2	No	Yes	0.0	None	0.0	0	No	0	None	No	No	No
5	3	No	Yes	0.0	Passage	0.0	0	No	0	None	No	No	No
6	4	No	Yes	0.0	Passage	0.0	0	No	0	None	No	No	No
7	4	No	Yes	0.0	Passage	0.0	0	No	0	None	No	No	No
8	4	No	Yes	0.0	None	0.0	0	No	0	None	No	No	No
9	1	No	Yes	0.0	Passage	0.0	0	No	0	None	No	No	No
10	2	No	Yes	0.0	Passage	0.0	0	No	0	None	No	No	No
11	2	No	Yes	0.0	Passage	0.0	0	No	0	None	No	No	No
12	0	No	Yes	0.0	Passage	0.0	0	No	0	None	No	No	No
13	0	No	Yes	0.0	Passage	0.0	0	No	0	None	No	No	No
14	4	No	Yes	0.0	Passage	0.0	0	No	0	None	No	No	No
15	4	No	Yes	0.0	Passage	0.0	0	No	0	None	No	No	No
16	0	No	Yes	0.0	Passage	0.0	0	No	0	None	No	No	No
17	5	No	Yes	0.0	Passage	0.0	0	No	0	None	No	No	No
18	6	No	Yes	0.0	Passage	0.0	0	No	0	None	No	No	No
19	6	No	Yes	0.0	Passage	0.0	0	No	0	None	No	No	No
20	6	No	Yes	0.0	None	0.0	0	No	0	None	No	No	No
21	7	No	Yes	0.0	Passage	0.0	0	No	0	None	No	No	No
22	8	No	Yes	0.0	Passage	0.0	0	No	0	None	No	No	No
23	8	No	Yes	0.0	Passage	0.0	0	No	0	None	No	No	No
24	8	No	Yes	0.0	None	0.0	0	No	0	None	No	No	No
25	5	No	Yes	0.0	Passage	0.0	0	No	0	None	No	No	No
26	6	No	Yes	0.0	Passage	0.0	0	No	0	None	No	No	No
27	6	No	Yes	0.0	Passage	0.0	0	No	0	None	No	No	No
28	0	No	Yes	0.0	Passage	0.0	0	No	0	None	No	No	No
29	7	No	Yes	0.0	Passage	0.0	0	No	0	None	No	No	No
30	8	No	Yes	0.0	Passage	0.0	0	No	0	None	No	No	No
31	8	No	Yes	0.0	Passage	0.0	0	No	0	None	No	No	No
32	0	No	Yes	0.0	Passage	0.0	0	No	0	None	No	No	No
33	0	No	Yes	0.0	Passage	0.0	0	No	0	None	No	No	No

34	0	No	Yes	0.0	Passage	0.0	0	No	0	None	No	No	No
35	0	No	Yes	0.0	Passage	0.0	0	No	0	None	No	No	No
36	0	No	Yes	0.0	Passage	0.0	0	No	0	None	No	No	No
37	0	No	Yes	0.0	Passage	0.0	0	No	0	None	No	No	No
38	0	No	Yes	0.0	Passage	0.0	0	No	0	None	No	No	No
39	0	No	Yes	0.0	Passage	0.0	0	No	0	None	No	No	No
40	0	No	Yes	0.0	Passage	0.0	0	No	0	None	No	No	No
41	0	No	Yes	0.0	Passage	0.0	0	No	0	None	No	No	No
42	0	No	Yes	0.0	Passage	0.0	0	No	0	None	No	No	No
43	0	No	Yes	0.0	Passage	0.0	0	No	0	None	No	No	No
44	0	No	Yes	0.0	Passage	0.0	0	No	0	None	No	No	No
45	0	No	Yes	0.0	Passage	0.0	0	No	0	None	No	No	No
46	0	No	Yes	0.0	Passage	0.0	0	No	0	None	No	No	No
47	0	No	Yes	0.0	Passage	0.0	0	No	0	None	No	No	No
48	0	No	Yes	0.0	Passage	0.0	0	No	0	None	No	No	No
49	0	No	Yes	0.0	Passage	0.0	0	No	0	None	No	No	No
50	0	No	Yes	0.0	Passage	0.0	0	No	0	None	No	No	No
51	0	No	Yes	0.0	Passage	0.0	0	No	0	None	No	No	No
52	0	No	Yes	0.0	Passage	0.0	0	No	0	None	No	No	No
53	0	No	Yes	0.0	Passage	0.0	0	No	0	None	No	No	No
54	0	No	Yes	0.0	Passage	0.0	0	No	0	None	No	No	No
55	0	No	Yes	0.0	Passage	0.0	0	No	0	None	No	No	No
56	0	No	Yes	0.0	Passage	0.0	0	No	0	None	No	No	No
57	0	No	Yes	0.0	Passage	0.0	0	No	0	None	No	No	No
58	0	No	Yes	0.0	Passage	0.0	0	No	0	None	No	No	No
59	0	No	Yes	0.0	Passage	0.0	0	No	0	None	No	No	No
60	0	No	Yes	0.0	Passage	0.0	0	No	0	None	No	No	No
61	0	No	Yes	0.0	Passage	0.0	0	No	0	None	No	No	No
62	0	No	Yes	0.0	Passage	0.0	0	No	0	None	No	No	No
63	0	No	Yes	0.0	Passage	0.0	0	No	0	None	No	No	No
64	0	No	Yes	0.0	Passage	0.0	0	No	0	None	No	No	No

Vehicle Detector Plan Number - 2

Veh Detector	Phase	ECPI Log	Call Option	Delay Time	Ext Option	Extend Time / Passage Time	Queue Lim. / Discon. Time	Use Added Initial	Cross Switch Ph	Lock In	NTCIP Vol.	NTCIP Occ.	Pmt Queue Delay
1	1	No	Yes	0.0	Passage	0.0	0	No	0	None	No	No	No
2	2	No	Yes	0.0	Passage	0.0	0	No	0	None	No	No	No
3	3	No	Yes	0.0	Passage	0.0	0	No	0	None	No	No	No
4	4	No	Yes	0.0	None	0.0	0	No	0	None	No	No	No
5	5	No	Yes	0.0	Passage	0.0	0	No	0	None	No	No	No
6	6	No	Yes	0.0	Passage	0.0	0	No	0	None	No	No	No
7	7	No	Yes	0.0	Passage	0.0	0	No	0	None	No	No	No
8	8	No	Yes	0.0	None	0.0	0	No	0	None	No	No	No
9	2	No	Yes	0.0	Passage	0.0	0	No	0	None	No	No	No
10	2	No	Yes	0.0	Passage	0.0	0	No	0	None	No	No	No
11	4	No	Yes	0.0	Passage	0.0	0	No	0	None	No	No	No
12	4	No	Yes	0.0	Passage	0.0	0	No	0	None	No	No	No
13	6	No	Yes	0.0	Passage	0.0	0	No	0	None	No	No	No
14	6	No	Yes	0.0	Passage	0.0	0	No	0	None	No	No	No
15	8	No	Yes	0.0	Passage	0.0	0	No	0	None	No	No	No
16	8	No	Yes	0.0	Passage	0.0	0	No	0	None	No	No	No
17	1	No	Yes	0.0	Passage	0.0	0	No	0	None	No	No	No
18	2	No	Yes	0.0	Passage	0.0	0	No	0	None	No	No	No
19	3	No	Yes	0.0	Passage	0.0	0	No	0	None	No	No	No
20	4	No	Yes	0.0	None	0.0	0	No	0	None	No	No	No
21	5	No	Yes	0.0	Passage	0.0	0	No	0	None	No	No	No
22	6	No	Yes	0.0	Passage	0.0	0	No	0	None	No	No	No
23	7	No	Yes	0.0	Passage	0.0	0	No	0	None	No	No	No
24	8	No	Yes	0.0	None	0.0	0	No	0	None	No	No	No
25	2	No	Yes	0.0	Passage	0.0	0	No	0	None	No	No	No
26	4	No	Yes	0.0	Passage	0.0	0	No	0	None	No	No	No
27	6	No	Yes	0.0	Passage	0.0	0	No	0	None	No	No	No
28	8	No	Yes	0.0	Passage	0.0	0	No	0	None	No	No	No
29	0	No	Yes	0.0	Passage	0.0	0	No	0	None	No	No	No
30	0	No	Yes	0.0	Passage	0.0	0	No	0	None	No	No	No
31	0	No	Yes	0.0	Passage	0.0	0	No	0	None	No	No	No
32	0	No	Yes	0.0	Passage	0.0	0	No	0	None	No	No	No
33	0	No	Yes	0.0	Passage	0.0	0	No	0	None	No	No	No
34	0	No	Yes	0.0	Passage	0.0	0	No	0	None	No	No	No
35	0	No	Yes	0.0	Passage	0.0	0	No	0	None	No	No	No
36	0	No	Yes	0.0	Passage	0.0	0	No	0	None	No	No	No
37	0	No	Yes	0.0	Passage	0.0	0	No	0	None	No	No	No
38	0	No	Yes	0.0	Passage	0.0	0	No	0	None	No	No	No
39	0	No	Yes	0.0	Passage	0.0	0	No	0	None	No	No	No
40	0	No	Yes	0.0	Passage	0.0	0	No	0	None	No	No	No
41	0	No	Yes	0.0	Passage	0.0	0	No	0	None	No	No	No
42	0	No	Yes	0.0	Passage	0.0	0	No	0	None	No	No	No
43	0	No	Yes	0.0	Passage	0.0	0	No	0	None	No	No	No
44	0	No	Yes	0.0	Passage	0.0	0	No	0	None	No	No	No
45	0	No	Yes	0.0	Passage	0.0	0	No	0	None	No	No	No

46	0	No	Yes	0.0	Passage	0.0	0	No	0	None	No	No	No
47	0	No	Yes	0.0	Passage	0.0	0	No	0	None	No	No	No
48	0	No	Yes	0.0	Passage	0.0	0	No	0	None	No	No	No
49	0	No	Yes	0.0	Passage	0.0	0	No	0	None	No	No	No
50	0	No	Yes	0.0	Passage	0.0	0	No	0	None	No	No	No
51	0	No	Yes	0.0	Passage	0.0	0	No	0	None	No	No	No
52	0	No	Yes	0.0	Passage	0.0	0	No	0	None	No	No	No
53	0	No	Yes	0.0	Passage	0.0	0	No	0	None	No	No	No
54	0	No	Yes	0.0	Passage	0.0	0	No	0	None	No	No	No
55	0	No	Yes	0.0	Passage	0.0	0	No	0	None	No	No	No
56	0	No	Yes	0.0	Passage	0.0	0	No	0	None	No	No	No
57	0	No	Yes	0.0	Passage	0.0	0	No	0	None	No	No	No
58	0	No	Yes	0.0	Passage	0.0	0	No	0	None	No	No	No
59	0	No	Yes	0.0	Passage	0.0	0	No	0	None	No	No	No
60	0	No	Yes	0.0	Passage	0.0	0	No	0	None	No	No	No
61	0	No	Yes	0.0	Passage	0.0	0	No	0	None	No	No	No
62	0	No	Yes	0.0	Passage	0.0	0	No	0	None	No	No	No
63	0	No	Yes	0.0	Passage	0.0	0	No	0	None	No	No	No
64	0	No	Yes	0.0	Passage	0.0	0	No	0	None	No	No	No

Vehicle Detector Plan Number - 3

Veh Detector	Phase	ECPI Log	Call Option	Delay Time	Ext Option	Extend Time / Passage Time	Queue Lim. / Discon. Time	Use Added Initial	Cross Switch Ph	Lock In	NTCIP Vol.	NTCIP Occ.	Pmt Queue Delay
1	1	No	Yes	0.0	Passage	0.0	0	No	0	None	No	No	No
2	2	No	Yes	0.0	Passage	0.0	0	No	0	None	No	No	No
3	3	No	Yes	0.0	Passage	0.0	0	No	0	None	No	No	No
4	4	No	Yes	0.0	None	0.0	0	No	0	None	No	No	No
5	5	No	Yes	0.0	Passage	0.0	0	No	0	None	No	No	No
6	6	No	Yes	0.0	Passage	0.0	0	No	0	None	No	No	No
7	7	No	Yes	0.0	Passage	0.0	0	No	0	None	No	No	No
8	8	No	Yes	0.0	None	0.0	0	No	0	None	No	No	No
9	2	No	Yes	0.0	Passage	0.0	0	No	0	None	No	No	No
10	2	No	Yes	0.0	Passage	0.0	0	No	0	None	No	No	No
11	4	No	Yes	0.0	Passage	0.0	0	No	0	None	No	No	No
12	4	No	Yes	0.0	Passage	0.0	0	No	0	None	No	No	No
13	6	No	Yes	0.0	Passage	0.0	0	No	0	None	No	No	No
14	6	No	Yes	0.0	Passage	0.0	0	No	0	None	No	No	No
15	8	No	Yes	0.0	Passage	0.0	0	No	0	None	No	No	No
16	8	No	Yes	0.0	Passage	0.0	0	No	0	None	No	No	No
17	1	No	Yes	0.0	Passage	0.0	0	No	0	None	No	No	No
18	2	No	Yes	0.0	Passage	0.0	0	No	0	None	No	No	No
19	3	No	Yes	0.0	Passage	0.0	0	No	0	None	No	No	No
20	4	No	Yes	0.0	None	0.0	0	No	0	None	No	No	No
21	5	No	Yes	0.0	Passage	0.0	0	No	0	None	No	No	No
22	6	No	Yes	0.0	Passage	0.0	0	No	0	None	No	No	No
23	7	No	Yes	0.0	Passage	0.0	0	No	0	None	No	No	No
24	8	No	Yes	0.0	None	0.0	0	No	0	None	No	No	No
25	2	No	Yes	0.0	Passage	0.0	0	No	0	None	No	No	No
26	4	No	Yes	0.0	Passage	0.0	0	No	0	None	No	No	No
27	6	No	Yes	0.0	Passage	0.0	0	No	0	None	No	No	No
28	8	No	Yes	0.0	Passage	0.0	0	No	0	None	No	No	No
29	0	No	Yes	0.0	Passage	0.0	0	No	0	None	No	No	No
30	0	No	Yes	0.0	Passage	0.0	0	No	0	None	No	No	No
31	0	No	Yes	0.0	Passage	0.0	0	No	0	None	No	No	No
32	0	No	Yes	0.0	Passage	0.0	0	No	0	None	No	No	No
33	0	No	Yes	0.0	Passage	0.0	0	No	0	None	No	No	No
34	0	No	Yes	0.0	Passage	0.0	0	No	0	None	No	No	No
35	0	No	Yes	0.0	Passage	0.0	0	No	0	None	No	No	No
36	0	No	Yes	0.0	Passage	0.0	0	No	0	None	No	No	No
37	0	No	Yes	0.0	Passage	0.0	0	No	0	None	No	No	No
38	0	No	Yes	0.0	Passage	0.0	0	No	0	None	No	No	No
39	0	No	Yes	0.0	Passage	0.0	0	No	0	None	No	No	No
40	0	No	Yes	0.0	Passage	0.0	0	No	0	None	No	No	No
41	0	No	Yes	0.0	Passage	0.0	0	No	0	None	No	No	No
42	0	No	Yes	0.0	Passage	0.0	0	No	0	None	No	No	No
43	0	No	Yes	0.0	Passage	0.0	0	No	0	None	No	No	No
44	0	No	Yes	0.0	Passage	0.0	0	No	0	None	No	No	No
45	0	No	Yes	0.0	Passage	0.0	0	No	0	None	No	No	No
46	0	No	Yes	0.0	Passage	0.0	0	No	0	None	No	No	No
47	0	No	Yes	0.0	Passage	0.0	0	No	0	None	No	No	No
48	0	No	Yes	0.0	Passage	0.0	0	No	0	None	No	No	No
49	0	No	Yes	0.0	Passage	0.0	0	No	0	None	No	No	No
50	0	No	Yes	0.0	Passage	0.0	0	No	0	None	No	No	No
51	0	No	Yes	0.0	Passage	0.0	0	No	0	None	No	No	No
52	0	No	Yes	0.0	Passage	0.0	0	No	0	None	No	No	No
53	0	No	Yes	0.0	Passage	0.0	0	No	0	None	No	No	No
54	0	No	Yes	0.0	Passage	0.0	0	No	0	None	No	No	No
55	0	No	Yes	0.0	Passage	0.0	0	No	0	None	No	No	No
56	0	No	Yes	0.0	Passage	0.0	0	No	0	None	No	No	No

57	0	No	Yes	0.0	Passage	0.0	0	No	0	None	No	No	No
58	0	No	Yes	0.0	Passage	0.0	0	No	0	None	No	No	No
59	0	No	Yes	0.0	Passage	0.0	0	No	0	None	No	No	No
60	0	No	Yes	0.0	Passage	0.0	0	No	0	None	No	No	No
61	0	No	Yes	0.0	Passage	0.0	0	No	0	None	No	No	No
62	0	No	Yes	0.0	Passage	0.0	0	No	0	None	No	No	No
63	0	No	Yes	0.0	Passage	0.0	0	No	0	None	No	No	No
64	0	No	Yes	0.0	Passage	0.0	0	No	0	None	No	No	No

Vehicle Detector Plan Number - 4

Veh Detector	Phase	ECPI Log	Call Option	Delay Time	Ext Option	Extend Time / Passage Time	Queue Lim. / Discon. Time	Use Added Initial	Cross Switch Ph	Lock In	NTCIP Vol.	NTCIP Occ.	Pmt Queue Delay
1	1	No	Yes	0.0	Passage	0.0	0	No	0	None	No	No	No
2	2	No	Yes	0.0	Passage	0.0	0	No	0	None	No	No	No
3	3	No	Yes	0.0	Passage	0.0	0	No	0	None	No	No	No
4	4	No	Yes	0.0	None	0.0	0	No	0	None	No	No	No
5	5	No	Yes	0.0	Passage	0.0	0	No	0	None	No	No	No
6	6	No	Yes	0.0	Passage	0.0	0	No	0	None	No	No	No
7	7	No	Yes	0.0	Passage	0.0	0	No	0	None	No	No	No
8	8	No	Yes	0.0	None	0.0	0	No	0	None	No	No	No
9	2	No	Yes	0.0	Passage	0.0	0	No	0	None	No	No	No
10	2	No	Yes	0.0	Passage	0.0	0	No	0	None	No	No	No
11	4	No	Yes	0.0	Passage	0.0	0	No	0	None	No	No	No
12	4	No	Yes	0.0	Passage	0.0	0	No	0	None	No	No	No
13	6	No	Yes	0.0	Passage	0.0	0	No	0	None	No	No	No
14	6	No	Yes	0.0	Passage	0.0	0	No	0	None	No	No	No
15	8	No	Yes	0.0	Passage	0.0	0	No	0	None	No	No	No
16	8	No	Yes	0.0	Passage	0.0	0	No	0	None	No	No	No
17	1	No	Yes	0.0	Passage	0.0	0	No	0	None	No	No	No
18	2	No	Yes	0.0	Passage	0.0	0	No	0	None	No	No	No
19	3	No	Yes	0.0	Passage	0.0	0	No	0	None	No	No	No
20	4	No	Yes	0.0	None	0.0	0	No	0	None	No	No	No
21	5	No	Yes	0.0	Passage	0.0	0	No	0	None	No	No	No
22	6	No	Yes	0.0	Passage	0.0	0	No	0	None	No	No	No
23	7	No	Yes	0.0	Passage	0.0	0	No	0	None	No	No	No
24	8	No	Yes	0.0	None	0.0	0	No	0	None	No	No	No
25	2	No	Yes	0.0	Passage	0.0	0	No	0	None	No	No	No
26	4	No	Yes	0.0	Passage	0.0	0	No	0	None	No	No	No
27	6	No	Yes	0.0	Passage	0.0	0	No	0	None	No	No	No
28	8	No	Yes	0.0	Passage	0.0	0	No	0	None	No	No	No
29	0	No	Yes	0.0	Passage	0.0	0	No	0	None	No	No	No
30	0	No	Yes	0.0	Passage	0.0	0	No	0	None	No	No	No
31	0	No	Yes	0.0	Passage	0.0	0	No	0	None	No	No	No
32	0	No	Yes	0.0	Passage	0.0	0	No	0	None	No	No	No
33	0	No	Yes	0.0	Passage	0.0	0	No	0	None	No	No	No
34	0	No	Yes	0.0	Passage	0.0	0	No	0	None	No	No	No
35	0	No	Yes	0.0	Passage	0.0	0	No	0	None	No	No	No
36	0	No	Yes	0.0	Passage	0.0	0	No	0	None	No	No	No
37	0	No	Yes	0.0	Passage	0.0	0	No	0	None	No	No	No
38	0	No	Yes	0.0	Passage	0.0	0	No	0	None	No	No	No
39	0	No	Yes	0.0	Passage	0.0	0	No	0	None	No	No	No
40	0	No	Yes	0.0	Passage	0.0	0	No	0	None	No	No	No
41	0	No	Yes	0.0	Passage	0.0	0	No	0	None	No	No	No
42	0	No	Yes	0.0	Passage	0.0	0	No	0	None	No	No	No
43	0	No	Yes	0.0	Passage	0.0	0	No	0	None	No	No	No
44	0	No	Yes	0.0	Passage	0.0	0	No	0	None	No	No	No
45	0	No	Yes	0.0	Passage	0.0	0	No	0	None	No	No	No
46	0	No	Yes	0.0	Passage	0.0	0	No	0	None	No	No	No
47	0	No	Yes	0.0	Passage	0.0	0	No	0	None	No	No	No
48	0	No	Yes	0.0	Passage	0.0	0	No	0	None	No	No	No
49	0	No	Yes	0.0	Passage	0.0	0	No	0	None	No	No	No
50	0	No	Yes	0.0	Passage	0.0	0	No	0	None	No	No	No
51	0	No	Yes	0.0	Passage	0.0	0	No	0	None	No	No	No
52	0	No	Yes	0.0	Passage	0.0	0	No	0	None	No	No	No
53	0	No	Yes	0.0	Passage	0.0	0	No	0	None	No	No	No
54	0	No	Yes	0.0	Passage	0.0	0	No	0	None	No	No	No
55	0	No	Yes	0.0	Passage	0.0	0	No	0	None	No	No	No
56	0	No	Yes	0.0	Passage	0.0	0	No	0	None	No	No	No
57	0	No	Yes	0.0	Passage	0.0	0	No	0	None	No	No	No
58	0	No	Yes	0.0	Passage	0.0	0	No	0	None	No	No	No
59	0	No	Yes	0.0	Passage	0.0	0	No	0	None	No	No	No
60	0	No	Yes	0.0	Passage	0.0	0	No	0	None	No	No	No
61	0	No	Yes	0.0	Passage	0.0	0	No	0	None	No	No	No
62	0	No	Yes	0.0	Passage	0.0	0	No	0	None	No	No	No
63	0	No	Yes	0.0	Passage	0.0	0	No	0	None	No	No	No
64	0	No	Yes	0.0	Passage	0.0	0	No	0	None	No	No	No

Ped Detector Phase Assignment (MM) 6-3

Mode: Econolite

Ped Detector Number	Called Phase															
	1	2	3	4	5	6	7	8	9	10	11	12	13	14	15	16
1	X
2	.	X
3	.	.	X
4	.	.	.	X
5	X
6	X
7	X
8	X
9	X
10	X
11	X
12	X
13	X	.	.	.
14	X	.	.
15	X	.
16	X

Castle Rock, CO



Solutions that Move the World™

250 - Allen Way @ Allen St - Cobalt @ 10.50.60.64 - Econolite Type - Cobalt

Detectors

Detectors - Pg 2

Log - Speed Detector Setup (MM) 6-4

NTCIP Log Period: 60 ECPI Log Period: 0 Length Unit: Inches

Speed Detector	Local Detector	One/Two Detector	Vehicle Length	Trap length	Enable Log
1	0	1	0	0	No
2	0	1	0	0	No
3	0	1	0	0	No
4	0	1	0	0	No
5	0	1	0	0	No
6	0	1	0	0	No
7	0	1	0	0	No
8	0	1	0	0	No
9	0	1	0	0	No
10	0	1	0	0	No
11	0	1	0	0	No
12	0	1	0	0	No
13	0	1	0	0	No
14	0	1	0	0	No
15	0	1	0	0	No
16	0	1	0	0	No

Vehicle Detector Diagnostics (MM) 6-5

Veh Diagnostic Plan Number - 1

Det	Counts	Act	Pres	Multiplier	Failed Time	Failed Call Delay
1	0	0	60	1	255	0
2	0	7	1	60	255	0
5	0	0	60	1	255	0
6	0	7	1	60	255	0
17	0	0	1	60	255	0
18	0	7	1	60	255	0
22	0	0	1	60	255	0

Veh Diagnostic Plan Number - 2

Det	Counts	Act	Pres	Multiplier	Failed Time	Failed Call Delay
-----	--------	-----	------	------------	-------------	-------------------

Veh Diagnostic Plan Number - 3

Det	Counts	Act	Pres	Multiplier	Failed Time	Failed Call Delay
-----	--------	-----	------	------------	-------------	-------------------

Veh Diagnostic Plan Number - 4

Det	Counts	Act	Pres	Multiplier	Failed Time	Failed Call Delay
-----	--------	-----	------	------------	-------------	-------------------

Pedestrian Detector Diagnostics (MM) 6-6

Ped Diagnostic Plan Number - 1

Det	Counts	Act	Pres	Multiplier
2	0	168	1	60
4	0	168	1	60
6	0	168	1	60
8	0	168	1	60

Ped Diagnostic Plan Number - 2

Det	Counts	Act	Pres	Multiplier
-----	--------	-----	------	------------

Ped Diagnostic Plan Number - 3

Det	Counts	Act	Pres	Multiplier
-----	--------	-----	------	------------

Ped Diagnostic Plan Number - 4

Det	Counts	Act	Pres	Multiplier
-----	--------	-----	------	------------

APPENDIX B

Level of Service Definitions

The following information can be found in the Highway Capacity Manual, Transportation Research Board, 2016: Chapter 19 – Signalized Intersections and Chapter 20 – Two-Way Stop Controlled Intersections.

Automobile Level of Service (LOS) for Signalized Intersections

Levels of service are defined to represent reasonable ranges in control delay.

LOS A

Describes operations with a control delay of 10 s/veh or less and a volume-to-capacity ratio no greater than 1.0. This level is typically assigned when the volume-to-capacity ratio is low and either progression is exceptionally favorable or the cycle length is very short. If it is due to favorable progression, most vehicles arrive during the green indication and travel through the intersection without stopping.

LOS B

Describes operations with control delay between 10 and 20 s/veh and a volume-to-capacity ratio no greater than 1.0. This level is typically assigned when the volume-to-capacity ratio is low and either progression is highly favorable or the cycle length is short. More vehicles stop than with LOS A.

LOS C

Describes operations with control delay between 20 and 35 s/veh and a volume-to-capacity ratio no greater than 1.0. This level is typically assigned when progression is favorable or the cycle length is moderate. Individual *cycle failures* (i.e., one or more queued vehicles are not able to depart as a result of insufficient capacity during the cycle) may begin to appear at this level. The number of vehicles stopping is significant, although many vehicles still pass through the intersection without stopping.

LOS D

Describes operations with control delay between 35 and 55 s/veh and a volume-to-capacity ratio no greater than 1.0. This level is typically assigned when the volume-to-capacity ratio is high and either progression is ineffective or the cycle length is long. Many vehicles stop and individual cycle failures are noticeable.

LOS E

Describes operations with control delay between 55 and 80 s/veh and a volume-to-capacity ratio no greater than 1.0. This level is typically assigned when the volume-to-capacity ratio is high, progression is unfavorable, and the cycle length is long. Individual cycle failures are frequent.

LOS F

Describes operations with control delay exceeding 80 s/veh or a volume-to-capacity ratio greater than 1.0. This level is typically assigned when the volume-to-capacity ratio is very high, progression is very poor, and the cycle length is long. Most cycles fail to clear the queue.

Level of Service (LOS) for Unsignalized TWSC Intersections





























Level of Service (v/c ≤ 1.0)	Average Control Delay (s/veh)
A	0 - 10
B	> 10 - 15
C	> 15 - 25
D	> 25 - 35
E	> 35 - 50
F	> 50

APPENDIX C

Capacity Worksheets

Timings
1: Front Street & Founders Parkway (SH 86)

Existing Traffic Volumes
 AM Peak Hour

												
Lane Group	EBL	EBT	EBR	WBL	WBT	WBR	NBL	NBT	NBR	SBL	SBT	SBR
Lane Configurations	 		 		 			  			  	
Traffic Volume (vph)	171	37	35	15	23	57	56	1466	8	50	866	159
Future Volume (vph)	171	37	35	15	23	57	56	1466	8	50	866	159
Satd. Flow (prot)	3433	1863	1583	1770	3161	0	1770	5080	0	1770	4968	0
Flt Permitted	0.548			0.731			0.221			0.116		
Satd. Flow (perm)	1980	1863	1583	1362	3161	0	412	5080	0	216	4968	0
Satd. Flow (RTOR)			164		62			1			58	
Lane Group Flow (vph)	186	40	38	16	87	0	61	1602	0	54	1114	0
Turn Type	pm+pt	NA	Perm	pm+pt	NA		pm+pt	NA		pm+pt	NA	
Protected Phases	7	4		3	8		1	6		5	2	
Permitted Phases	4		4	8			6			2		
Detector Phase	7	4	4	3	8		1	6		5	2	
Switch Phase												
Minimum Initial (s)	3.0	5.0	5.0	3.0	5.0		3.0	20.0		3.0	20.0	
Minimum Split (s)	10.0	11.0	11.0	10.0	11.0		10.0	26.0		10.0	26.0	
Total Split (s)	11.0	12.0	12.0	18.0	19.0		10.0	80.0		10.0	80.0	
Total Split (%)	9.2%	10.0%	10.0%	15.0%	15.8%		8.3%	66.7%		8.3%	66.7%	
Yellow Time (s)	3.0	4.0	4.0	3.0	4.0		3.0	4.0		3.0	4.0	
All-Red Time (s)	2.0	2.0	2.0	2.0	2.0		2.0	2.0		2.0	2.0	
Lost Time Adjust (s)	0.0	0.0	0.0	0.0	0.0		0.0	0.0		0.0	0.0	
Total Lost Time (s)	5.0	6.0	6.0	5.0	6.0		5.0	6.0		5.0	6.0	
Lead/Lag	Lead	Lag	Lag	Lead	Lag		Lead	Lag		Lead	Lag	
Lead-Lag Optimize?	Yes	Yes	Yes	Yes	Yes		Yes	Yes		Yes	Yes	
Recall Mode	None	None	None	None	None		None	C-Max		None	C-Max	
Act Effct Green (s)	17.4	14.0	14.0	15.5	8.0		86.1	80.1		85.9	80.0	
Actuated g/C Ratio	0.14	0.12	0.12	0.13	0.07		0.72	0.67		0.72	0.67	
v/c Ratio	0.52	0.18	0.12	0.08	0.32		0.17	0.47		0.23	0.33	
Control Delay	49.7	52.0	0.7	41.3	22.6		5.5	11.0		6.9	9.0	
Queue Delay	0.0	0.0	0.0	0.0	0.0		0.0	0.0		0.0	0.0	
Total Delay	49.7	52.0	0.7	41.3	22.6		5.5	11.0		6.9	9.0	
LOS	D	D	A	D	C		A	B		A	A	
Approach Delay		43.0			25.5			10.8			8.9	
Approach LOS		D			C			B			A	
Queue Length 50th (ft)	67	27	0	11	10		10	206		9	119	
Queue Length 95th (ft)	96	65	0	30	35		25	276		23	165	
Internal Link Dist (ft)		695			413			423			624	
Turn Bay Length (ft)	285		285	195			175			455		
Base Capacity (vph)	360	218	330	271	397		364	3389		232	3330	
Starvation Cap Reductn	0	0	0	0	0		0	0		0	0	
Spillback Cap Reductn	0	0	0	0	0		0	0		0	0	
Storage Cap Reductn	0	0	0	0	0		0	0		0	0	
Reduced v/c Ratio	0.52	0.18	0.12	0.06	0.22		0.17	0.47		0.23	0.33	

Intersection Summary

Cycle Length: 120
 Actuated Cycle Length: 120
 Offset: 42 (35%), Referenced to phase 2:SBTL and 6:NBTL, Start of Green
 Natural Cycle: 60
 Control Type: Actuated-Coordinated

Timings

1: Front Street & Founders Parkway (SH 86)

Existing Traffic Volumes
AM Peak Hour

Maximum v/c Ratio: 0.52

Intersection Signal Delay: 13.2









Intersection LOS: B

Intersection Capacity Utilization 57.5%

ICU Level of Service B



























Analysis Period (min) 15

Splits and Phases: 1: Front Street & Founders Parkway (SH 86)

 Ø1	 Ø2 (R)	 Ø3	 Ø4
10 s	80 s	18 s	12 s
 Ø5	 Ø6 (R)	 Ø7	 Ø8
10 s	80 s	11 s	19 s

Timings
2: Allen Way & Founders Parkway (SH 86)

Existing Traffic Volumes
AM Peak Hour

												
Lane Group	EBL	EBT	EBR	WBL	WBT	WBR	NBL	NBT	NBR	SBL	SBT	SBR
Lane Configurations	 	  			  			 		 		
Traffic Volume (vph)	245	954	132	37	1539	131	94	18	52	63	12	287
Future Volume (vph)	245	954	132	37	1539	131	94	18	52	63	12	287
Satd. Flow (prot)	3433	4994	0	1770	5085	1583	1770	1656	0	1770	1863	2787
Flt Permitted	0.950			0.227			0.544			0.707		
Satd. Flow (perm)	3433	4994	0	423	5085	1583	1013	1656	0	1317	1863	2787
Satd. Flow (RTOR)		41				142		57				310
Lane Group Flow (vph)	266	1180	0	40	1673	142	102	77	0	68	13	312
Turn Type	Prot	NA		pm+pt	NA	Perm	pm+pt	NA		pm+pt	NA	Perm
Protected Phases	5	2		1	6		7	4		3	8	
Permitted Phases				6		6	4			8		8
Detector Phase	5	2		1	6	6	7	4		3	8	8
Switch Phase												
Minimum Initial (s)	5.0	20.0		5.0	20.0	20.0	5.0	5.0		5.0	5.0	5.0
Minimum Split (s)	10.0	26.0		10.0	26.0	26.0	10.0	11.0		11.0	11.0	11.0
Total Split (s)	15.0	83.0		11.0	79.0	79.0	13.0	12.0		14.0	13.0	13.0
Total Split (%)	12.5%	69.2%		9.2%	65.8%	65.8%	10.8%	10.0%		11.7%	10.8%	10.8%
Yellow Time (s)	3.0	4.0		3.0	4.0	4.0	3.0	4.0		3.0	4.0	4.0
All-Red Time (s)	2.0	2.0		2.0	2.0	2.0	2.0	2.0		2.0	2.0	2.0
Lost Time Adjust (s)	0.0	0.0		0.0	0.0	0.0	0.0	0.0		0.0	0.0	0.0
Total Lost Time (s)	5.0	6.0		5.0	6.0	6.0	5.0	6.0		5.0	6.0	6.0
Lead/Lag	Lead	Lead		Lag	Lag	Lag	Lead	Lag		Lead	Lag	Lag
Lead-Lag Optimize?	Yes	Yes		Yes	Yes	Yes	Yes	Yes		Yes	Yes	Yes
Recall Mode	None	C-Min		None	C-Min	C-Min	None	None		None	None	None
Act Effct Green (s)	14.0	65.4		66.4	65.4	65.4	22.2	11.3		17.8	7.3	7.3
Actuated g/C Ratio	0.12	0.54		0.55	0.54	0.54	0.18	0.09		0.15	0.06	0.06
v/c Ratio	0.67	0.43		0.09	0.60	0.15	0.40	0.37		0.29	0.12	0.68
Control Delay	62.4	18.9		16.1	20.3	2.9	43.5	24.6		44.5	60.3	18.6
Queue Delay	0.0	0.1		0.0	0.0	0.0	0.0	0.0		0.0	0.0	0.1
Total Delay	62.4	19.0		16.1	20.3	2.9	43.5	24.6		44.5	60.3	18.7
LOS	E	B		B	C	A	D	C		D	E	B
Approach Delay		26.9			18.9			35.4			24.5	
Approach LOS		C			B			D			C	
Queue Length 50th (ft)	102	214		14	314	0	68	15		46	10	0
Queue Length 95th (ft)	#195	244		33	382	31	110	61		87	32	59
Internal Link Dist (ft)		347			406			277			368	
Turn Bay Length (ft)	300			330			80			120		100
Base Capacity (vph)	399	3414		439	3093	1018	259	207		243	124	475
Starvation Cap Reductn	0	571		0	0	0	0	0		0	0	0
Spillback Cap Reductn	0	0		0	120	0	0	0		0	0	7
Storage Cap Reductn	0	0		0	0	0	0	0		0	0	0
Reduced v/c Ratio	0.67	0.42		0.09	0.56	0.14	0.39	0.37		0.28	0.10	0.67

Intersection Summary

Cycle Length: 120
 Actuated Cycle Length: 120
 Offset: 36 (30%), Referenced to phase 2:EBT and 6:WBTL, Start of Green
 Natural Cycle: 60
 Control Type: Actuated-Coordinated

Timings
2: Allen Way & Founders Parkway (SH 86)

Existing Traffic Volumes
 AM Peak Hour

Maximum v/c Ratio: 0.68

Intersection Signal Delay: 23.2

Intersection LOS: C

Intersection Capacity Utilization 62.8%

ICU Level of Service B

Analysis Period (min) 15

95th percentile volume exceeds capacity, queue may be longer.

Queue shown is maximum after two cycles.

Splits and Phases: 2: Allen Way & Founders Parkway (SH 86)

→ Ø2 (R)		↙ Ø1		↘ Ø3		↑ Ø4	
83 s		11 s		14 s		12 s	
↗ Ø5		↘ Ø6 (R)		↙ Ø7		↓ Ø8	
15 s		79 s		13 s		13 s	

Timings

Existing Traffic Volumes

3: I-25 NB Off-Ramp/I-25 NB On-Ramp & Founders Parkway (SH 86)

AM Peak Hour

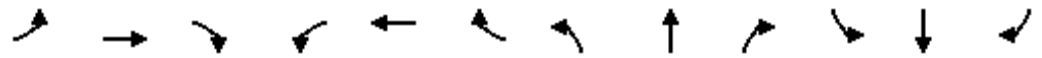

Lane Group	EBL	EBT	EBR	WBL	WBT	WBR	NBL	NBT	NBR	SBL	SBT	SBR
Lane Configurations		↑↑↑	↗		↑↑	↗	↖↖		↖↖			
Traffic Volume (vph)	0	972	528	0	740	1273	215	0	215	0	0	0
Future Volume (vph)	0	972	528	0	740	1273	215	0	215	0	0	0
Satd. Flow (prot)	0	4686	1362	0	3156	1441	3433	0	2787	0	0	0
Flt Permitted							0.950					
Satd. Flow (perm)	0	4686	1362	0	3156	1441	3433	0	2787	0	0	0
Satd. Flow (RTOR)		71	367		421	692			234			
Lane Group Flow (vph)	0	1264	367	0	1496	692	234	0	234	0	0	0
Turn Type		NA	Free		NA	Free	Prot		Prot			
Protected Phases		2			2		4		4			
Permitted Phases			Free			Free						
Detector Phase		2			2		4		4			
Switch Phase												
Minimum Initial (s)		20.0			20.0		5.0		5.0			
Minimum Split (s)		26.0			26.0		10.5		10.5			
Total Split (s)		89.0			89.0		31.0		31.0			
Total Split (%)		74.2%			74.2%		25.8%		25.8%			
Yellow Time (s)		4.0			4.0		3.5		3.5			
All-Red Time (s)		2.0			2.0		2.0		2.0			
Lost Time Adjust (s)		0.0			0.0		0.0		0.0			
Total Lost Time (s)		6.0			6.0		5.5		5.5			
Lead/Lag												
Lead-Lag Optimize?												
Recall Mode		C-Max			C-Max		None		None			
Act Effct Green (s)		95.0	120.0		95.0	120.0	13.5		13.5			
Actuated g/C Ratio		0.79	1.00		0.79	1.00	0.11		0.11			
v/c Ratio		0.34	0.27		0.58	0.48	0.61		0.45			
Control Delay		3.8	0.5		5.5	3.4	57.2		8.7			
Queue Delay		0.0	0.0		0.3	0.0	0.0		0.0			
Total Delay		3.8	0.5		5.9	3.4	57.2		8.7			
LOS		A	A		A	A	E		A			
Approach Delay		3.0			5.1			33.0				
Approach LOS		A			A			C				
Queue Length 50th (ft)		82	0		396	61	90		0			
Queue Length 95th (ft)		117	0		51	128	128		39			
Internal Link Dist (ft)		649			347			213			215	
Turn Bay Length (ft)			500						100			
Base Capacity (vph)		3724	1362		2586	1441	729		776			
Starvation Cap Reductn		0	0		474	0	0		0			
Spillback Cap Reductn		42	0		0	0	0		2			
Storage Cap Reductn		0	0		0	0	0		0			
Reduced v/c Ratio		0.34	0.27		0.71	0.48	0.32		0.30			

Intersection Summary

Cycle Length: 120
Actuated Cycle Length: 120
Offset: 35 (29%), Referenced to phase 2:EBWB, Start of Green
Natural Cycle: 40
Control Type: Actuated-Coordinated

Timings

Existing Traffic Volumes

3: I-25 NB Off-Ramp/I-25 NB On-Ramp & Founders Parkway (SH 86)

AM Peak Hour

Maximum v/c Ratio: 0.61

Intersection Signal Delay: 7.3

Intersection LOS: A

Intersection Capacity Utilization 48.5%

ICU Level of Service A

Analysis Period (min) 15























Splits and Phases: 3: I-25 NB Off-Ramp/I-25 NB On-Ramp & Founders Parkway (SH 86)

  Ø2 (R)	  Ø4
89 s	31 s

Timings

4: Allen Way & Allen Street

Existing Traffic Volumes
AM Peak Hour

												
Lane Group	EBL	EBT	EBR	WBL	WBT	WBR	NBL	NBT	NBR	SBL	SBT	SBR
Lane Configurations												
Traffic Volume (vph)	6	10	88	48	15	49	114	247	33	19	216	3
Future Volume (vph)	6	10	88	48	15	49	114	247	33	19	216	3
Satd. Flow (prot)	1770	1611	0	1770	1863	1583	1770	3539	1583	0	3518	0
Flt Permitted	0.433			0.688			0.592				0.925	
Satd. Flow (perm)	807	1611	0	1282	1863	1583	1103	3539	1583	0	3267	0
Satd. Flow (RTOR)		96				218			218		3	
Lane Group Flow (vph)	7	107	0	52	16	53	124	268	36	0	259	0
Turn Type	pm+pt	NA		Perm	NA	Perm	Perm	NA	Perm	D.P+P	NA	
Protected Phases	3	8			4			6		5	2	
Permitted Phases	8			4		4	6		6	6		
Detector Phase	3	8		4	4	4	6	6	6	5	2	
Switch Phase												
Minimum Initial (s)	3.0	5.0		5.0	5.0	5.0	5.0	5.0	5.0	3.0	5.0	
Minimum Split (s)	8.0	10.0		10.0	10.0	10.0	10.0	10.0	10.0	8.0	10.0	
Total Split (s)	12.0	27.0		15.0	15.0	15.0	21.0	21.0	21.0	12.0	33.0	
Total Split (%)	20.0%	45.0%		25.0%	25.0%	25.0%	35.0%	35.0%	35.0%	20.0%	55.0%	
Yellow Time (s)	3.0	3.0		3.0	3.0	3.0	3.0	3.0	3.0	3.0	3.0	
All-Red Time (s)	2.0	2.0		2.0	2.0	2.0	2.0	2.0	2.0	2.0	2.0	
Lost Time Adjust (s)	0.0	0.0		0.0	0.0	0.0	0.0	0.0	0.0		0.0	
Total Lost Time (s)	5.0	5.0		5.0	5.0	5.0	5.0	5.0	5.0		5.0	
Lead/Lag	Lead			Lag	Lag	Lag	Lag	Lag	Lag	Lead		
Lead-Lag Optimize?	Yes			Yes	Yes	Yes	Yes	Yes	Yes	Yes		
Recall Mode	None	None		None	None	None	C-Min	C-Min	C-Min	None	C-Min	
Act Effct Green (s)	10.2	10.2		8.0	8.0	8.0	42.9	42.9	42.9		42.9	
Actuated g/C Ratio	0.17	0.17		0.13	0.13	0.13	0.72	0.72	0.72		0.72	
v/c Ratio	0.03	0.30		0.31	0.06	0.13	0.16	0.11	0.03		0.11	
Control Delay	16.7	7.6		27.5	21.9	0.7	3.8	1.9	0.0		5.0	
Queue Delay	0.0	0.0		0.0	0.0	0.0	0.0	0.0	0.0		0.0	
Total Delay	16.7	7.6		27.5	21.9	0.7	3.8	1.9	0.0		5.0	
LOS	B	A		C	C	A	A	A	A		A	
Approach Delay		8.2			15.0			2.3			5.0	
Approach LOS		A			B			A			A	
Queue Length 50th (ft)	2	4		17	5	0	5	5	0		12	
Queue Length 95th (ft)	8	29		43	19	0	m30	22	m0		45	
Internal Link Dist (ft)		422			420			368			300	
Turn Bay Length (ft)	60			95		65	70		95			
Base Capacity (vph)	254	652		217	316	450	788	2530	1194		2337	
Starvation Cap Reductn	0	0		0	0	0	0	0	0		0	
Spillback Cap Reductn	0	0		0	0	0	0	0	0		0	
Storage Cap Reductn	0	0		0	0	0	0	0	0		0	
Reduced v/c Ratio	0.03	0.16		0.24	0.05	0.12	0.16	0.11	0.03		0.11	

Intersection Summary

Cycle Length: 60
 Actuated Cycle Length: 60
 Offset: 31 (52%), Referenced to phase 2:SBT and 6:NBSB, Start of Green
 Natural Cycle: 40
 Control Type: Actuated-Coordinated

Timings
4: Allen Way & Allen Street

Existing Traffic Volumes
 AM Peak Hour

Maximum v/c Ratio: 0.31

Intersection Signal Delay: 5.5

Intersection LOS: A

Intersection Capacity Utilization 35.3%

ICU Level of Service A

Analysis Period (min) 15

m Volume for 95th percentile queue is metered by upstream signal.

Splits and Phases: 4: Allen Way & Allen Street

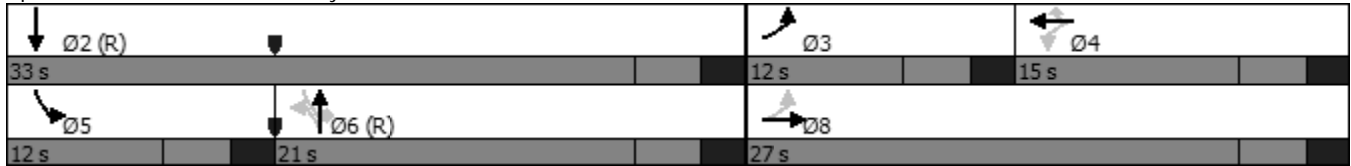

HCM 6th TWSC
5: Allen Street & Alexander Place

Existing Traffic Volumes
AM Peak Hour

Intersection												
Int Delay, s/veh	4.9											
Movement	EBL	EBT	EBR	WBL	WBT	WBR	NBL	NBT	NBR	SBL	SBT	SBR
Lane Configurations		↔		↵	↶		↵	↑	↶	↵	↶	
Traffic Vol, veh/h	26	1	17	22	1	66	22	69	38	25	31	14
Future Vol, veh/h	26	1	17	22	1	66	22	69	38	25	31	14
Conflicting Peds, #/hr	0	0	0	0	0	0	0	0	0	0	0	0
Sign Control	Stop	Stop	Stop	Stop	Stop	Stop	Free	Free	Free	Free	Free	Free
RT Channelized	-	-	None	-	-	None	-	-	None	-	-	None
Storage Length	-	-	-	60	-	-	75	-	75	80	-	-
Veh in Median Storage, #	-	0	-	-	0	-	-	0	-	-	0	-
Grade, %	-	0	-	-	0	-	-	0	-	-	0	-
Peak Hour Factor	92	92	92	92	92	92	92	92	92	92	92	92
Heavy Vehicles, %	2	2	2	2	2	2	2	2	2	2	2	2
Mvmt Flow	28	1	18	24	1	72	24	75	41	27	34	15

Major/Minor	Minor2		Minor1		Major1		Major2					
Conflicting Flow All	276	260	42	228	226	75	49	0	0	116	0	0
Stage 1	96	96	-	123	123	-	-	-	-	-	-	-
Stage 2	180	164	-	105	103	-	-	-	-	-	-	-
Critical Hdwy	7.12	6.52	6.22	7.12	6.52	6.22	4.12	-	-	4.12	-	-
Critical Hdwy Stg 1	6.12	5.52	-	6.12	5.52	-	-	-	-	-	-	-
Critical Hdwy Stg 2	6.12	5.52	-	6.12	5.52	-	-	-	-	-	-	-
Follow-up Hdwy	3.518	4.018	3.318	3.518	4.018	3.318	2.218	-	-	2.218	-	-
Pot Cap-1 Maneuver	676	645	1029	727	673	986	1558	-	-	1473	-	-
Stage 1	911	815	-	881	794	-	-	-	-	-	-	-
Stage 2	822	762	-	901	810	-	-	-	-	-	-	-
Platoon blocked, %	-	-	-	-	-	-	-	-	-	-	-	-
Mov Cap-1 Maneuver	610	624	1029	695	651	986	1558	-	-	1473	-	-
Mov Cap-2 Maneuver	610	624	-	695	651	-	-	-	-	-	-	-
Stage 1	897	800	-	868	782	-	-	-	-	-	-	-
Stage 2	749	751	-	867	795	-	-	-	-	-	-	-

Approach	EB		WB		NB		SB			
HCM Control Delay, s	10.3		9.3		1.3		2.7			
HCM LOS	B		A							

Minor Lane/Major Mvmt	NBL	NBT	NBR	EBLn1	WBLn1	WBLn2	SBL	SBT	SBR
Capacity (veh/h)	1558	-	-	724	695	978	1473	-	-
HCM Lane V/C Ratio	0.015	-	-	0.066	0.034	0.074	0.018	-	-
HCM Control Delay (s)	7.3	-	-	10.3	10.4	9	7.5	-	-
HCM Lane LOS	A	-	-	B	B	A	A	-	-
HCM 95th %tile Q(veh)	0	-	-	0.2	0.1	0.2	0.1	-	-

HCM 6th AWSC
6: Allen Street & Front Street

Existing Traffic Volumes
AM Peak Hour

Intersection	
Intersection Delay, s/veh	8.2
Intersection LOS	A

Movement	EBL	EBR	NBL	NBT	SBT	SBR
Lane Configurations	↙	↗	↙	↑	↑	↗
Traffic Vol, veh/h	56	38	52	87	57	40
Future Vol, veh/h	56	38	52	87	57	40
Peak Hour Factor	0.92	0.92	0.92	0.92	0.92	0.92
Heavy Vehicles, %	2	2	2	2	2	2
Mvmt Flow	61	41	57	95	62	43
Number of Lanes	1	1	1	1	1	1

Approach	EB	NB	SB
Opposing Approach		SB	NB
Opposing Lanes	0	2	2
Conflicting Approach Left	SB	EB	
Conflicting Lanes Left	2	2	0
Conflicting Approach Right	NB		EB
Conflicting Lanes Right	2	0	2
HCM Control Delay	8.4	8.4	7.7
HCM LOS	A	A	A

Lane	NBLn1	NBLn2	EBLn1	EBLn2	SBLn1	SBLn2
Vol Left, %	100%	0%	100%	0%	0%	0%
Vol Thru, %	0%	100%	0%	0%	100%	0%
Vol Right, %	0%	0%	0%	100%	0%	100%
Sign Control	Stop	Stop	Stop	Stop	Stop	Stop
Traffic Vol by Lane	52	87	56	38	57	40
LT Vol	52	0	56	0	0	0
Through Vol	0	87	0	0	57	0
RT Vol	0	0	0	38	0	40
Lane Flow Rate	57	95	61	41	62	43
Geometry Grp	7	7	7	7	7	7
Degree of Util (X)	0.085	0.128	0.096	0.051	0.085	0.051
Departure Headway (Hd)	5.392	4.89	5.649	4.446	4.941	4.238
Convergence, Y/N	Yes	Yes	Yes	Yes	Yes	Yes
Cap	666	736	636	807	727	847
Service Time	3.107	2.605	3.367	2.163	2.657	1.954
HCM Lane V/C Ratio	0.086	0.129	0.096	0.051	0.085	0.051
HCM Control Delay	8.6	8.3	9	7.4	8.1	7.2
HCM Lane LOS	A	A	A	A	A	A
HCM 95th-tile Q	0.3	0.4	0.3	0.2	0.3	0.2

HCM 6th TWSC
7: Private Access/Brewer Court & Alexander Place

Existing Traffic Volumes
AM Peak Hour

Intersection												
Int Delay, s/veh	5.7											
Movement	EBL	EBT	EBR	WBL	WBT	WBR	NBL	NBT	NBR	SBL	SBT	SBR
Lane Configurations	↕			↕			↕			↕		
Traffic Vol, veh/h	36	3	27	0	0	0	11	1	0	0	1	25
Future Vol, veh/h	36	3	27	0	0	0	11	1	0	0	1	25
Conflicting Peds, #/hr	0	0	0	0	0	0	0	0	0	0	0	0
Sign Control	Free	Free	Free	Free	Free	Free	Stop	Stop	Stop	Stop	Stop	Stop
RT Channelized	-	-	None	-	-	None	-	-	None	-	-	None
Storage Length	-	-	-	-	-	-	-	-	-	-	-	-
Veh in Median Storage, #	-	0	-	-	0	-	-	0	-	-	0	-
Grade, %	-	0	-	-	0	-	-	0	-	-	0	-
Peak Hour Factor	92	92	92	92	92	92	92	92	92	92	92	92
Heavy Vehicles, %	2	2	2	2	2	2	2	2	2	2	2	2
Mvmt Flow	39	3	29	0	0	0	12	1	0	0	1	27





























Major/Minor	Major1			Major2			Minor1			Minor2		
Conflicting Flow All	1	0	0	32	0	0	111	97	18	97	111	1
Stage 1	-	-	-	-	-	-	96	96	-	1	1	-
Stage 2	-	-	-	-	-	-	15	1	-	96	110	-
Critical Hdwy	4.12	-	-	4.12	-	-	7.12	6.52	6.22	7.12	6.52	6.22
Critical Hdwy Stg 1	-	-	-	-	-	-	6.12	5.52	-	6.12	5.52	-
Critical Hdwy Stg 2	-	-	-	-	-	-	6.12	5.52	-	6.12	5.52	-
Follow-up Hdwy	2.218	-	-	2.218	-	-	3.518	4.018	3.318	3.518	4.018	3.318
Pot Cap-1 Maneuver	1622	-	-	1580	-	-	867	793	1061	885	779	1084
Stage 1	-	-	-	-	-	-	911	815	-	1022	895	-
Stage 2	-	-	-	-	-	-	1005	895	-	911	804	-
Platoon blocked, %	-	-	-	-	-	-	-	-	-	-	-	-
Mov Cap-1 Maneuver	1622	-	-	1580	-	-	828	773	1061	867	760	1084
Mov Cap-2 Maneuver	-	-	-	-	-	-	828	773	-	867	760	-
Stage 1	-	-	-	-	-	-	888	795	-	996	895	-
Stage 2	-	-	-	-	-	-	979	895	-	887	784	-

Approach	EB			WB			NB			SB		
HCM Control Delay, s	4			0			9.4			8.5		
HCM LOS							A			A		

Minor Lane/Major Mvmt	NBLn1	EBL	EBT	EBR	WBL	WBT	WBR	SBLn1
Capacity (veh/h)	823	1622	-	-	1580	-	-	1067
HCM Lane V/C Ratio	0.016	0.024	-	-	-	-	-	0.026
HCM Control Delay (s)	9.4	7.3	0	-	0	-	-	8.5
HCM Lane LOS	A	A	A	-	A	-	-	A
HCM 95th %tile Q(veh)	0	0.1	-	-	0	-	-	0.1

Timings
1: Front Street & Founders Parkway (SH 86)

Existing Traffic Volumes
PM Peak Hour

												
Lane Group	EBL	EBT	EBR	WBL	WBT	WBR	NBL	NBT	NBR	SBL	SBT	SBR
Lane Configurations	 		 		 			  			  	
Traffic Volume (vph)	308	109	170	28	73	86	99	1332	11	158	1677	340
Future Volume (vph)	308	109	170	28	73	86	99	1332	11	158	1677	340
Satd. Flow (prot)	3433	1863	1583	1770	3253	0	1770	5080	0	1770	4958	0
Flt Permitted	0.462			0.681			0.055			0.130		
Satd. Flow (perm)	1670	1863	1583	1269	3253	0	102	5080	0	242	4958	0
Satd. Flow (RTOR)			168		93			2			72	
Lane Group Flow (vph)	335	118	185	30	172	0	108	1460	0	172	2193	0
Turn Type	pm+pt	NA	Perm	pm+pt	NA		pm+pt	NA		pm+pt	NA	
Protected Phases	7	4		3	8		1	6		5	2	
Permitted Phases	4		4	8			6			2		
Detector Phase	7	4	4	3	8		1	6		5	2	
Switch Phase												
Minimum Initial (s)	3.0	5.0	5.0	3.0	5.0		3.0	20.0		3.0	20.0	
Minimum Split (s)	10.0	11.0	11.0	10.0	11.0		10.0	26.0		10.0	26.0	
Total Split (s)	13.0	13.0	13.0	13.0	13.0		11.0	74.0		20.0	83.0	
Total Split (%)	10.8%	10.8%	10.8%	10.8%	10.8%		9.2%	61.7%		16.7%	69.2%	
Yellow Time (s)	3.0	4.0	4.0	3.0	4.0		3.0	4.0		3.0	4.0	
All-Red Time (s)	2.0	2.0	2.0	2.0	2.0		2.0	2.0		2.0	2.0	
Lost Time Adjust (s)	0.0	0.0	0.0	0.0	0.0		0.0	0.0		0.0	0.0	
Total Lost Time (s)	5.0	6.0	6.0	5.0	6.0		5.0	6.0		5.0	6.0	
Lead/Lag	Lead	Lag	Lag	Lead	Lag		Lead	Lag		Lead	Lag	
Lead-Lag Optimize?	Yes	Yes	Yes	Yes	Yes		Yes	Yes		Yes	Yes	
Recall Mode	None	None	None	None	None		None	C-Max		None	C-Max	
Act Effct Green (s)	17.9	12.1	12.1	14.7	6.7		81.1	74.1		87.1	77.3	
Actuated g/C Ratio	0.15	0.10	0.10	0.12	0.06		0.68	0.62		0.73	0.64	
v/c Ratio	0.92	0.63	0.60	0.16	0.64		0.71	0.47		0.59	0.68	
Control Delay	77.7	69.5	19.6	44.0	37.4		46.1	13.2		14.1	14.4	
Queue Delay	0.0	0.0	0.0	0.0	0.0		0.0	0.0		0.0	0.0	
Total Delay	77.7	69.5	19.6	44.0	37.4		46.1	13.2		14.1	14.4	
LOS	E	E	B	D	D		D	B		B	B	
Approach Delay		59.3			38.4			15.5			14.4	
Approach LOS		E			D			B			B	
Queue Length 50th (ft)	123	93	13	20	31		30	207		33	356	
Queue Length 95th (ft)	#185	#225	#113	48	69		#124	266		65	406	
Internal Link Dist (ft)		695			413			423			624	
Turn Bay Length (ft)	285		285	195			175			455		
Base Capacity (vph)	366	187	310	199	277		152	3136		371	3219	
Starvation Cap Reductn	0	0	0	0	0		0	0		0	0	
Spillback Cap Reductn	0	0	0	0	0		0	0		0	0	
Storage Cap Reductn	0	0	0	0	0		0	0		0	0	
Reduced v/c Ratio	0.92	0.63	0.60	0.15	0.62		0.71	0.47		0.46	0.68	

Intersection Summary

Cycle Length: 120
 Actuated Cycle Length: 120
 Offset: 112 (93%), Referenced to phase 2:SBTL and 6:NBTL, Start of Green
 Natural Cycle: 70
 Control Type: Actuated-Coordinated

Timings

1: Front Street & Founders Parkway (SH 86)

Existing Traffic Volumes
PM Peak Hour

Maximum v/c Ratio: 0.92

Intersection Signal Delay: 21.8

Intersection LOS: C

Intersection Capacity Utilization 77.4%









ICU Level of Service D

Analysis Period (min) 15

95th percentile volume exceeds capacity, queue may be longer.































Queue shown is maximum after two cycles.

Splits and Phases: 1: Front Street & Founders Parkway (SH 86)

 Ø1	 Ø2 (R)	 Ø3	 Ø4
11 s	83 s	13 s	13 s
 Ø5	 Ø6 (R)	 Ø7	 Ø8
20 s	74 s	13 s	13 s

Timings
2: Allen Way & Founders Parkway (SH 86)

Existing Traffic Volumes
PM Peak Hour

												
Lane Group	EBL	EBT	EBR	WBL	WBT	WBR	NBL	NBT	NBR	SBL	SBT	SBR
Lane Configurations	 	  			  			 			 	  
Traffic Volume (vph)	358	2091	238	46	1557	124	156	25	49	65	54	409
Future Volume (vph)	358	2091	238	46	1557	124	156	25	49	65	54	409
Satd. Flow (prot)	3433	5009	0	1770	5085	1583	1770	1678	0	1770	1863	2787
Flt Permitted	0.950			0.066			0.493			0.705		
Satd. Flow (perm)	3433	5009	0	123	5085	1583	918	1678	0	1313	1863	2787
Satd. Flow (RTOR)		32				135		53				382
Lane Group Flow (vph)	389	2532	0	50	1692	135	170	80	0	71	59	445
Turn Type	Prot	NA		pm+pt	NA	Perm	pm+pt	NA		pm+pt	NA	Perm
Protected Phases	5	2		1	6		7	4		3	8	
Permitted Phases				6		6	4			8		8
Detector Phase	5	2		1	6	6	7	4		3	8	8
Switch Phase												
Minimum Initial (s)	5.0	20.0		5.0	20.0	20.0	5.0	5.0		5.0	5.0	5.0
Minimum Split (s)	10.0	26.0		10.0	26.0	26.0	10.0	11.0		11.0	11.0	11.0
Total Split (s)	20.0	83.0		11.0	74.0	74.0	13.0	13.0		13.0	13.0	13.0
Total Split (%)	16.7%	69.2%		9.2%	61.7%	61.7%	10.8%	10.8%		10.8%	10.8%	10.8%
Yellow Time (s)	3.0	4.0		3.0	4.0	4.0	3.0	4.0		3.0	4.0	4.0
All-Red Time (s)	2.0	2.0		2.0	2.0	2.0	2.0	2.0		2.0	2.0	2.0
Lost Time Adjust (s)	0.0	0.0		0.0	0.0	0.0	0.0	0.0		0.0	0.0	0.0
Total Lost Time (s)	5.0	6.0		5.0	6.0	6.0	5.0	6.0		5.0	6.0	6.0
Lead/Lag	Lead	Lead		Lag	Lag	Lag	Lead	Lag		Lead	Lag	Lag
Lead-Lag Optimize?	Yes	Yes		Yes	Yes	Yes	Yes	Yes		Yes	Yes	Yes
Recall Mode	None	C-Min		None	C-Min	C-Min	None	None		None	None	None
Act Effct Green (s)	15.4	77.1		66.8	65.2	65.2	20.4	11.8		15.8	7.0	7.0
Actuated g/C Ratio	0.13	0.64		0.56	0.54	0.54	0.17	0.10		0.13	0.06	0.06
v/c Ratio	0.88	0.78		0.34	0.61	0.15	0.74	0.38		0.35	0.55	0.85
Control Delay	75.3	12.0		33.2	19.8	2.4	65.9	28.8		48.7	75.0	29.7
Queue Delay	0.0	0.7		0.0	0.0	0.0	0.0	0.0		0.0	0.0	0.1
Total Delay	75.3	12.7		33.2	19.8	2.4	65.9	28.8		48.7	75.0	29.8
LOS	E	B		C	B	A	E	C		D	E	C
Approach Delay		21.0			18.9			54.0			36.8	
Approach LOS		C			B			D			D	
Queue Length 50th (ft)	166	175		16	300	0	121	20		41	43	27
Queue Length 95th (ft)	#251	250		34	342	27	#221	72		m92	m#86	#110
Internal Link Dist (ft)		347			406			277			368	
Turn Bay Length (ft)	300			330			80			120		100
Base Capacity (vph)	441	3290		151	2881	955	229	212		207	111	526
Starvation Cap Reductn	0	384		0	0	0	0	0		0	0	0
Spillback Cap Reductn	0	0		0	27	0	0	0		0	0	2
Storage Cap Reductn	0	0		0	0	0	0	0		0	0	0
Reduced v/c Ratio	0.88	0.87		0.33	0.59	0.14	0.74	0.38		0.34	0.53	0.85

Intersection Summary

Cycle Length: 120
 Actuated Cycle Length: 120
 Offset: 107 (89%), Referenced to phase 2:EBT and 6:WBTL, Start of Green
 Natural Cycle: 80
 Control Type: Actuated-Coordinated

Timings
 2: Allen Way & Founders Parkway (SH 86)

Existing Traffic Volumes
 PM Peak Hour

Maximum v/c Ratio: 0.88

Intersection Signal Delay: 23.4

Intersection LOS: C

Intersection Capacity Utilization 79.3%

ICU Level of Service D

Analysis Period (min) 15

95th percentile volume exceeds capacity, queue may be longer.

Queue shown is maximum after two cycles.

m Volume for 95th percentile queue is metered by upstream signal.

Splits and Phases: 2: Allen Way & Founders Parkway (SH 86)

83 s				11 s		13 s		13 s	
20 s		74 s				13 s		13 s	

Timings

Existing Traffic Volumes

3: I-25 NB Off-Ramp/I-25 NB On-Ramp & Founders Parkway (SH 86)

PM Peak Hour

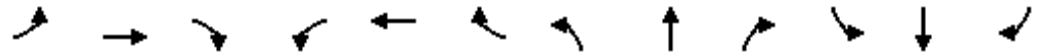

Lane Group	EBL	EBT	EBR	WBL	WBT	WBR	NBL	NBT	NBR	SBL	SBT	SBR
Lane Configurations		↑↑↑	↗		↑↑	↗	↖↖		↖↖			
Traffic Volume (vph)	0	2344	561	0	1174	958	398	0	350	0	0	0
Future Volume (vph)	0	2344	561	0	1174	958	398	0	350	0	0	0
Satd. Flow (prot)	0	4787	1362	0	3285	1441	3433	0	2787	0	0	0
Flt Permitted							0.950					
Satd. Flow (perm)	0	4787	1362	0	3285	1441	3433	0	2787	0	0	0
Satd. Flow (RTOR)		6	364		53	424			27			
Lane Group Flow (vph)	0	2609	549	0	1609	708	433	0	380	0	0	0
Turn Type		NA	Free		NA	Free	Prot		Prot			
Protected Phases		2			2		4		4			
Permitted Phases			Free			Free						
Detector Phase		2			2		4		4			
Switch Phase												
Minimum Initial (s)		20.0			20.0		5.0		5.0			
Minimum Split (s)		26.0			26.0		10.5		10.5			
Total Split (s)		85.0			85.0		35.0		35.0			
Total Split (%)		70.8%			70.8%		29.2%		29.2%			
Yellow Time (s)		4.0			4.0		3.5		3.5			
All-Red Time (s)		2.0			2.0		2.0		2.0			
Lost Time Adjust (s)		0.0			0.0		0.0		0.0			
Total Lost Time (s)		6.0			6.0		5.5		5.5			
Lead/Lag												
Lead-Lag Optimize?												
Recall Mode		C-Max			C-Max		None		None			
Act Effct Green (s)		87.4	120.0		87.4	120.0	21.1		21.1			
Actuated g/C Ratio		0.73	1.00		0.73	1.00	0.18		0.18			
v/c Ratio		0.75	0.40		0.67	0.49	0.72		0.74			
Control Delay		12.1	0.9		6.5	2.4	53.4		52.4			
Queue Delay		0.0	0.0		0.0	0.0	0.0		0.0			
Total Delay		12.1	0.9		6.6	2.4	53.4		52.4			
LOS		B	A		A	A	D		D			
Approach Delay		10.1			5.3			52.9				
Approach LOS		B			A			D				
Queue Length 50th (ft)		402	0		113	0	165		150			
Queue Length 95th (ft)		573	0		136	m416	207		196			
Internal Link Dist (ft)		649			347			213			215	
Turn Bay Length (ft)			500						100			
Base Capacity (vph)		3489	1362		2408	1441	843		705			
Starvation Cap Reductn		0	0		51	0	0		0			
Spillback Cap Reductn		0	0		0	0	0		0			
Storage Cap Reductn		0	0		0	0	0		0			
Reduced v/c Ratio		0.75	0.40		0.68	0.49	0.51		0.54			

Intersection Summary

Cycle Length: 120
 Actuated Cycle Length: 120
 Offset: 106 (88%), Referenced to phase 2:EBWB, Start of Green
 Natural Cycle: 60
 Control Type: Actuated-Coordinated

Timings

Existing Traffic Volumes

3: I-25 NB Off-Ramp/I-25 NB On-Ramp & Founders Parkway (SH 86)

PM Peak Hour

Maximum v/c Ratio: 0.75

Intersection Signal Delay: 13.9

Intersection LOS: B

Intersection Capacity Utilization 71.3%

ICU Level of Service C

Analysis Period (min) 15























m Volume for 95th percentile queue is metered by upstream signal.

Splits and Phases: 3: I-25 NB Off-Ramp/I-25 NB On-Ramp & Founders Parkway (SH 86)

 Ø2 (R)	 Ø4
85 s	35 s

Timings
4: Allen Way & Allen Street

Existing Traffic Volumes
PM Peak Hour

												
Lane Group	EBL	EBT	EBR	WBL	WBT	WBR	NBL	NBT	NBR	SBL	SBT	SBR
Lane Configurations												
Traffic Volume (vph)	1	57	84	144	22	41	144	311	73	13	341	9
Future Volume (vph)	1	57	84	144	22	41	144	311	73	13	341	9
Satd. Flow (prot)	1770	1697	0	1770	1863	1583	1770	3539	1583	0	3518	0
Flt Permitted	0.526			0.660			0.519				0.941	
Satd. Flow (perm)	980	1697	0	1229	1863	1583	967	3539	1583	0	3317	0
Satd. Flow (RTOR)		91					218		218		6	
Lane Group Flow (vph)	1	153	0	157	24	45	157	338	79	0	395	0
Turn Type	pm+pt	NA		Perm	NA	Perm	Perm	NA	Perm	D.P+P	NA	
Protected Phases	3	8			4			6		5	2	
Permitted Phases	8			4		4	6		6	6		
Detector Phase	3	8		4	4	4	6	6	6	5	2	
Switch Phase												
Minimum Initial (s)	3.0	5.0		5.0	5.0	5.0	5.0	5.0	5.0	3.0	5.0	
Minimum Split (s)	8.0	10.0		10.0	10.0	10.0	10.0	10.0	10.0	8.0	10.0	
Total Split (s)	12.0	27.0		15.0	15.0	15.0	21.0	21.0	21.0	12.0	33.0	
Total Split (%)	20.0%	45.0%		25.0%	25.0%	25.0%	35.0%	35.0%	35.0%	20.0%	55.0%	
Yellow Time (s)	3.0	3.0		3.0	3.0	3.0	3.0	3.0	3.0	3.0	3.0	
All-Red Time (s)	2.0	2.0		2.0	2.0	2.0	2.0	2.0	2.0	2.0	2.0	
Lost Time Adjust (s)	0.0	0.0		0.0	0.0	0.0	0.0	0.0	0.0		0.0	
Total Lost Time (s)	5.0	5.0		5.0	5.0	5.0	5.0	5.0	5.0		5.0	
Lead/Lag	Lead			Lag	Lag	Lag	Lag	Lag	Lag	Lead		
Lead-Lag Optimize?	Yes			Yes	Yes	Yes	Yes	Yes	Yes	Yes		
Recall Mode	None	None		None	None	None	C-Min	C-Min	C-Min	None	C-Min	
Act Effct Green (s)	14.4	14.4		12.2	12.2	12.2	35.6	35.6	35.6		35.6	
Actuated g/C Ratio	0.24	0.24		0.20	0.20	0.20	0.59	0.59	0.59		0.59	
v/c Ratio	0.00	0.32		0.63	0.06	0.09	0.27	0.16	0.08		0.20	
Control Delay	14.0	9.4		35.5	19.2	0.4	16.4	11.7	3.8		6.9	
Queue Delay	0.0	0.0		0.0	0.0	0.0	0.0	0.0	0.0		0.0	
Total Delay	14.0	9.4		35.5	19.2	0.4	16.4	11.7	3.8		6.9	
LOS	B	A		D	B	A	B	B	A		A	
Approach Delay		9.5			26.7			11.9			6.9	
Approach LOS		A			C			B			A	
Queue Length 50th (ft)	0	18		50	7	0	81	89	11		28	
Queue Length 95th (ft)	3	47		#132	24	0	m83	m76	m4		66	
Internal Link Dist (ft)		422			420			368			300	
Turn Bay Length (ft)	60			95		65	70		95			
Base Capacity (vph)	326	679		257	389	503	574	2102	1029		1972	
Starvation Cap Reductn	0	0		0	0	0	0	0	0		0	
Spillback Cap Reductn	0	0		0	0	0	0	0	0		0	
Storage Cap Reductn	0	0		0	0	0	0	0	0		0	
Reduced v/c Ratio	0.00	0.23		0.61	0.06	0.09	0.27	0.16	0.08		0.20	

Intersection Summary

Cycle Length: 60
 Actuated Cycle Length: 60
 Offset: 31 (52%), Referenced to phase 2:SBT and 6:NBSB, Start of Green
 Natural Cycle: 60
 Control Type: Actuated-Coordinated

Timings
4: Allen Way & Allen Street

Existing Traffic Volumes
 PM Peak Hour

Maximum v/c Ratio: 0.63

Intersection Signal Delay: 12.6

Intersection LOS: B

Intersection Capacity Utilization 51.5%

ICU Level of Service A

Analysis Period (min) 15

95th percentile volume exceeds capacity, queue may be longer.

Queue shown is maximum after two cycles.

m Volume for 95th percentile queue is metered by upstream signal.

Splits and Phases: 4: Allen Way & Allen Street

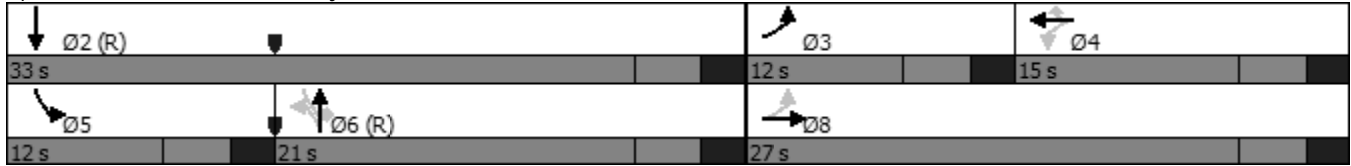

HCM 6th TWSC
5: Allen Street & Alexander Place

Existing Traffic Volumes
PM Peak Hour

Intersection												
Int Delay, s/veh	6.1											
Movement	EBL	EBT	EBR	WBL	WBT	WBR	NBL	NBT	NBR	SBL	SBT	SBR
Lane Configurations		↔		↵	↶		↵	↑	↶	↵	↶	
Traffic Vol, veh/h	56	10	50	82	6	51	55	101	85	30	97	16
Future Vol, veh/h	56	10	50	82	6	51	55	101	85	30	97	16
Conflicting Peds, #/hr	0	0	0	0	0	0	0	0	0	0	0	0
Sign Control	Stop	Stop	Stop	Stop	Stop	Stop	Free	Free	Free	Free	Free	Free
RT Channelized	-	-	None	-	-	None	-	-	None	-	-	None
Storage Length	-	-	-	60	-	-	75	-	75	80	-	-
Veh in Median Storage, #	-	0	-	-	0	-	-	0	-	-	0	-
Grade, %	-	0	-	-	0	-	-	0	-	-	0	-
Peak Hour Factor	92	92	92	92	92	92	92	92	92	92	92	92
Heavy Vehicles, %	2	2	2	2	2	2	2	2	2	2	2	2
Mvmt Flow	61	11	54	89	7	55	60	110	92	33	105	17

Major/Minor	Minor2		Minor1		Major1		Major2					
Conflicting Flow All	487	502	114	442	418	110	122	0	0	202	0	0
Stage 1	180	180	-	230	230	-	-	-	-	-	-	-
Stage 2	307	322	-	212	188	-	-	-	-	-	-	-
Critical Hdwy	7.12	6.52	6.22	7.12	6.52	6.22	4.12	-	-	4.12	-	-
Critical Hdwy Stg 1	6.12	5.52	-	6.12	5.52	-	-	-	-	-	-	-
Critical Hdwy Stg 2	6.12	5.52	-	6.12	5.52	-	-	-	-	-	-	-
Follow-up Hdwy	3.518	4.018	3.318	3.518	4.018	3.318	2.218	-	-	2.218	-	-
Pot Cap-1 Maneuver	491	471	939	526	526	943	1465	-	-	1370	-	-
Stage 1	822	750	-	773	714	-	-	-	-	-	-	-
Stage 2	703	651	-	790	745	-	-	-	-	-	-	-
Platoon blocked, %								-	-	-	-	-
Mov Cap-1 Maneuver	435	441	939	462	492	943	1465	-	-	1370	-	-
Mov Cap-2 Maneuver	435	441	-	462	492	-	-	-	-	-	-	-
Stage 1	788	732	-	741	685	-	-	-	-	-	-	-
Stage 2	629	624	-	716	727	-	-	-	-	-	-	-

Approach	EB		WB		NB		SB	
HCM Control Delay, s	13.2		12.5		1.7		1.6	
HCM LOS	B		B					

Minor Lane/Major Mvmt	NBL	NBT	NBR	EBLn1	WBLn1	WBLn2	SBL	SBT	SBR
Capacity (veh/h)	1465	-	-	567	462	860	1370	-	-
HCM Lane V/C Ratio	0.041	-	-	0.222	0.193	0.072	0.024	-	-
HCM Control Delay (s)	7.6	-	-	13.2	14.6	9.5	7.7	-	-
HCM Lane LOS	A	-	-	B	B	A	A	-	-
HCM 95th %tile Q(veh)	0.1	-	-	0.8	0.7	0.2	0.1	-	-

HCM 6th AWSC
6: Allen Street & Front Street

Existing Traffic Volumes
PM Peak Hour

Intersection	
Intersection Delay, s/veh	10.2
Intersection LOS	B

Movement	EBL	EBR	NBL	NBT	SBT	SBR
Lane Configurations	↙	↗	↙	↑	↑	↗
Traffic Vol, veh/h	160	124	77	143	143	107
Future Vol, veh/h	160	124	77	143	143	107
Peak Hour Factor	0.92	0.92	0.92	0.92	0.92	0.92
Heavy Vehicles, %	2	2	2	2	2	2
Mvmt Flow	174	135	84	155	155	116
Number of Lanes	1	1	1	1	1	1

Approach	EB	NB	SB
Opposing Approach		SB	NB
Opposing Lanes	0	2	2
Conflicting Approach Left	SB	EB	
Conflicting Lanes Left	2	2	0
Conflicting Approach Right	NB		EB
Conflicting Lanes Right	2	0	2
HCM Control Delay	10.6	10.2	9.6
HCM LOS	B	B	A

Lane	NBLn1	NBLn2	EBLn1	EBLn2	SBLn1	SBLn2
Vol Left, %	100%	0%	100%	0%	0%	0%
Vol Thru, %	0%	100%	0%	0%	100%	0%
Vol Right, %	0%	0%	0%	100%	0%	100%
Sign Control	Stop	Stop	Stop	Stop	Stop	Stop
Traffic Vol by Lane	77	143	160	124	143	107
LT Vol	77	0	160	0	0	0
Through Vol	0	143	0	0	143	0
RT Vol	0	0	0	124	0	107
Lane Flow Rate	84	155	174	135	155	116
Geometry Grp	7	7	7	7	7	7
Degree of Util (X)	0.144	0.245	0.303	0.19	0.245	0.16
Departure Headway (Hd)	6.181	5.675	6.281	5.073	5.666	4.959
Convergence, Y/N	Yes	Yes	Yes	Yes	Yes	Yes
Cap	575	626	567	698	628	714
Service Time	3.978	3.472	4.079	2.87	3.459	2.751
HCM Lane V/C Ratio	0.146	0.248	0.307	0.193	0.247	0.162
HCM Control Delay	10	10.3	11.8	9.1	10.3	8.7
HCM Lane LOS	A	B	B	A	B	A
HCM 95th-tile Q	0.5	1	1.3	0.7	1	0.6

HCM 6th TWSC
7: Private Access/Brewer Court & Alexander Place

Existing Traffic Volumes
PM Peak Hour

Intersection												
Int Delay, s/veh	8.1											
Movement	EBL	EBT	EBR	WBL	WBT	WBR	NBL	NBT	NBR	SBL	SBT	SBR
Lane Configurations	↕			↕			↕			↕		
Traffic Vol, veh/h	108	2	6	0	6	0	19	1	0	0	1	123
Future Vol, veh/h	108	2	6	0	6	0	19	1	0	0	1	123
Conflicting Peds, #/hr	0	0	0	0	0	0	0	0	0	0	0	0
Sign Control	Free	Free	Free	Free	Free	Free	Stop	Stop	Stop	Stop	Stop	Stop
RT Channelized	-	-	None	-	-	None	-	-	None	-	-	None
Storage Length	-	-	-	-	-	-	-	-	-	-	-	-
Veh in Median Storage, #	-	0	-	-	0	-	-	0	-	-	0	-
Grade, %	-	0	-	-	0	-	-	0	-	-	0	-
Peak Hour Factor	92	92	92	92	92	92	92	92	92	92	92	92
Heavy Vehicles, %	2	2	2	2	2	2	2	2	2	2	2	2
Mvmt Flow	117	2	7	0	7	0	21	1	0	0	1	134





























Major/Minor	Major1			Major2			Minor1			Minor2		
Conflicting Flow All	7	0	0	9	0	0	315	247	6	247	250	7
Stage 1	-	-	-	-	-	-	240	240	-	7	7	-
Stage 2	-	-	-	-	-	-	75	7	-	240	243	-
Critical Hdwy	4.12	-	-	4.12	-	-	7.12	6.52	6.22	7.12	6.52	6.22
Critical Hdwy Stg 1	-	-	-	-	-	-	6.12	5.52	-	6.12	5.52	-
Critical Hdwy Stg 2	-	-	-	-	-	-	6.12	5.52	-	6.12	5.52	-
Follow-up Hdwy	2.218	-	-	2.218	-	-	3.518	4.018	3.318	3.518	4.018	3.318
Pot Cap-1 Maneuver	1614	-	-	1611	-	-	638	655	1077	707	653	1075
Stage 1	-	-	-	-	-	-	763	707	-	1015	890	-
Stage 2	-	-	-	-	-	-	934	890	-	763	705	-
Platoon blocked, %	-	-	-	-	-	-	-	-	-	-	-	-
Mov Cap-1 Maneuver	1614	-	-	1611	-	-	527	607	1077	667	605	1075
Mov Cap-2 Maneuver	-	-	-	-	-	-	527	607	-	667	605	-
Stage 1	-	-	-	-	-	-	707	655	-	941	890	-
Stage 2	-	-	-	-	-	-	817	890	-	706	654	-

Approach	EB			WB			NB			SB		
HCM Control Delay, s	6.9			0			12.1			8.9		
HCM LOS							B			A		

Minor Lane/Major Mvmt	NBLn1	EBL	EBT	EBR	WBL	WBT	WBR	SBLn1
Capacity (veh/h)	530	1614	-	-	1611	-	-	1068
HCM Lane V/C Ratio	0.041	0.073	-	-	-	-	-	0.126
HCM Control Delay (s)	12.1	7.4	0	-	0	-	-	8.9
HCM Lane LOS	B	A	A	-	A	-	-	A
HCM 95th %tile Q(veh)	0.1	0.2	-	-	0	-	-	0.4

Timings
1: Front Street & Founders Parkway (SH 86)

Existing Traffic Volumes
Saturday Peak Hour

												
Lane Group	EBL	EBT	EBR	WBL	WBT	WBR	NBL	NBT	NBR	SBL	SBT	SBR
Lane Configurations	 		 		 			  			  	
Traffic Volume (vph)	334	101	139	43	112	89	109	1493	36	153	1363	378
Future Volume (vph)	334	101	139	43	112	89	109	1493	36	153	1363	378
Satd. Flow (prot)	3433	1863	1583	1770	3306	0	1770	5065	0	1770	4917	0
Flt Permitted	0.463			0.686			0.083			0.080		
Satd. Flow (perm)	1673	1863	1583	1278	3306	0	155	5065	0	149	4917	0
Satd. Flow (RTOR)			196		97			5			98	
Lane Group Flow (vph)	363	110	151	47	219	0	118	1662	0	166	1893	0
Turn Type	pm+pt	NA	Perm	pm+pt	NA		pm+pt	NA		pm+pt	NA	
Protected Phases	7	4		3	8		1	6		5	2	
Permitted Phases	4		4	8			6			2		
Detector Phase	7	4	4	3	8		1	6		5	2	
Switch Phase												
Minimum Initial (s)	3.0	5.0	5.0	3.0	5.0		3.0	20.0		3.0	20.0	
Minimum Split (s)	10.0	11.0	11.0	10.0	11.0		10.0	26.0		10.0	26.0	
Total Split (s)	14.0	13.0	13.0	20.0	19.0		12.0	52.0		15.0	55.0	
Total Split (%)	14.0%	13.0%	13.0%	20.0%	19.0%		12.0%	52.0%		15.0%	55.0%	
Yellow Time (s)	3.0	4.0	4.0	3.0	4.0		3.0	4.0		3.0	4.0	
All-Red Time (s)	2.0	2.0	2.0	2.0	2.0		2.0	2.0		2.0	2.0	
Lost Time Adjust (s)	0.0	0.0	0.0	0.0	0.0		0.0	0.0		0.0	0.0	
Total Lost Time (s)	5.0	6.0	6.0	5.0	6.0		5.0	6.0		5.0	6.0	
Lead/Lag	Lead	Lag	Lag	Lead	Lag		Lead	Lag		Lead	Lag	
Lead-Lag Optimize?	Yes	Yes	Yes	Yes	Yes		Yes	Yes		Yes	Yes	
Recall Mode	None	None	None	None	None		None	C-Max		None	C-Max	
Act Effct Green (s)	22.3	15.9	15.9	18.6	10.1		57.9	49.9		61.9	51.9	
Actuated g/C Ratio	0.22	0.16	0.16	0.19	0.10		0.58	0.50		0.62	0.52	
v/c Ratio	0.68	0.37	0.36	0.17	0.52		0.58	0.66		0.70	0.73	
Control Delay	38.8	43.3	5.1	29.3	27.4		26.2	20.9		32.9	20.1	
Queue Delay	0.0	0.0	0.0	0.0	0.0		0.0	0.0		0.0	0.0	
Total Delay	38.8	43.3	5.1	29.3	27.4		26.2	20.9		32.9	20.1	
LOS	D	D	A	C	C		C	C		C	C	
Approach Delay		31.4			27.8			21.2			21.1	
Approach LOS		C			C			C			C	
Queue Length 50th (ft)	98	66	0	23	38		26	290		48	324	
Queue Length 95th (ft)	137	122	29	51	74		#89	357		#133	394	
Internal Link Dist (ft)		695			413			423			624	
Turn Bay Length (ft)	285		285	195			175			455		
Base Capacity (vph)	532	297	417	394	514		206	2528		256	2598	
Starvation Cap Reductn	0	0	0	0	0		0	0		0	0	
Spillback Cap Reductn	0	0	0	0	0		0	0		0	0	
Storage Cap Reductn	0	0	0	0	0		0	0		0	0	
Reduced v/c Ratio	0.68	0.37	0.36	0.12	0.43		0.57	0.66		0.65	0.73	

Intersection Summary

Cycle Length: 100
 Actuated Cycle Length: 100
 Offset: 62 (62%), Referenced to phase 2:SBTL and 6:NBTL, Start of Green
 Natural Cycle: 60
 Control Type: Actuated-Coordinated

Timings
1: Front Street & Founders Parkway (SH 86)

Existing Traffic Volumes
 Saturday Peak Hour

Maximum v/c Ratio: 0.73

Intersection Signal Delay: 22.9

Intersection LOS: C

Intersection Capacity Utilization 74.6%









ICU Level of Service D

Analysis Period (min) 15

95th percentile volume exceeds capacity, queue may be longer.































Queue shown is maximum after two cycles.

Splits and Phases: 1: Front Street & Founders Parkway (SH 86)

 Ø1	 Ø2 (R)	 Ø3	 Ø4
12 s	55 s	20 s	13 s
 Ø5	 Ø6 (R)	 Ø7	 Ø8
15 s	52 s	14 s	19 s

Timings
2: Allen Way & Founders Parkway (SH 86)

Existing Traffic Volumes
Saturday Peak Hour

												
Lane Group	EBL	EBT	EBR	WBL	WBT	WBR	NBL	NBT	NBR	SBL	SBT	SBR
Lane Configurations	 	  			  			 			 	  
Traffic Volume (vph)	448	1676	217	43	1670	194	181	34	86	134	36	492
Future Volume (vph)	448	1676	217	43	1670	194	181	34	86	134	36	492
Satd. Flow (prot)	3433	4999	0	1770	5085	1583	1770	1663	0	1770	1863	2787
Flt Permitted	0.950			0.098			0.637			0.655		
Satd. Flow (perm)	3433	4999	0	183	5085	1583	1187	1663	0	1220	1863	2787
Satd. Flow (RTOR)		34				211		93				535
Lane Group Flow (vph)	487	2058	0	47	1815	211	197	130	0	146	39	535
Turn Type	Prot	NA		pm+pt	NA	Perm	pm+pt	NA		pm+pt	NA	Perm
Protected Phases	5	2		1	6		7	4		3	8	
Permitted Phases				6		6	4			8		8
Detector Phase	5	2		1	6	6	7	4		3	8	8
Switch Phase												
Minimum Initial (s)	5.0	20.0		5.0	20.0	20.0	5.0	5.0		5.0	5.0	5.0
Minimum Split (s)	10.0	26.0		10.0	26.0	26.0	10.0	11.0		11.0	11.0	11.0
Total Split (s)	20.0	58.0		11.0	49.0	49.0	18.0	13.0		18.0	13.0	13.0
Total Split (%)	20.0%	58.0%		11.0%	49.0%	49.0%	18.0%	13.0%		18.0%	13.0%	13.0%
Yellow Time (s)	3.0	4.0		3.0	4.0	4.0	3.0	4.0		3.0	4.0	4.0
All-Red Time (s)	2.0	2.0		2.0	2.0	2.0	2.0	2.0		2.0	2.0	2.0
Lost Time Adjust (s)	0.0	0.0		0.0	0.0	0.0	0.0	0.0		0.0	0.0	0.0
Total Lost Time (s)	5.0	6.0		5.0	6.0	6.0	5.0	6.0		5.0	6.0	6.0
Lead/Lag	Lead	Lead		Lag	Lag	Lag	Lead	Lag		Lead	Lag	Lag
Lead-Lag Optimize?	Yes	Yes		Yes	Yes	Yes	Yes	Yes		Yes	Yes	Yes
Recall Mode	None	C-Min		None	C-Min	C-Min	None	None		None	None	None
Act Effct Green (s)	15.5	57.4		44.6	43.6	43.6	21.0	7.7		18.9	6.6	6.6
Actuated g/C Ratio	0.16	0.57		0.45	0.44	0.44	0.21	0.08		0.19	0.07	0.07
v/c Ratio	0.92	0.71		0.27	0.82	0.26	0.62	0.61		0.50	0.32	0.78
Control Delay	62.6	19.8		29.9	28.8	3.4	40.8	29.3		36.9	51.4	13.1
Queue Delay	0.0	1.0		0.0	2.0	0.0	0.0	0.0		0.0	0.0	0.6
Total Delay	62.6	20.8		29.9	30.8	3.4	40.8	29.3		36.9	51.4	13.7
LOS	E	C		C	C	A	D	C		D	D	B
Approach Delay		28.8			28.0			36.2			20.5	
Approach LOS		C			C			D			C	
Queue Length 50th (ft)	158	339		17	366	0	105	23		75	24	0
Queue Length 95th (ft)	#263	440		38	432	41	172	#97		131	58	55
Internal Link Dist (ft)		347			406			277			368	
Turn Bay Length (ft)	300			330			80			120		100
Base Capacity (vph)	532	2887		177	2216	808	332	213		322	130	692
Starvation Cap Reductn	0	525		0	0	0	0	0		0	0	0
Spillback Cap Reductn	0	0		0	253	0	0	0		0	0	26
Storage Cap Reductn	0	0		0	0	0	0	0		0	0	0
Reduced v/c Ratio	0.92	0.87		0.27	0.92	0.26	0.59	0.61		0.45	0.30	0.80

Intersection Summary

Cycle Length: 100
 Actuated Cycle Length: 100
 Offset: 70 (70%), Referenced to phase 2:EBT and 6:WBTL, Start of Green
 Natural Cycle: 70
 Control Type: Actuated-Coordinated

Timings
2: Allen Way & Founders Parkway (SH 86)

Existing Traffic Volumes
 Saturday Peak Hour

Maximum v/c Ratio: 0.92
 Intersection Signal Delay: 27.9
 Intersection Capacity Utilization 75.9%
 Analysis Period (min) 15
 # 95th percentile volume exceeds capacity, queue may be longer.
 Queue shown is maximum after two cycles.

Splits and Phases: 2: Allen Way & Founders Parkway (SH 86)

→ Ø2 (R) 58 s	↓	↙ Ø1 11 s	↘ Ø3 18 s	↕ Ø4 13 s
↗ Ø5 20 s	↖ Ø6 (R) 49 s	↙ Ø7 18 s	↘ Ø8 13 s	

Timings

Existing Traffic Volumes

3: I-25 NB Off-Ramp/I-25 NB On-Ramp & Founders Parkway (SH 86)

Saturday Peak Hour

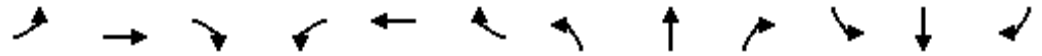

Lane Group	EBL	EBT	EBR	WBL	WBT	WBR	NBL	NBT	NBR	SBL	SBT	SBR
Lane Configurations		↑↑↑	↗		↑↑	↗	↖↖		↖↖			
Traffic Volume (vph)	0	1963	496	0	1331	1015	511	0	381	0	0	0
Future Volume (vph)	0	1963	496	0	1331	1015	511	0	381	0	0	0
Satd. Flow (prot)	0	4787	1362	0	3299	1441	3433	0	2787	0	0	0
Flt Permitted							0.950					
Satd. Flow (perm)	0	4787	1362	0	3299	1441	3433	0	2787	0	0	0
Satd. Flow (RTOR)		6	462		47	476			33			
Lane Group Flow (vph)	0	2188	485	0	1767	783	555	0	414	0	0	0
Turn Type		NA	Free		NA	Free	Prot		Prot			
Protected Phases		2			2		4		4			
Permitted Phases			Free			Free						
Detector Phase		2			2		4		4			
Switch Phase												
Minimum Initial (s)		20.0			20.0		5.0		5.0			
Minimum Split (s)		26.0			26.0		10.5		10.5			
Total Split (s)		68.0			68.0		32.0		32.0			
Total Split (%)		68.0%			68.0%		32.0%		32.0%			
Yellow Time (s)		4.0			4.0		3.5		3.5			
All-Red Time (s)		2.0			2.0		2.0		2.0			
Lost Time Adjust (s)		0.0			0.0		0.0		0.0			
Total Lost Time (s)		6.0			6.0		5.5		5.5			
Lead/Lag												
Lead-Lag Optimize?												
Recall Mode		C-Max			C-Max		None		None			
Act Effct Green (s)		66.7	100.0		66.7	100.0	21.8		21.8			
Actuated g/C Ratio		0.67	1.00		0.67	1.00	0.22		0.22			
v/c Ratio		0.69	0.36		0.80	0.54	0.74		0.65			
Control Delay		12.2	0.7		9.5	3.7	42.6		37.4			
Queue Delay		0.0	0.0		12.6	0.0	0.0		1.8			
Total Delay		12.2	0.7		22.2	3.7	42.6		39.2			
LOS		B	A		C	A	D		D			
Approach Delay		10.1			16.5			41.2				
Approach LOS		B			B			D				
Queue Length 50th (ft)		298	0		537	208	170		126			
Queue Length 95th (ft)		408	0		687	361	215		172			
Internal Link Dist (ft)		649			347			213			215	
Turn Bay Length (ft)			500						100			
Base Capacity (vph)		3194	1362		2215	1441	909		762			
Starvation Cap Reductn		0	0		461	0	0		0			
Spillback Cap Reductn		68	0		0	0	0		202			
Storage Cap Reductn		0	0		0	0	0		0			
Reduced v/c Ratio		0.70	0.36		1.01	0.54	0.61		0.74			

Intersection Summary

Cycle Length: 100
 Actuated Cycle Length: 100
 Offset: 80 (80%), Referenced to phase 2:EBWB, Start of Green
 Natural Cycle: 60
 Control Type: Actuated-Coordinated

Timings

Existing Traffic Volumes

3: I-25 NB Off-Ramp/I-25 NB On-Ramp & Founders Parkway (SH 86)

Saturday Peak Hour

Maximum v/c Ratio: 0.80

Intersection Signal Delay: 17.6

Intersection LOS: B

Intersection Capacity Utilization 70.5%

ICU Level of Service C























Analysis Period (min) 15

Splits and Phases: 3: I-25 NB Off-Ramp/I-25 NB On-Ramp & Founders Parkway (SH 86)

  Ø2 (R)	  Ø4
68 s	32 s

Timings
4: Allen Way & Allen Street

Existing Traffic Volumes
Saturday Peak Hour

												
Lane Group	EBL	EBT	EBR	WBL	WBT	WBR	NBL	NBT	NBR	SBL	SBT	SBR
Lane Configurations												
Traffic Volume (vph)	9	51	133	126	52	65	152	376	71	52	348	3
Future Volume (vph)	9	51	133	126	52	65	152	376	71	52	348	3
Satd. Flow (prot)	1770	1660	0	1770	1863	1583	1770	3539	1583	0	3514	0
Flt Permitted	0.498			0.632			0.498				0.861	
Satd. Flow (perm)	928	1660	0	1177	1863	1583	928	3539	1583	0	3044	0
Satd. Flow (RTOR)		145				218			218		1	
Lane Group Flow (vph)	10	200	0	137	57	71	165	409	77	0	438	0
Turn Type	pm+pt	NA		Perm	NA	Perm	Perm	NA	Perm	D.P+P	NA	
Protected Phases	3	8			4			6		5	2	
Permitted Phases	8			4		4	6		6	6		
Detector Phase	3	8		4	4	4	6	6	6	5	2	
Switch Phase												
Minimum Initial (s)	3.0	5.0		5.0	5.0	5.0	5.0	5.0	5.0	3.0	5.0	
Minimum Split (s)	8.0	10.0		10.0	10.0	10.0	10.0	10.0	10.0	8.0	10.0	
Total Split (s)	12.0	27.0		15.0	15.0	15.0	21.0	21.0	21.0	12.0	33.0	
Total Split (%)	20.0%	45.0%		25.0%	25.0%	25.0%	35.0%	35.0%	35.0%	20.0%	55.0%	
Yellow Time (s)	3.0	3.0		3.0	3.0	3.0	3.0	3.0	3.0	3.0	3.0	
All-Red Time (s)	2.0	2.0		2.0	2.0	2.0	2.0	2.0	2.0	2.0	2.0	
Lost Time Adjust (s)	0.0	0.0		0.0	0.0	0.0	0.0	0.0	0.0		0.0	
Total Lost Time (s)	5.0	5.0		5.0	5.0	5.0	5.0	5.0	5.0		5.0	
Lead/Lag	Lead			Lag	Lag	Lag	Lag	Lag	Lag	Lead		
Lead-Lag Optimize?	Yes			Yes	Yes	Yes	Yes	Yes	Yes	Yes		
Recall Mode	None	None		None	None	None	C-Min	C-Min	C-Min	None	C-Min	
Act Effct Green (s)	13.5	13.5		11.2	11.2	11.2	36.5	36.5	36.5		36.5	
Actuated g/C Ratio	0.22	0.22		0.19	0.19	0.19	0.61	0.61	0.61		0.61	
v/c Ratio	0.03	0.41		0.62	0.16	0.15	0.29	0.19	0.07		0.24	
Control Delay	14.9	8.4		37.2	21.0	0.7	9.2	6.6	0.1		6.9	
Queue Delay	0.0	0.0		0.0	0.0	0.0	0.0	0.0	0.0		0.0	
Total Delay	14.9	8.4		37.2	21.0	0.7	9.2	6.6	0.1		6.9	
LOS	B	A		D	C	A	A	A	A		A	
Approach Delay		8.7			24.0			6.5			6.9	
Approach LOS		A			C			A			A	
Queue Length 50th (ft)	3	16		44	17	0	23	28	0		31	
Queue Length 95th (ft)	10	50		#119	45	0	78	68	0		76	
Internal Link Dist (ft)		422			420			368			300	
Turn Bay Length (ft)	60			95		65	70		95			
Base Capacity (vph)	307	700		231	365	486	564	2151	1048		1851	
Starvation Cap Reductn	0	0		0	0	0	0	0	0		0	
Spillback Cap Reductn	0	0		0	0	0	0	0	0		0	
Storage Cap Reductn	0	0		0	0	0	0	0	0		0	
Reduced v/c Ratio	0.03	0.29		0.59	0.16	0.15	0.29	0.19	0.07		0.24	

Intersection Summary

Cycle Length: 60
 Actuated Cycle Length: 60
 Offset: 31 (52%), Referenced to phase 2:SBT and 6:NBSB, Start of Green
 Natural Cycle: 60
 Control Type: Actuated-Coordinated

Timings
4: Allen Way & Allen Street

Existing Traffic Volumes
 Saturday Peak Hour

Maximum v/c Ratio: 0.62
 Intersection Signal Delay: 9.9
 Intersection Capacity Utilization 56.1%
 Analysis Period (min) 15
 # 95th percentile volume exceeds capacity, queue may be longer.
 Queue shown is maximum after two cycles.

Splits and Phases: 4: Allen Way & Allen Street

↓ Ø2 (R)	↑ Ø6 (R)	↘ Ø3	← Ø4
33 s	21 s	12 s	15 s
↙ Ø5	↓ Ø6 (R)	↗ Ø8	
12 s	21 s	27 s	

HCM 6th TWSC
5: Allen Street & Alexander Place

Existing Traffic Volumes
Saturday Peak Hour

Intersection												
Int Delay, s/veh	6.7											
Movement	EBL	EBT	EBR	WBL	WBT	WBR	NBL	NBT	NBR	SBL	SBT	SBR
Lane Configurations		↔		↵	↶		↵	↶	↷	↵	↶	
Traffic Vol, veh/h	74	2	47	121	5	33	55	130	95	34	129	25
Future Vol, veh/h	74	2	47	121	5	33	55	130	95	34	129	25
Conflicting Peds, #/hr	0	0	0	0	0	0	0	0	0	0	0	0
Sign Control	Stop	Stop	Stop	Stop	Stop	Stop	Free	Free	Free	Free	Free	Free
RT Channelized	-	-	None	-	-	None	-	-	None	-	-	None
Storage Length	-	-	-	60	-	-	75	-	75	80	-	-
Veh in Median Storage, #	-	0	-	-	0	-	-	0	-	-	0	-
Grade, %	-	0	-	-	0	-	-	0	-	-	0	-
Peak Hour Factor	92	92	92	92	92	92	92	92	92	92	92	92
Heavy Vehicles, %	2	2	2	2	2	2	2	2	2	2	2	2
Mvmt Flow	80	2	51	132	5	36	60	141	103	37	140	27

Major/Minor	Minor2		Minor1		Major1		Major2					
Conflicting Flow All	561	592	154	515	502	141	167	0	0	244	0	0
Stage 1	228	228	-	261	261	-	-	-	-	-	-	-
Stage 2	333	364	-	254	241	-	-	-	-	-	-	-
Critical Hdwy	7.12	6.52	6.22	7.12	6.52	6.22	4.12	-	-	4.12	-	-
Critical Hdwy Stg 1	6.12	5.52	-	6.12	5.52	-	-	-	-	-	-	-
Critical Hdwy Stg 2	6.12	5.52	-	6.12	5.52	-	-	-	-	-	-	-
Follow-up Hdwy	3.518	4.018	3.318	3.518	4.018	3.318	2.218	-	-	2.218	-	-
Pot Cap-1 Maneuver	438	419	892	470	471	907	1411	-	-	1322	-	-
Stage 1	775	715	-	744	692	-	-	-	-	-	-	-
Stage 2	681	624	-	750	706	-	-	-	-	-	-	-
Platoon blocked, %								-	-	-	-	-
Mov Cap-1 Maneuver	395	390	892	418	438	907	1411	-	-	1322	-	-
Mov Cap-2 Maneuver	395	390	-	418	438	-	-	-	-	-	-	-
Stage 1	742	695	-	712	662	-	-	-	-	-	-	-
Stage 2	621	597	-	685	686	-	-	-	-	-	-	-

Approach	EB		WB		NB		SB	
HCM Control Delay, s	14.8		15.7		1.5		1.4	
HCM LOS	B		C					

Minor Lane/Major Mvmt	NBL	NBT	NBR	EBLn1	WBLn1	WBLn2	SBL	SBT	SBR
Capacity (veh/h)	1411	-	-	502	418	795	1322	-	-
HCM Lane V/C Ratio	0.042	-	-	0.266	0.315	0.052	0.028	-	-
HCM Control Delay (s)	7.7	-	-	14.8	17.5	9.8	7.8	-	-
HCM Lane LOS	A	-	-	B	C	A	A	-	-
HCM 95th %tile Q(veh)	0.1	-	-	1.1	1.3	0.2	0.1	-	-

HCM 6th AWSC
6: Allen Street & Front Street

Existing Traffic Volumes
Saturday Peak Hour

Intersection	
Intersection Delay, s/veh	11.1
Intersection LOS	B

Movement	EBL	EBR	NBL	NBT	SBT	SBR
Lane Configurations	↙	↗	↙	↑	↑	↗
Traffic Vol, veh/h	191	95	79	167	159	170
Future Vol, veh/h	191	95	79	167	159	170
Peak Hour Factor	0.92	0.92	0.92	0.92	0.92	0.92
Heavy Vehicles, %	2	2	2	2	2	2
Mvmt Flow	208	103	86	182	173	185
Number of Lanes	1	1	1	1	1	1

Approach	EB	NB	SB
Opposing Approach		SB	NB
Opposing Lanes	0	2	2
Conflicting Approach Left	SB	EB	
Conflicting Lanes Left	2	2	0
Conflicting Approach Right	NB		EB
Conflicting Lanes Right	2	0	2
HCM Control Delay	12.1	10.9	10.3
HCM LOS	B	B	B

Lane	NBLn1	NBLn2	EBLn1	EBLn2	SBLn1	SBLn2
Vol Left, %	100%	0%	100%	0%	0%	0%
Vol Thru, %	0%	100%	0%	0%	100%	0%
Vol Right, %	0%	0%	0%	100%	0%	100%
Sign Control	Stop	Stop	Stop	Stop	Stop	Stop
Traffic Vol by Lane	79	167	191	95	159	170
LT Vol	79	0	191	0	0	0
Through Vol	0	167	0	0	159	0
RT Vol	0	0	0	95	0	170
Lane Flow Rate	86	182	208	103	173	185
Geometry Grp	7	7	7	7	7	7
Degree of Util (X)	0.154	0.301	0.383	0.156	0.282	0.266
Departure Headway (Hd)	6.468	5.961	6.647	5.436	5.884	5.175
Convergence, Y/N	Yes	Yes	Yes	Yes	Yes	Yes
Cap	556	604	542	660	612	695
Service Time	4.198	3.691	4.376	3.165	3.613	2.904
HCM Lane V/C Ratio	0.155	0.301	0.384	0.156	0.283	0.266
HCM Control Delay	10.4	11.2	13.5	9.2	10.9	9.8
HCM Lane LOS	B	B	B	A	B	A
HCM 95th-tile Q	0.5	1.3	1.8	0.6	1.2	1.1

HCM 6th TWSC
7: Private Access/Brewer Court & Alexander Place

Existing Traffic Volumes
Saturday Peak Hour

Intersection												
Int Delay, s/veh	8.2											
Movement	EBL	EBT	EBR	WBL	WBT	WBR	NBL	NBT	NBR	SBL	SBT	SBR
Lane Configurations	↕			↕			↕			↕		
Traffic Vol, veh/h	137	0	3	0	1	0	2	0	0	0	0	158
Future Vol, veh/h	137	0	3	0	1	0	2	0	0	0	0	158
Conflicting Peds, #/hr	0	0	0	0	0	0	0	0	0	0	0	0
Sign Control	Free	Free	Free	Free	Free	Free	Stop	Stop	Stop	Stop	Stop	Stop
RT Channelized	-	-	None	-	-	None	-	-	None	-	-	None
Storage Length	-	-	-	-	-	-	-	-	-	-	-	-
Veh in Median Storage, #	-	0	-	-	0	-	-	0	-	-	0	-
Grade, %	-	0	-	-	0	-	-	0	-	-	0	-
Peak Hour Factor	92	92	92	92	92	92	92	92	92	92	92	92
Heavy Vehicles, %	2	2	2	2	2	2	2	2	2	2	2	2
Mvmt Flow	149	0	3	0	1	0	2	0	0	0	0	172































Major/Minor	Major1		Major2		Minor1		Minor2					
Conflicting Flow All	1	0	0	3	0	0	387	301	2	301	302	1
Stage 1	-	-	-	-	-	-	300	300	-	1	1	-
Stage 2	-	-	-	-	-	-	87	1	-	300	301	-
Critical Hdwy	4.12	-	-	4.12	-	-	7.12	6.52	6.22	7.12	6.52	6.22
Critical Hdwy Stg 1	-	-	-	-	-	-	6.12	5.52	-	6.12	5.52	-
Critical Hdwy Stg 2	-	-	-	-	-	-	6.12	5.52	-	6.12	5.52	-
Follow-up Hdwy	2.218	-	-	2.218	-	-	3.518	4.018	3.318	3.518	4.018	3.318
Pot Cap-1 Maneuver	1622	-	-	1619	-	-	572	612	1082	651	611	1084
Stage 1	-	-	-	-	-	-	709	666	-	1022	895	-
Stage 2	-	-	-	-	-	-	921	895	-	709	665	-
Platoon blocked, %	-	-	-	-	-	-	-	-	-	-	-	-
Mov Cap-1 Maneuver	1622	-	-	1619	-	-	447	556	1082	605	555	1084
Mov Cap-2 Maneuver	-	-	-	-	-	-	447	556	-	605	555	-
Stage 1	-	-	-	-	-	-	644	605	-	928	895	-
Stage 2	-	-	-	-	-	-	775	895	-	644	604	-

Approach	EB	WB	NB	SB
HCM Control Delay, s	7.3	0	13.1	8.9
HCM LOS			B	A

Minor Lane/Major Mvmt	NBLn1	EBL	EBT	EBR	WBL	WBT	WBR	SBLn1
Capacity (veh/h)	447	1622	-	-	1619	-	-	1084
HCM Lane V/C Ratio	0.005	0.092	-	-	-	-	-	0.158
HCM Control Delay (s)	13.1	7.4	0	-	0	-	-	8.9
HCM Lane LOS	B	A	A	-	A	-	-	A
HCM 95th %tile Q(veh)	0	0.3	-	-	0	-	-	0.6

Timings
1: Front Street & Founders Parkway (SH 86)

Background Traffic Volumes
 Year 2023 - AM Peak Hour

												
Lane Group	EBL	EBT	EBR	WBL	WBT	WBR	NBL	NBT	NBR	SBL	SBT	SBR
Lane Configurations	 		 	 	 		 	  		 	 	
Traffic Volume (vph)	178	40	37	17	25	60	59	1526	9	53	901	166
Future Volume (vph)	178	40	37	17	25	60	59	1526	9	53	901	166
Satd. Flow (prot)	3433	1863	1583	1770	3164	0	1770	5080	0	1770	4968	0
Flt Permitted	0.547			0.729			0.209			0.106		
Satd. Flow (perm)	1977	1863	1583	1358	3164	0	389	5080	0	197	4968	0
Satd. Flow (RTOR)			164		65			1			57	
Lane Group Flow (vph)	193	43	40	18	92	0	64	1669	0	58	1159	0
Turn Type	pm+pt	NA	Perm	pm+pt	NA		pm+pt	NA		pm+pt	NA	
Protected Phases	7	4		3	8		1	6		5	2	
Permitted Phases	4		4	8			6			2		
Detector Phase	7	4	4	3	8		1	6		5	2	
Switch Phase												
Minimum Initial (s)	3.0	5.0	5.0	3.0	5.0		3.0	20.0		3.0	20.0	
Minimum Split (s)	10.0	11.0	11.0	10.0	11.0		10.0	26.0		10.0	26.0	
Total Split (s)	11.0	12.0	12.0	18.0	19.0		10.0	80.0		10.0	80.0	
Total Split (%)	9.2%	10.0%	10.0%	15.0%	15.8%		8.3%	66.7%		8.3%	66.7%	
Yellow Time (s)	3.0	4.0	4.0	3.0	4.0		3.0	4.0		3.0	4.0	
All-Red Time (s)	2.0	2.0	2.0	2.0	2.0		2.0	2.0		2.0	2.0	
Lost Time Adjust (s)	0.0	0.0	0.0	0.0	0.0		0.0	0.0		0.0	0.0	
Total Lost Time (s)	5.0	6.0	6.0	5.0	6.0		5.0	6.0		5.0	6.0	
Lead/Lag	Lead	Lag	Lag	Lead	Lag		Lead	Lag		Lead	Lag	
Lead-Lag Optimize?	Yes	Yes	Yes	Yes	Yes		Yes	Yes		Yes	Yes	
Recall Mode	None	None	None	None	None		None	C-Max		None	C-Max	
Act Effct Green (s)	17.5	14.1	14.1	15.8	8.2		85.9	79.9		85.8	79.9	
Actuated g/C Ratio	0.15	0.12	0.12	0.13	0.07		0.72	0.67		0.72	0.67	
v/c Ratio	0.53	0.20	0.12	0.09	0.33		0.18	0.49		0.26	0.35	
Control Delay	50.1	52.1	0.8	41.2	22.5		5.8	11.3		7.6	9.2	
Queue Delay	0.0	0.0	0.0	0.0	0.0		0.0	0.0		0.0	0.0	
Total Delay	50.1	52.1	0.8	41.2	22.5		5.8	11.3		7.6	9.2	
LOS	D	D	A	D	C		A	B		A	A	
Approach Delay		43.2			25.6			11.1			9.1	
Approach LOS		D			C			B			A	
Queue Length 50th (ft)	70	30	0	12	10		10	220		9	126	
Queue Length 95th (ft)	99	69	0	32	36		26	291		25	173	
Internal Link Dist (ft)		695			413			423			624	
Turn Bay Length (ft)	285		285	195			175			455		
Base Capacity (vph)	361	219	331	272	400		348	3384		219	3326	
Starvation Cap Reductn	0	0	0	0	0		0	0		0	0	
Spillback Cap Reductn	0	0	0	0	0		0	0		0	0	
Storage Cap Reductn	0	0	0	0	0		0	0		0	0	
Reduced v/c Ratio	0.53	0.20	0.12	0.07	0.23		0.18	0.49		0.26	0.35	

Intersection Summary

Cycle Length: 120
 Actuated Cycle Length: 120
 Offset: 42 (35%), Referenced to phase 2:SBTL and 6:NBTL, Start of Green
 Natural Cycle: 60
 Control Type: Actuated-Coordinated

Timings









1: Front Street & Founders Parkway (SH 86)

Background Traffic Volumes

Year 2023 - AM Peak Hour

Maximum v/c Ratio: 0.53	
Intersection Signal Delay: 13.5	Intersection LOS: B
Intersection Capacity Utilization 58.9%	ICU Level of Service B
Analysis Period (min) 15	

Splits and Phases: 1: Front Street & Founders Parkway (SH 86)

 Ø1	 Ø2 (R)	 Ø3	 Ø4
10 s	80 s	18 s	12 s
 Ø5	 Ø6 (R)	 Ø7	 Ø8
10 s	80 s	11 s	19 s

Timings
2: Allen Way & Founders Parkway (SH 86)

Background Traffic Volumes
 Year 2023 - AM Peak Hour

Lane Group	EBL	EBT	EBR	WBL	WBT	WBR	NBL	NBT	NBR	SBL	SBT	SBR
Lane Configurations												
Traffic Volume (vph)	256	993	138	39	1602	137	96	20	55	66	14	303
Future Volume (vph)	256	993	138	39	1602	137	96	20	55	66	14	303
Satd. Flow (prot)	3433	4994	0	1770	5085	1583	1770	1658	0	1770	1863	2787
Flt Permitted	0.950			0.216			0.548			0.704		
Satd. Flow (perm)	3433	4994	0	402	5085	1583	1021	1658	0	1311	1863	2787
Satd. Flow (RTOR)		42				149		60				304
Lane Group Flow (vph)	278	1229	0	42	1741	149	104	82	0	72	15	329
Turn Type	Prot	NA		pm+pt	NA	Perm	pm+pt	NA		pm+pt	NA	Perm
Protected Phases	5	2		1	6		7	4		3	8	
Permitted Phases				6		6	4			8		8
Detector Phase	5	2		1	6	6	7	4		3	8	8
Switch Phase												
Minimum Initial (s)	5.0	20.0		5.0	20.0	20.0	5.0	5.0		5.0	5.0	5.0
Minimum Split (s)	10.0	26.0		10.0	26.0	26.0	10.0	11.0		11.0	11.0	11.0
Total Split (s)	15.0	83.0		11.0	79.0	79.0	13.0	12.0		14.0	13.0	13.0
Total Split (%)	12.5%	69.2%		9.2%	65.8%	65.8%	10.8%	10.0%		11.7%	10.8%	10.8%
Yellow Time (s)	3.0	4.0		3.0	4.0	4.0	3.0	4.0		3.0	4.0	4.0
All-Red Time (s)	2.0	2.0		2.0	2.0	2.0	2.0	2.0		2.0	2.0	2.0
Lost Time Adjust (s)	0.0	0.0		0.0	0.0	0.0	0.0	0.0		0.0	0.0	0.0
Total Lost Time (s)	5.0	6.0		5.0	6.0	6.0	5.0	6.0		5.0	6.0	6.0
Lead/Lag	Lead	Lead		Lag	Lag	Lag	Lead	Lag		Lead	Lag	Lag
Lead-Lag Optimize?	Yes	Yes		Yes	Yes	Yes	Yes	Yes		Yes	Yes	Yes
Recall Mode	None	C-Min		None	C-Min	C-Min	None	None		None	None	None
Act Effct Green (s)	14.7	65.3		66.2	65.2	65.2	21.4	10.5		17.5	6.7	6.7
Actuated g/C Ratio	0.12	0.54		0.55	0.54	0.54	0.18	0.09		0.15	0.06	0.06
v/c Ratio	0.66	0.45		0.10	0.63	0.16	0.41	0.41		0.32	0.15	0.74
Control Delay	62.6	18.8		15.8	20.7	2.6	44.9	26.5		44.7	60.7	23.2
Queue Delay	0.0	0.1		0.0	0.0	0.0	0.0	0.0		0.0	0.0	0.0
Total Delay	62.6	18.8		15.8	20.7	2.6	44.9	26.5		44.7	60.7	23.2
LOS	E	B		B	C	A	D	C		D	E	C
Approach Delay		26.9			19.2			36.8			28.3	
Approach LOS		C			B			D			C	
Queue Length 50th (ft)	110	229		15	340	0	69	16		50	11	0
Queue Length 95th (ft)	#206	241		31	371	30	117	68		96	36	71
Internal Link Dist (ft)		347			406			277			368	
Turn Bay Length (ft)	300			330			80			120		100
Base Capacity (vph)	421	3411		438	3093	1021	253	199		239	114	456
Starvation Cap Reductn	0	549		0	0	0	0	0		0	0	0
Spillback Cap Reductn	0	0		0	0	0	0	0		0	0	0
Storage Cap Reductn	0	0		0	0	0	0	0		0	0	0
Reduced v/c Ratio	0.66	0.43		0.10	0.56	0.15	0.41	0.41		0.30	0.13	0.72

Intersection Summary

Cycle Length: 120
 Actuated Cycle Length: 120
 Offset: 36 (30%), Referenced to phase 2:EBT and 6:WBTL, Start of Green
 Natural Cycle: 60
 Control Type: Actuated-Coordinated

Timings

2: Allen Way & Founders Parkway (SH 86)

Background Traffic Volumes

Year 2023 - AM Peak Hour

Maximum v/c Ratio: 0.74

Intersection Signal Delay: 23.8

Intersection LOS: C

Intersection Capacity Utilization 64.4%

ICU Level of Service C

Analysis Period (min) 15

95th percentile volume exceeds capacity, queue may be longer.

Queue shown is maximum after two cycles.

Splits and Phases: 2: Allen Way & Founders Parkway (SH 86)

Ø2 (R)		Ø1		Ø3		Ø4	
83 s		11 s		14 s		12 s	
Ø5		Ø6 (R)		Ø7		Ø8	
15 s		79 s		13 s		13 s	

Timings

Background Traffic Volumes

3: I-25 NB Off-Ramp/I-25 NB On-Ramp & Founders Parkway (SH 86)

Year 2023 - AM Peak Hour

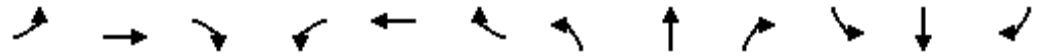

Lane Group	EBL	EBT	EBR	WBL	WBT	WBR	NBL	NBT	NBR	SBL	SBT	SBR
Lane Configurations		↑↑↑	↗		↑↑	↗	↖↖		↖↖			
Traffic Volume (vph)	0	1014	550	0	772	1327	225	0	224	0	0	0
Future Volume (vph)	0	1014	550	0	772	1327	225	0	224	0	0	0
Satd. Flow (prot)	0	4691	1362	0	3156	1441	3433	0	2787	0	0	0
Flt Permitted							0.950					
Satd. Flow (perm)	0	4691	1362	0	3156	1441	3433	0	2787	0	0	0
Satd. Flow (RTOR)		71	383		420	721			235			
Lane Group Flow (vph)	0	1317	383	0	1560	721	245	0	243	0	0	0
Turn Type		NA	Free		NA	Free	Prot		Prot			
Protected Phases		2			2		4		4			
Permitted Phases			Free			Free						
Detector Phase		2			2		4		4			
Switch Phase												
Minimum Initial (s)		20.0			20.0		5.0		5.0			
Minimum Split (s)		26.0			26.0		10.5		10.5			
Total Split (s)		89.0			89.0		31.0		31.0			
Total Split (%)		74.2%			74.2%		25.8%		25.8%			
Yellow Time (s)		4.0			4.0		3.5		3.5			
All-Red Time (s)		2.0			2.0		2.0		2.0			
Lost Time Adjust (s)		0.0			0.0		0.0		0.0			
Total Lost Time (s)		6.0			6.0		5.5		5.5			
Lead/Lag												
Lead-Lag Optimize?												
Recall Mode		C-Max			C-Max		None		None			
Act Effct Green (s)		94.6	120.0		94.6	120.0	13.9		13.9			
Actuated g/C Ratio		0.79	1.00		0.79	1.00	0.12		0.12			
v/c Ratio		0.35	0.28		0.61	0.50	0.62		0.46			
Control Delay		3.9	0.5		5.2	3.6	57.2		9.6			
Queue Delay		0.0	0.0		0.3	0.0	0.0		0.0			
Total Delay		3.9	0.5		5.4	3.6	57.2		9.6			
LOS		A	A		A	A	E		A			
Approach Delay		3.2			4.9			33.5				
Approach LOS		A			A			C				
Queue Length 50th (ft)		88	0		66	67	94		3			
Queue Length 95th (ft)		127	0		50	128	132		43			
Internal Link Dist (ft)		649			347			213			215	
Turn Bay Length (ft)			500						100			
Base Capacity (vph)		3713	1362		2577	1441	729		777			
Starvation Cap Reductn		0	0		393	0	0		0			
Spillback Cap Reductn		33	0		0	0	0		1			
Storage Cap Reductn		0	0		0	0	0		0			
Reduced v/c Ratio		0.36	0.28		0.71	0.50	0.34		0.31			

Intersection Summary

Cycle Length: 120
Actuated Cycle Length: 120
Offset: 35 (29%), Referenced to phase 2:EBWB, Start of Green
Natural Cycle: 45
Control Type: Actuated-Coordinated

Timings

Background Traffic Volumes

3: I-25 NB Off-Ramp/I-25 NB On-Ramp & Founders Parkway (SH 86)

Year 2023 - AM Peak Hour

Maximum v/c Ratio: 0.62

Intersection Signal Delay: 7.3

Intersection LOS: A

Intersection Capacity Utilization 50.3%

ICU Level of Service A























Analysis Period (min) 15

Splits and Phases: 3: I-25 NB Off-Ramp/I-25 NB On-Ramp & Founders Parkway (SH 86)

  Ø2 (R)	  Ø4
89 s	31 s

Timings
4: Allen Way & Allen Street

Background Traffic Volumes
 Year 2023 - AM Peak Hour

												
Lane Group	EBL	EBT	EBR	WBL	WBT	WBR	NBL	NBT	NBR	SBL	SBT	SBR
Lane Configurations												
Traffic Volume (vph)	7	11	92	55	17	52	119	257	37	21	225	4
Future Volume (vph)	7	11	92	55	17	52	119	257	37	21	225	4
Satd. Flow (prot)	1770	1613	0	1770	1863	1583	1770	3539	1583	0	3518	0
Flt Permitted	0.440			0.685			0.584				0.922	
Satd. Flow (perm)	820	1613	0	1276	1863	1583	1088	3539	1583	0	3257	0
Satd. Flow (RTOR)		100					218		218		3	
Lane Group Flow (vph)	8	112	0	60	18	57	129	279	40	0	272	0
Turn Type	pm+pt	NA		Perm	NA	Perm	Perm	NA	Perm	D.P+P	NA	
Protected Phases	3	8			4			6		5	2	
Permitted Phases	8			4		4	6		6	6		
Detector Phase	3	8		4	4	4	6	6	6	5	2	
Switch Phase												
Minimum Initial (s)	3.0	5.0		5.0	5.0	5.0	5.0	5.0	5.0	3.0	5.0	
Minimum Split (s)	8.0	10.0		10.0	10.0	10.0	10.0	10.0	10.0	8.0	10.0	
Total Split (s)	12.0	27.0		15.0	15.0	15.0	21.0	21.0	21.0	12.0	33.0	
Total Split (%)	20.0%	45.0%		25.0%	25.0%	25.0%	35.0%	35.0%	35.0%	20.0%	55.0%	
Yellow Time (s)	3.0	3.0		3.0	3.0	3.0	3.0	3.0	3.0	3.0	3.0	
All-Red Time (s)	2.0	2.0		2.0	2.0	2.0	2.0	2.0	2.0	2.0	2.0	
Lost Time Adjust (s)	0.0	0.0		0.0	0.0	0.0	0.0	0.0	0.0		0.0	
Total Lost Time (s)	5.0	5.0		5.0	5.0	5.0	5.0	5.0	5.0		5.0	
Lead/Lag	Lead			Lag	Lag	Lag	Lag	Lag	Lag	Lead		
Lead-Lag Optimize?	Yes			Yes	Yes	Yes	Yes	Yes	Yes	Yes		
Recall Mode	None	None		None	None	None	C-Min	C-Min	C-Min	None	C-Min	
Act Effct Green (s)	10.5	10.5		8.3	8.3	8.3	42.6	42.6	42.6		42.6	
Actuated g/C Ratio	0.18	0.18		0.14	0.14	0.14	0.71	0.71	0.71		0.71	
v/c Ratio	0.03	0.31		0.34	0.07	0.14	0.17	0.11	0.03		0.12	
Control Delay	16.4	7.5		28.0	21.6	0.7	4.1	2.1	0.1		5.2	
Queue Delay	0.0	0.0		0.0	0.0	0.0	0.0	0.0	0.0		0.0	
Total Delay	16.4	7.5		28.0	21.6	0.7	4.1	2.1	0.1		5.2	
LOS	B	A		C	C	A	A	A	A		A	
Approach Delay		8.1			15.6			2.5			5.2	
Approach LOS		A			B			A			A	
Queue Length 50th (ft)	3	4		20	6	0	4	4	0		13	
Queue Length 95th (ft)	9	29		48	20	0	m32	23	m0		48	
Internal Link Dist (ft)		422			420			368			300	
Turn Bay Length (ft)	60			95		65	70		95			
Base Capacity (vph)	259	658		218	319	452	772	2512	1187		2321	
Starvation Cap Reductn	0	0		0	0	0	0	0	0		0	
Spillback Cap Reductn	0	0		0	0	0	0	0	0		0	
Storage Cap Reductn	0	0		0	0	0	0	0	0		0	
Reduced v/c Ratio	0.03	0.17		0.28	0.06	0.13	0.17	0.11	0.03		0.12	

Intersection Summary

Cycle Length: 60
 Actuated Cycle Length: 60
 Offset: 31 (52%), Referenced to phase 2:SBT and 6:NBSB, Start of Green
 Natural Cycle: 40
 Control Type: Actuated-Coordinated

Timings

4: Allen Way & Allen Street

Background Traffic Volumes

Year 2023 - AM Peak Hour

Maximum v/c Ratio: 0.34

Intersection Signal Delay: 5.8

Intersection LOS: A

Intersection Capacity Utilization 36.3%

ICU Level of Service A

Analysis Period (min) 15

m Volume for 95th percentile queue is metered by upstream signal.

Splits and Phases: 4: Allen Way & Allen Street

↓ Ø2 (R)	↑	↗ Ø3	↖ Ø4
33 s		12 s	15 s
↘ Ø5	↓	↖ Ø8	
12 s	↑ Ø6 (R)	27 s	
	21 s		

HCM 6th TWSC
5: Allen Street & Alexander Place

Background Traffic Volumes
Year 2023 - AM Peak Hour

Intersection												
Int Delay, s/veh	5.2											
Movement	EBL	EBT	EBR	WBL	WBT	WBR	NBL	NBT	NBR	SBL	SBT	SBR
Lane Configurations		↔		↵	↶		↵	↶	↷	↵	↶	
Traffic Vol, veh/h	28	3	18	27	3	76	23	72	42	30	33	15
Future Vol, veh/h	28	3	18	27	3	76	23	72	42	30	33	15
Conflicting Peds, #/hr	0	0	0	0	0	0	0	0	0	0	0	0
Sign Control	Stop	Stop	Stop	Stop	Stop	Stop	Free	Free	Free	Free	Free	Free
RT Channelized	-	-	None	-	-	None	-	-	None	-	-	None
Storage Length	-	-	-	60	-	-	75	-	75	80	-	-
Veh in Median Storage, #	-	0	-	-	0	-	-	0	-	-	0	-
Grade, %	-	0	-	-	0	-	-	0	-	-	0	-
Peak Hour Factor	92	92	92	92	92	92	92	92	92	92	92	92
Heavy Vehicles, %	2	2	2	2	2	2	2	2	2	2	2	2
Mvmt Flow	30	3	20	29	3	83	25	78	46	33	36	16

Major/Minor	Minor2		Minor1		Major1		Major2					
Conflicting Flow All	304	284	44	250	246	78	52	0	0	124	0	0
Stage 1	110	110	-	128	128	-	-	-	-	-	-	-
Stage 2	194	174	-	122	118	-	-	-	-	-	-	-
Critical Hdwy	7.12	6.52	6.22	7.12	6.52	6.22	4.12	-	-	4.12	-	-
Critical Hdwy Stg 1	6.12	5.52	-	6.12	5.52	-	-	-	-	-	-	-
Critical Hdwy Stg 2	6.12	5.52	-	6.12	5.52	-	-	-	-	-	-	-
Follow-up Hdwy	3.518	4.018	3.318	3.518	4.018	3.318	2.218	-	-	2.218	-	-
Pot Cap-1 Maneuver	648	625	1026	703	656	983	1554	-	-	1463	-	-
Stage 1	895	804	-	876	790	-	-	-	-	-	-	-
Stage 2	808	755	-	882	798	-	-	-	-	-	-	-
Platoon blocked, %								-	-	-	-	-
Mov Cap-1 Maneuver	574	601	1026	666	630	983	1554	-	-	1463	-	-
Mov Cap-2 Maneuver	574	601	-	666	630	-	-	-	-	-	-	-
Stage 1	881	786	-	862	777	-	-	-	-	-	-	-
Stage 2	725	743	-	842	780	-	-	-	-	-	-	-

Approach	EB		WB		NB		SB	
HCM Control Delay, s	10.7		9.5		1.2		2.9	
HCM LOS	B		A					

Minor Lane/Major Mvmt	NBL	NBT	NBR	EBLn1	WBLn1	WBLn2	SBL	SBT	SBR
Capacity (veh/h)	1554	-	-	687	666	963	1463	-	-
HCM Lane V/C Ratio	0.016	-	-	0.078	0.044	0.089	0.022	-	-
HCM Control Delay (s)	7.4	-	-	10.7	10.7	9.1	7.5	-	-
HCM Lane LOS	A	-	-	B	B	A	A	-	-
HCM 95th %tile Q(veh)	0	-	-	0.3	0.1	0.3	0.1	-	-

HCM 6th AWSC
6: Allen Street & Front Street

Background Traffic Volumes
Year 2023 - AM Peak Hour

Intersection	
Intersection Delay, s/veh	8.3
Intersection LOS	A

Movement	EBL	EBR	NBL	NBT	SBT	SBR
Lane Configurations	↙	↗	↙	↗	↗	↗
Traffic Vol, veh/h	60	40	55	92	62	44
Future Vol, veh/h	60	40	55	92	62	44
Peak Hour Factor	0.92	0.92	0.92	0.92	0.92	0.92
Heavy Vehicles, %	2	2	2	2	2	2
Mvmt Flow	65	43	60	100	67	48
Number of Lanes	1	1	1	1	1	1

Approach	EB	NB	SB
Opposing Approach		SB	NB
Opposing Lanes	0	2	2
Conflicting Approach Left	SB	EB	
Conflicting Lanes Left	2	2	0
Conflicting Approach Right	NB		EB
Conflicting Lanes Right	2	0	2
HCM Control Delay	8.5	8.5	7.8
HCM LOS	A	A	A

Lane	NBLn1	NBLn2	EBLn1	EBLn2	SBLn1	SBLn2
Vol Left, %	100%	0%	100%	0%	0%	0%
Vol Thru, %	0%	100%	0%	0%	100%	0%
Vol Right, %	0%	0%	0%	100%	0%	100%
Sign Control	Stop	Stop	Stop	Stop	Stop	Stop
Traffic Vol by Lane	55	92	60	40	62	44
LT Vol	55	0	60	0	0	0
Through Vol	0	92	0	0	62	0
RT Vol	0	0	0	40	0	44
Lane Flow Rate	60	100	65	43	67	48
Geometry Grp	7	7	7	7	7	7
Degree of Util (X)	0.09	0.137	0.103	0.054	0.093	0.057
Departure Headway (Hd)	5.421	4.919	5.696	4.492	4.97	4.267
Convergence, Y/N	Yes	Yes	Yes	Yes	Yes	Yes
Cap	663	731	631	799	723	841
Service Time	3.136	2.635	3.415	2.211	2.686	1.983
HCM Lane V/C Ratio	0.09	0.137	0.103	0.054	0.093	0.057
HCM Control Delay	8.7	8.4	9.1	7.5	8.2	7.2
HCM Lane LOS	A	A	A	A	A	A
HCM 95th-tile Q	0.3	0.5	0.3	0.2	0.3	0.2

HCM 6th TWSC
7: Private Access/Brewer Court & Alexander Place

Background Traffic Volumes
Year 2023 - AM Peak Hour

Intersection												
Int Delay, s/veh	5											
Movement	EBL	EBT	EBR	WBL	WBT	WBR	NBL	NBT	NBR	SBL	SBT	SBR
Lane Configurations	↕			↕			↕			↕		
Traffic Vol, veh/h	38	10	29	0	12	0	12	2	0	0	2	27
Future Vol, veh/h	38	10	29	0	12	0	12	2	0	0	2	27
Conflicting Peds, #/hr	0	0	0	0	0	0	0	0	0	0	0	0
Sign Control	Free	Free	Free	Free	Free	Free	Stop	Stop	Stop	Stop	Stop	Stop
RT Channelized	-	-	None	-	-	None	-	-	None	-	-	None
Storage Length	-	-	-	-	-	-	-	-	-	-	-	-
Veh in Median Storage, #	-	0	-	-	0	-	-	0	-	-	0	-
Grade, %	-	0	-	-	0	-	-	0	-	-	0	-
Peak Hour Factor	92	92	92	92	92	92	92	92	92	92	92	92
Heavy Vehicles, %	2	2	2	2	2	2	2	2	2	2	2	2
Mvmt Flow	41	11	32	0	13	0	13	2	0	0	2	29





























Major/Minor	Major1			Major2			Minor1			Minor2		
Conflicting Flow All	13	0	0	43	0	0	138	122	27	123	138	13
Stage 1	-	-	-	-	-	-	109	109	-	13	13	-
Stage 2	-	-	-	-	-	-	29	13	-	110	125	-
Critical Hdwy	4.12	-	-	4.12	-	-	7.12	6.52	6.22	7.12	6.52	6.22
Critical Hdwy Stg 1	-	-	-	-	-	-	6.12	5.52	-	6.12	5.52	-
Critical Hdwy Stg 2	-	-	-	-	-	-	6.12	5.52	-	6.12	5.52	-
Follow-up Hdwy	2.218	-	-	2.218	-	-	3.518	4.018	3.318	3.518	4.018	3.318
Pot Cap-1 Maneuver	1606	-	-	1566	-	-	833	768	1048	852	753	1067
Stage 1	-	-	-	-	-	-	896	805	-	1007	885	-
Stage 2	-	-	-	-	-	-	988	885	-	895	792	-
Platoon blocked, %	-	-	-	-	-	-	-	-	-	-	-	-
Mov Cap-1 Maneuver	1606	-	-	1566	-	-	792	748	1048	833	733	1067
Mov Cap-2 Maneuver	-	-	-	-	-	-	792	748	-	833	733	-
Stage 1	-	-	-	-	-	-	873	784	-	981	885	-
Stage 2	-	-	-	-	-	-	958	885	-	869	771	-

Approach	EB			WB			NB			SB		
HCM Control Delay, s	3.6			0			9.7			8.6		
HCM LOS							A			A		

Minor Lane/Major Mvmt	NBLn1	EBL	EBT	EBR	WBL	WBT	WBR	SBLn1
Capacity (veh/h)	785	1606	-	-	1566	-	-	1034
HCM Lane V/C Ratio	0.019	0.026	-	-	-	-	-	0.03
HCM Control Delay (s)	9.7	7.3	0	-	0	-	-	8.6
HCM Lane LOS	A	A	A	-	A	-	-	A
HCM 95th %tile Q(veh)	0.1	0.1	-	-	0	-	-	0.1

Timings
1: Front Street & Founders Parkway (SH 86)

Background Traffic Volumes
 Year 2023 - PM Peak Hour

												
Lane Group	EBL	EBT	EBR	WBL	WBT	WBR	NBL	NBT	NBR	SBL	SBT	SBR
Lane Configurations	 		 		 			  			  	
Traffic Volume (vph)	321	116	177	31	77	90	103	1386	13	165	1745	354
Future Volume (vph)	321	116	177	31	77	90	103	1386	13	165	1745	354
Satd. Flow (prot)	3433	1863	1583	1770	3253	0	1770	5080	0	1770	4958	0
Flt Permitted	0.448			0.676			0.056			0.117		
Satd. Flow (perm)	1619	1863	1583	1259	3253	0	104	5080	0	218	4958	0
Satd. Flow (RTOR)			164		98			2			71	
Lane Group Flow (vph)	349	126	192	34	182	0	112	1521	0	179	2282	0
Turn Type	pm+pt	NA	Perm	pm+pt	NA		pm+pt	NA		pm+pt	NA	
Protected Phases	7	4		3	8		1	6		5	2	
Permitted Phases	4		4	8			6			2		
Detector Phase	7	4	4	3	8		1	6		5	2	
Switch Phase												
Minimum Initial (s)	3.0	5.0	5.0	3.0	5.0		3.0	20.0		3.0	20.0	
Minimum Split (s)	10.0	11.0	11.0	10.0	11.0		10.0	26.0		10.0	26.0	
Total Split (s)	13.0	13.0	13.0	13.0	13.0		11.0	74.0		20.0	83.0	
Total Split (%)	10.8%	10.8%	10.8%	10.8%	10.8%		9.2%	61.7%		16.7%	69.2%	
Yellow Time (s)	3.0	4.0	4.0	3.0	4.0		3.0	4.0		3.0	4.0	
All-Red Time (s)	2.0	2.0	2.0	2.0	2.0		2.0	2.0		2.0	2.0	
Lost Time Adjust (s)	0.0	0.0	0.0	0.0	0.0		0.0	0.0		0.0	0.0	
Total Lost Time (s)	5.0	6.0	6.0	5.0	6.0		5.0	6.0		5.0	6.0	
Lead/Lag	Lead	Lag	Lag	Lead	Lag		Lead	Lag		Lead	Lag	
Lead-Lag Optimize?	Yes	Yes	Yes	Yes	Yes		Yes	Yes		Yes	Yes	
Recall Mode	None	None	None	None	None		None	C-Max		None	C-Max	
Act Effct Green (s)	17.8	12.0	12.0	14.8	6.7		80.6	73.4		87.3	77.2	
Actuated g/C Ratio	0.15	0.10	0.10	0.12	0.06		0.67	0.61		0.73	0.64	
v/c Ratio	0.97	0.68	0.63	0.18	0.66		0.73	0.49		0.63	0.71	
Control Delay	87.9	72.5	22.5	44.5	38.3		47.7	13.9		17.4	15.1	
Queue Delay	0.0	0.0	0.0	0.0	0.0		0.0	0.0		0.0	0.0	
Total Delay	87.9	72.5	22.5	44.5	38.3		47.7	13.9		17.4	15.1	
LOS	F	E	C	D	D		D	B		B	B	
Approach Delay		66.2			39.3			16.2			15.3	
Approach LOS		E			D			B			B	
Queue Length 50th (ft)	~130	~108	21	22	33		32	219		34	384	
Queue Length 95th (ft)	#201	#241	#133	53	72		#131	292		87	436	
Internal Link Dist (ft)		695			413			423			624	
Turn Bay Length (ft)	285		285	195			175			455		
Base Capacity (vph)	361	186	305	198	282		154	3109		356	3213	
Starvation Cap Reductn	0	0	0	0	0		0	0		0	0	
Spillback Cap Reductn	0	0	0	0	0		0	0		0	0	
Storage Cap Reductn	0	0	0	0	0		0	0		0	0	
Reduced v/c Ratio	0.97	0.68	0.63	0.17	0.65		0.73	0.49		0.50	0.71	

Intersection Summary

Cycle Length: 120
 Actuated Cycle Length: 120
 Offset: 112 (93%), Referenced to phase 2:SBTL and 6:NBTL, Start of Green
 Natural Cycle: 75
 Control Type: Actuated-Coordinated

Timings

1: Front Street & Founders Parkway (SH 86)

Background Traffic Volumes

Year 2023 - PM Peak Hour

Maximum v/c Ratio: 0.97

Intersection Signal Delay: 23.5

Intersection LOS: C

Intersection Capacity Utilization 79.8%

ICU Level of Service D

Analysis Period (min) 15









~ Volume exceeds capacity, queue is theoretically infinite.

Queue shown is maximum after two cycles.

95th percentile volume exceeds capacity, queue may be longer.

Queue shown is maximum after two cycles.

Splits and Phases: 1: Front Street & Founders Parkway (SH 86)

 Ø1	 Ø2 (R)	 Ø3	 Ø4
11 s	83 s	13 s	13 s
 Ø5	 Ø6 (R)	 Ø7	 Ø8
20 s	74 s	13 s	13 s

Timings
2: Allen Way & Founders Parkway (SH 86)

Background Traffic Volumes
 Year 2023 - PM Peak Hour

Lane Group	EBL	EBT	EBR	WBL	WBT	WBR	NBL	NBT	NBR	SBL	SBT	SBR
Lane Configurations												
Traffic Volume (vph)	378	2176	248	48	1620	130	163	28	51	68	58	429
Future Volume (vph)	378	2176	248	48	1620	130	163	28	51	68	58	429
Satd. Flow (prot)	3433	5009	0	1770	5085	1583	1770	1682	0	1770	1863	2787
Flt Permitted	0.950			0.065			0.514			0.702		
Satd. Flow (perm)	3433	5009	0	121	5085	1583	957	1682	0	1308	1863	2787
Satd. Flow (RTOR)		33				141		55				377
Lane Group Flow (vph)	411	2635	0	52	1761	141	177	85	0	74	63	466
Turn Type	Prot	NA		pm+pt	NA	Perm	pm+pt	NA		pm+pt	NA	Perm
Protected Phases	5	2		1	6		7	4		3	8	
Permitted Phases				6		6	4			8		8
Detector Phase	5	2		1	6	6	7	4		3	8	8
Switch Phase												
Minimum Initial (s)	5.0	20.0		5.0	20.0	20.0	5.0	5.0		5.0	5.0	5.0
Minimum Split (s)	10.0	26.0		10.0	26.0	26.0	10.0	11.0		11.0	11.0	11.0
Total Split (s)	20.0	83.0		11.0	74.0	74.0	13.0	13.0		13.0	13.0	13.0
Total Split (%)	16.7%	69.2%		9.2%	61.7%	61.7%	10.8%	10.8%		10.8%	10.8%	10.8%
Yellow Time (s)	3.0	4.0		3.0	4.0	4.0	3.0	4.0		3.0	4.0	4.0
All-Red Time (s)	2.0	2.0		2.0	2.0	2.0	2.0	2.0		2.0	2.0	2.0
Lost Time Adjust (s)	0.0	0.0		0.0	0.0	0.0	0.0	0.0		0.0	0.0	0.0
Total Lost Time (s)	5.0	6.0		5.0	6.0	6.0	5.0	6.0		5.0	6.0	6.0
Lead/Lag	Lead	Lead		Lag	Lag	Lag	Lead	Lag		Lead	Lag	Lag
Lead-Lag Optimize?	Yes	Yes		Yes	Yes	Yes	Yes	Yes		Yes	Yes	Yes
Recall Mode	None	C-Min		None	C-Min	C-Min	None	None		None	None	None
Act Effct Green (s)	15.4	77.8		68.1	66.0	66.0	19.0	11.0		15.8	7.0	7.0
Actuated g/C Ratio	0.13	0.65		0.57	0.55	0.55	0.16	0.09		0.13	0.06	0.06
v/c Ratio	0.93	0.81		0.35	0.63	0.15	0.82	0.42		0.37	0.58	0.90
Control Delay	79.8	12.2		33.9	19.6	2.3	75.3	30.4		50.3	79.0	37.2
Queue Delay	0.0	1.2		0.0	0.0	0.0	0.0	0.0		0.0	0.0	0.3
Total Delay	79.8	13.4		33.9	19.7	2.3	75.3	30.4		50.3	79.0	37.5
LOS	E	B		C	B	A	E	C		D	E	D
Approach Delay		22.3			18.8			60.7			43.4	
Approach LOS		C			B			E			D	
Queue Length 50th (ft)	175	187		17	319	0	126	23		46	50	43
Queue Length 95th (ft)	m#262	307		35	362	28	#232	#77		m95	m#100	#140
Internal Link Dist (ft)		347			406			277			368	
Turn Bay Length (ft)	300			330			80			120		100
Base Capacity (vph)	442	3276		151	2881	958	216	204		207	108	517
Starvation Cap Reductn	0	389		0	0	0	0	0		0	0	0
Spillback Cap Reductn	0	0		0	40	0	0	0		0	0	2
Storage Cap Reductn	0	0		0	0	0	0	0		0	0	0
Reduced v/c Ratio	0.93	0.91		0.34	0.62	0.15	0.82	0.42		0.36	0.58	0.90

Intersection Summary
 Cycle Length: 120
 Actuated Cycle Length: 120
 Offset: 107 (89%), Referenced to phase 2:EBT and 6:WBTL, Start of Green
 Natural Cycle: 90
 Control Type: Actuated-Coordinated

Timings

2: Allen Way & Founders Parkway (SH 86)

Background Traffic Volumes

Year 2023 - PM Peak Hour

Maximum v/c Ratio: 0.93

Intersection Signal Delay: 25.0

Intersection LOS: C

Intersection Capacity Utilization 81.6%

ICU Level of Service D

Analysis Period (min) 15

95th percentile volume exceeds capacity, queue may be longer.

Queue shown is maximum after two cycles.

m Volume for 95th percentile queue is metered by upstream signal.

Splits and Phases: 2: Allen Way & Founders Parkway (SH 86)

 83 s		 11 s		 13 s		 13 s	
 20 s		 74 s		 13 s		 13 s	

Timings

Background Traffic Volumes

3: I-25 NB Off-Ramp/I-25 NB On-Ramp & Founders Parkway (SH 86)

Year 2023 - PM Peak Hour



Lane Group	EBL	EBT	EBR	WBL	WBT	WBR	NBL	NBT	NBR	SBL	SBT	SBR
Lane Configurations		↑↑↑	↗		↑↑	↗	↘↘		↘↘			
Traffic Volume (vph)	0	2444	584	0	1224	999	415	0	366	0	0	0
Future Volume (vph)	0	2444	584	0	1224	999	415	0	366	0	0	0
Satd. Flow (prot)	0	4787	1362	0	3285	1441	3433	0	2787	0	0	0
Flt Permitted							0.950					
Satd. Flow (perm)	0	4787	1362	0	3285	1441	3433	0	2787	0	0	0
Satd. Flow (RTOR)		6	363		53	424			27			
Lane Group Flow (vph)	0	2721	571	0	1678	738	451	0	398	0	0	0
Turn Type		NA	Free		NA	Free	Prot		Prot			
Protected Phases		2			2		4		4			
Permitted Phases			Free			Free						
Detector Phase		2			2		4		4			
Switch Phase												
Minimum Initial (s)		20.0			20.0		5.0		5.0			
Minimum Split (s)		26.0			26.0		10.5		10.5			
Total Split (s)		85.0			85.0		35.0		35.0			
Total Split (%)		70.8%			70.8%		29.2%		29.2%			
Yellow Time (s)		4.0			4.0		3.5		3.5			
All-Red Time (s)		2.0			2.0		2.0		2.0			
Lost Time Adjust (s)		0.0			0.0		0.0		0.0			
Total Lost Time (s)		6.0			6.0		5.5		5.5			
Lead/Lag												
Lead-Lag Optimize?												
Recall Mode		C-Max			C-Max		None		None			
Act Effct Green (s)		86.6	120.0		86.6	120.0	21.9		21.9			
Actuated g/C Ratio		0.72	1.00		0.72	1.00	0.18		0.18			
v/c Ratio		0.79	0.42		0.70	0.51	0.72		0.75			
Control Delay		13.7	1.0		6.9	2.6	52.6		52.0			
Queue Delay		0.0	0.0		0.1	0.0	0.0		0.2			
Total Delay		13.7	1.0		7.0	2.6	52.6		52.2			
LOS		B	A		A	A	D		D			
Approach Delay		11.5			5.7			52.4				
Approach LOS		B			A			D				
Queue Length 50th (ft)		469	0		116	0	170		156			
Queue Length 95th (ft)		646	0		144	m437	213		205			
Internal Link Dist (ft)		649			347			213			215	
Turn Bay Length (ft)			500						100			
Base Capacity (vph)		3455	1362		2385	1441	843		705			
Starvation Cap Reductn		0	0		51	0	0		0			
Spillback Cap Reductn		0	0		0	0	0		36			
Storage Cap Reductn		0	0		0	0	0		0			
Reduced v/c Ratio		0.79	0.42		0.72	0.51	0.53		0.59			

Intersection Summary

Cycle Length: 120
 Actuated Cycle Length: 120
 Offset: 106 (88%), Referenced to phase 2:EBWB, Start of Green
 Natural Cycle: 60
 Control Type: Actuated-Coordinated

Timings

Background Traffic Volumes

3: I-25 NB Off-Ramp/I-25 NB On-Ramp & Founders Parkway (SH 86)

Year 2023 - PM Peak Hour

Maximum v/c Ratio: 0.79

Intersection Signal Delay: 14.6

Intersection LOS: B

Intersection Capacity Utilization 73.9%

ICU Level of Service D

Analysis Period (min) 15























m Volume for 95th percentile queue is metered by upstream signal.

Splits and Phases: 3: I-25 NB Off-Ramp/I-25 NB On-Ramp & Founders Parkway (SH 86)

  Ø2 (R)	  Ø4
85 s	35 s

Timings
4: Allen Way & Allen Street

Background Traffic Volumes
Year 2023 - PM Peak Hour

												
Lane Group	EBL	EBT	EBR	WBL	WBT	WBR	NBL	NBT	NBR	SBL	SBT	SBR
Lane Configurations												
Traffic Volume (vph)	2	61	88	154	24	44	150	324	82	15	355	10
Future Volume (vph)	2	61	88	154	24	44	150	324	82	15	355	10
Satd. Flow (prot)	1770	1697	0	1770	1863	1583	1770	3539	1583	0	3518	0
Flt Permitted	0.534			0.654			0.510				0.938	
Satd. Flow (perm)	995	1697	0	1218	1863	1583	950	3539	1583	0	3307	0
Satd. Flow (RTOR)		96				218			218		6	
Lane Group Flow (vph)	2	162	0	167	26	48	163	352	89	0	413	0
Turn Type	pm+pt	NA		Perm	NA	Perm	Perm	NA	Perm	D.P+P	NA	
Protected Phases	3	8			4			6		5	2	
Permitted Phases	8			4		4	6		6	6		
Detector Phase	3	8		4	4	4	6	6	6	5	2	
Switch Phase												
Minimum Initial (s)	3.0	5.0		5.0	5.0	5.0	5.0	5.0	5.0	3.0	5.0	
Minimum Split (s)	8.0	10.0		10.0	10.0	10.0	10.0	10.0	10.0	8.0	10.0	
Total Split (s)	12.0	27.0		15.0	15.0	15.0	21.0	21.0	21.0	12.0	33.0	
Total Split (%)	20.0%	45.0%		25.0%	25.0%	25.0%	35.0%	35.0%	35.0%	20.0%	55.0%	
Yellow Time (s)	3.0	3.0		3.0	3.0	3.0	3.0	3.0	3.0	3.0	3.0	
All-Red Time (s)	2.0	2.0		2.0	2.0	2.0	2.0	2.0	2.0	2.0	2.0	
Lost Time Adjust (s)	0.0	0.0		0.0	0.0	0.0	0.0	0.0	0.0		0.0	
Total Lost Time (s)	5.0	5.0		5.0	5.0	5.0	5.0	5.0	5.0		5.0	
Lead/Lag	Lead			Lag	Lag	Lag	Lag	Lag	Lag	Lead		
Lead-Lag Optimize?	Yes			Yes	Yes	Yes	Yes	Yes	Yes	Yes		
Recall Mode	None	None		None	None	None	C-Min	C-Min	C-Min	None	C-Min	
Act Effct Green (s)	15.0	15.0		12.9	12.9	12.9	35.0	35.0	35.0		35.0	
Actuated g/C Ratio	0.25	0.25		0.22	0.22	0.22	0.58	0.58	0.58		0.58	
v/c Ratio	0.01	0.33		0.64	0.07	0.09	0.29	0.17	0.09		0.21	
Control Delay	13.5	9.2		35.8	19.0	0.4	17.0	11.8	4.2		7.2	
Queue Delay	0.0	0.0		0.0	0.0	0.0	0.0	0.0	0.0		0.0	
Total Delay	13.5	9.2		35.8	19.0	0.4	17.0	11.8	4.2		7.2	
LOS	B	A		D	B	A	B	B	A		A	
Approach Delay		9.3			26.9			12.1			7.2	
Approach LOS		A			C			B			A	
Queue Length 50th (ft)	1	19		53	7	0	79	87	12		32	
Queue Length 95th (ft)	4	49		#144	25	0	m83	m76	m5		69	
Internal Link Dist (ft)		422			420			368			300	
Turn Bay Length (ft)	60			95		65	70		95			
Base Capacity (vph)	339	683		265	405	514	553	2062	1013		1929	
Starvation Cap Reductn	0	0		0	0	0	0	0	0		0	
Spillback Cap Reductn	0	0		0	0	0	0	0	0		0	
Storage Cap Reductn	0	0		0	0	0	0	0	0		0	
Reduced v/c Ratio	0.01	0.24		0.63	0.06	0.09	0.29	0.17	0.09		0.21	

Intersection Summary

Cycle Length: 60
 Actuated Cycle Length: 60
 Offset: 31 (52%), Referenced to phase 2:SBT and 6:NBSB, Start of Green
 Natural Cycle: 60
 Control Type: Actuated-Coordinated

Timings

4: Allen Way & Allen Street

Background Traffic Volumes

Year 2023 - PM Peak Hour

Maximum v/c Ratio: 0.64

Intersection Signal Delay: 12.8

Intersection LOS: B

Intersection Capacity Utilization 53.3%

ICU Level of Service A

Analysis Period (min) 15

95th percentile volume exceeds capacity, queue may be longer.

Queue shown is maximum after two cycles.

m Volume for 95th percentile queue is metered by upstream signal.

Splits and Phases: 4: Allen Way & Allen Street

↓ Ø2 (R)	↓	↗ Ø3	← Ø4
33 s		12 s	15 s
↘ Ø5	↓	↖ Ø6 (R)	↗ Ø8
12 s	21 s	27 s	

HCM 6th TWSC
5: Allen Street & Alexander Place

Background Traffic Volumes
Year 2023 - PM Peak Hour

Intersection												
Int Delay, s/veh	6.6											
Movement	EBL	EBT	EBR	WBL	WBT	WBR	NBL	NBT	NBR	SBL	SBT	SBR
Lane Configurations		↕↔		↕	↔		↕	↑	↕	↕	↔	
Traffic Vol, veh/h	59	12	53	89	8	60	58	106	94	40	101	17
Future Vol, veh/h	59	12	53	89	8	60	58	106	94	40	101	17
Conflicting Peds, #/hr	0	0	0	0	0	0	0	0	0	0	0	0
Sign Control	Stop	Stop	Stop	Stop	Stop	Stop	Free	Free	Free	Free	Free	Free
RT Channelized	-	-	None	-	-	None	-	-	None	-	-	None
Storage Length	-	-	-	60	-	-	75	-	75	80	-	-
Veh in Median Storage, #	-	0	-	-	0	-	-	0	-	-	0	-
Grade, %	-	0	-	-	0	-	-	0	-	-	0	-
Peak Hour Factor	92	92	92	92	92	92	92	92	92	92	92	92
Heavy Vehicles, %	2	2	2	2	2	2	2	2	2	2	2	2
Mvmt Flow	64	13	58	97	9	65	63	115	102	43	110	18

Major/Minor	Minor2		Minor1		Major1		Major2					
Conflicting Flow All	534	548	119	482	455	115	128	0	0	217	0	0
Stage 1	205	205	-	241	241	-	-	-	-	-	-	-
Stage 2	329	343	-	241	214	-	-	-	-	-	-	-
Critical Hdwy	7.12	6.52	6.22	7.12	6.52	6.22	4.12	-	-	4.12	-	-
Critical Hdwy Stg 1	6.12	5.52	-	6.12	5.52	-	-	-	-	-	-	-
Critical Hdwy Stg 2	6.12	5.52	-	6.12	5.52	-	-	-	-	-	-	-
Follow-up Hdwy	3.518	4.018	3.318	3.518	4.018	3.318	2.218	-	-	2.218	-	-
Pot Cap-1 Maneuver	457	444	933	495	501	937	1458	-	-	1353	-	-
Stage 1	797	732	-	762	706	-	-	-	-	-	-	-
Stage 2	684	637	-	762	725	-	-	-	-	-	-	-
Platoon blocked, %								-	-	-	-	-
Mov Cap-1 Maneuver	396	411	933	428	464	937	1458	-	-	1353	-	-
Mov Cap-2 Maneuver	396	411	-	428	464	-	-	-	-	-	-	-
Stage 1	763	709	-	729	676	-	-	-	-	-	-	-
Stage 2	601	610	-	679	702	-	-	-	-	-	-	-

Approach	EB		WB		NB		SB	
HCM Control Delay, s	14.1		13.2		1.7		2	
HCM LOS	B		B					

Minor Lane/Major Mvmt	NBL	NBT	NBR	EBLn1	WBLn1	WBLn2	SBL	SBT	SBR
Capacity (veh/h)	1458	-	-	528	428	837	1353	-	-
HCM Lane V/C Ratio	0.043	-	-	0.255	0.226	0.088	0.032	-	-
HCM Control Delay (s)	7.6	-	-	14.1	15.9	9.7	7.7	-	-
HCM Lane LOS	A	-	-	B	C	A	A	-	-
HCM 95th %tile Q(veh)	0.1	-	-	1	0.9	0.3	0.1	-	-

HCM 6th AWSC
6: Allen Street & Front Street

Background Traffic Volumes
Year 2023 - PM Peak Hour

Intersection	
Intersection Delay, s/veh	10.6
Intersection LOS	B

Movement	EBL	EBR	NBL	NBT	SBT	SBR
Lane Configurations	↙	↗	↙	↗	↗	↗
Traffic Vol, veh/h	170	130	81	151	150	114
Future Vol, veh/h	170	130	81	151	150	114
Peak Hour Factor	0.92	0.92	0.92	0.92	0.92	0.92
Heavy Vehicles, %	2	2	2	2	2	2
Mvmt Flow	185	141	88	164	163	124
Number of Lanes	1	1	1	1	1	1

Approach	EB	NB	SB
Opposing Approach		SB	NB
Opposing Lanes	0	2	2
Conflicting Approach Left	SB	EB	
Conflicting Lanes Left	2	2	0
Conflicting Approach Right	NB		EB
Conflicting Lanes Right	2	0	2
HCM Control Delay	11.1	10.6	10
HCM LOS	B	B	A

Lane	NBLn1	NBLn2	EBLn1	EBLn2	SBLn1	SBLn2
Vol Left, %	100%	0%	100%	0%	0%	0%
Vol Thru, %	0%	100%	0%	0%	100%	0%
Vol Right, %	0%	0%	0%	100%	0%	100%
Sign Control	Stop	Stop	Stop	Stop	Stop	Stop
Traffic Vol by Lane	81	151	170	130	150	114
LT Vol	81	0	170	0	0	0
Through Vol	0	151	0	0	150	0
RT Vol	0	0	0	130	0	114
Lane Flow Rate	88	164	185	141	163	124
Geometry Grp	7	7	7	7	7	7
Degree of Util (X)	0.156	0.267	0.331	0.206	0.265	0.177
Departure Headway (Hd)	6.366	5.86	6.458	5.249	5.845	5.136
Convergence, Y/N	Yes	Yes	Yes	Yes	Yes	Yes
Cap	564	614	558	685	616	700
Service Time	4.09	3.584	4.183	2.973	3.568	2.859
HCM Lane V/C Ratio	0.156	0.267	0.332	0.206	0.265	0.177
HCM Control Delay	10.3	10.7	12.4	9.3	10.7	9
HCM Lane LOS	B	B	B	A	B	A
HCM 95th-tile Q	0.5	1.1	1.4	0.8	1.1	0.6

HCM 6th TWSC
7: Private Access/Brewer Court & Alexander Place

Background Traffic Volumes
Year 2023 - PM Peak Hour

Intersection												
Int Delay, s/veh	7.5											
Movement	EBL	EBT	EBR	WBL	WBT	WBR	NBL	NBT	NBR	SBL	SBT	SBR
Lane Configurations		↕			↕			↕			↕	
Traffic Vol, veh/h	113	17	7	0	17	0	20	2	0	0	2	128
Future Vol, veh/h	113	17	7	0	17	0	20	2	0	0	2	128
Conflicting Peds, #/hr	0	0	0	0	0	0	0	0	0	0	0	0
Sign Control	Free	Free	Free	Free	Free	Free	Stop	Stop	Stop	Stop	Stop	Stop
RT Channelized	-	-	None	-	-	None	-	-	None	-	-	None
Storage Length	-	-	-	-	-	-	-	-	-	-	-	-
Veh in Median Storage, #	-	0	-	-	0	-	-	0	-	-	0	-
Grade, %	-	0	-	-	0	-	-	0	-	-	0	-
Peak Hour Factor	92	92	92	92	92	92	92	92	92	92	92	92
Heavy Vehicles, %	2	2	2	2	2	2	2	2	2	2	2	2
Mvmt Flow	123	18	8	0	18	0	22	2	0	0	2	139





























Major/Minor	Major1			Major2			Minor1			Minor2		
Conflicting Flow All	18	0	0	26	0	0	357	286	22	287	290	18
Stage 1	-	-	-	-	-	-	268	268	-	18	18	-
Stage 2	-	-	-	-	-	-	89	18	-	269	272	-
Critical Hdwy	4.12	-	-	4.12	-	-	7.12	6.52	6.22	7.12	6.52	6.22
Critical Hdwy Stg 1	-	-	-	-	-	-	6.12	5.52	-	6.12	5.52	-
Critical Hdwy Stg 2	-	-	-	-	-	-	6.12	5.52	-	6.12	5.52	-
Follow-up Hdwy	2.218	-	-	2.218	-	-	3.518	4.018	3.318	3.518	4.018	3.318
Pot Cap-1 Maneuver	1599	-	-	1588	-	-	598	623	1055	665	620	1061
Stage 1	-	-	-	-	-	-	738	687	-	1001	880	-
Stage 2	-	-	-	-	-	-	918	880	-	737	685	-
Platoon blocked, %	-	-	-	-	-	-	-	-	-	-	-	-
Mov Cap-1 Maneuver	1599	-	-	1588	-	-	487	574	1055	624	572	1061
Mov Cap-2 Maneuver	-	-	-	-	-	-	487	574	-	624	572	-
Stage 1	-	-	-	-	-	-	680	633	-	923	880	-
Stage 2	-	-	-	-	-	-	796	880	-	677	632	-

Approach	EB	WB	NB	SB
HCM Control Delay, s	6.1	0	12.7	9
HCM LOS			B	A

Minor Lane/Major Mvmt	NBLn1	EBL	EBT	EBR	WBL	WBT	WBR	SBLn1
Capacity (veh/h)	494	1599	-	-	1588	-	-	1047
HCM Lane V/C Ratio	0.048	0.077	-	-	-	-	-	0.135
HCM Control Delay (s)	12.7	7.4	0	-	0	-	-	9
HCM Lane LOS	B	A	A	-	A	-	-	A
HCM 95th %tile Q(veh)	0.2	0.2	-	-	0	-	-	0.5

Timings
1: Front Street & Founders Parkway (SH 86)

Background Traffic Volumes
 Year 2023 - Saturday Peak Hour

												
Lane Group	EBL	EBT	EBR	WBL	WBT	WBR	NBL	NBT	NBR	SBL	SBT	SBR
Lane Configurations	 		 		 			  			  	
Traffic Volume (vph)	348	108	145	46	118	93	114	1554	39	160	1419	394
Future Volume (vph)	348	108	145	46	118	93	114	1554	39	160	1419	394
Satd. Flow (prot)	3433	1863	1583	1770	3306	0	1770	5065	0	1770	4917	0
Flt Permitted	0.485			0.682			0.083			0.080		
Satd. Flow (perm)	1753	1863	1583	1270	3306	0	155	5065	0	149	4917	0
Satd. Flow (RTOR)			196		101			5			98	
Lane Group Flow (vph)	378	117	158	50	229	0	124	1731	0	174	1970	0
Turn Type	pm+pt	NA	Perm	pm+pt	NA		pm+pt	NA		pm+pt	NA	
Protected Phases	7	4		3	8		1	6		5	2	
Permitted Phases	4		4	8			6			2		
Detector Phase	7	4	4	3	8		1	6		5	2	
Switch Phase												
Minimum Initial (s)	3.0	5.0	5.0	3.0	5.0		3.0	20.0		3.0	20.0	
Minimum Split (s)	10.0	11.0	11.0	10.0	11.0		10.0	26.0		10.0	26.0	
Total Split (s)	14.0	13.0	13.0	20.0	19.0		12.0	52.0		15.0	55.0	
Total Split (%)	14.0%	13.0%	13.0%	20.0%	19.0%		12.0%	52.0%		15.0%	55.0%	
Yellow Time (s)	3.0	4.0	4.0	3.0	4.0		3.0	4.0		3.0	4.0	
All-Red Time (s)	2.0	2.0	2.0	2.0	2.0		2.0	2.0		2.0	2.0	
Lost Time Adjust (s)	0.0	0.0	0.0	0.0	0.0		0.0	0.0		0.0	0.0	
Total Lost Time (s)	5.0	6.0	6.0	5.0	6.0		5.0	6.0		5.0	6.0	
Lead/Lag	Lead	Lag	Lag	Lead	Lag		Lead	Lag		Lead	Lag	
Lead-Lag Optimize?	Yes	Yes	Yes	Yes	Yes		Yes	Yes		Yes	Yes	
Recall Mode	None	None	None	None	None		None	C-Max		None	C-Max	
Act Effct Green (s)	22.2	14.0	14.0	19.2	10.5		57.4	49.2		61.6	51.3	
Actuated g/C Ratio	0.22	0.14	0.14	0.19	0.10		0.57	0.49		0.62	0.51	
v/c Ratio	0.70	0.45	0.41	0.18	0.52		0.60	0.69		0.72	0.77	
Control Delay	39.3	46.6	6.2	29.1	27.3		28.1	22.1		35.0	21.5	
Queue Delay	0.0	0.0	0.0	0.0	0.0		0.0	0.0		0.0	0.0	
Total Delay	39.3	46.6	6.2	29.1	27.3		28.1	22.1		35.0	21.5	
LOS	D	D	A	C	C		C	C		D	C	
Approach Delay		32.6			27.6			22.5			22.6	
Approach LOS		C			C			C			C	
Queue Length 50th (ft)	111	70	0	24	40		28	318		54	354	
Queue Length 95th (ft)	142	129	34	53	76		#100	379		#147	420	
Internal Link Dist (ft)		695			413			423			624	
Turn Bay Length (ft)	285		285	195			175			455		
Base Capacity (vph)	540	260	389	399	517		207	2492		258	2569	
Starvation Cap Reductn	0	0	0	0	0		0	0		0	0	
Spillback Cap Reductn	0	0	0	0	0		0	0		0	0	
Storage Cap Reductn	0	0	0	0	0		0	0		0	0	
Reduced v/c Ratio	0.70	0.45	0.41	0.13	0.44		0.60	0.69		0.67	0.77	

Intersection Summary

Cycle Length: 100
 Actuated Cycle Length: 100
 Offset: 62 (62%), Referenced to phase 2:SBTL and 6:NBTL, Start of Green
 Natural Cycle: 60
 Control Type: Actuated-Coordinated

Timings

1: Front Street & Founders Parkway (SH 86)

Background Traffic Volumes

Year 2023 - Saturday Peak Hour

Maximum v/c Ratio: 0.77

Intersection Signal Delay: 24.1

Intersection LOS: C

Intersection Capacity Utilization 77.0%









ICU Level of Service D

Analysis Period (min) 15

95th percentile volume exceeds capacity, queue may be longer.































Queue shown is maximum after two cycles.

Splits and Phases: 1: Front Street & Founders Parkway (SH 86)

 Ø1	 Ø2 (R)	 Ø3	 Ø4
12 s	55 s	20 s	13 s
 Ø5	 Ø6 (R)	 Ø7	 Ø8
15 s	52 s	14 s	19 s

Timings
2: Allen Way & Founders Parkway (SH 86)

Background Traffic Volumes
 Year 2023 - Saturday Peak Hour

												
Lane Group	EBL	EBT	EBR	WBL	WBT	WBR	NBL	NBT	NBR	SBL	SBT	SBR
Lane Configurations	 	  			  			 			 	  
Traffic Volume (vph)	473	1744	226	45	1738	202	189	37	90	140	39	516
Future Volume (vph)	473	1744	226	45	1738	202	189	37	90	140	39	516
Satd. Flow (prot)	3433	4999	0	1770	5085	1583	1770	1663	0	1770	1863	2787
Flt Permitted	0.950			0.100			0.635			0.603		
Satd. Flow (perm)	3433	4999	0	186	5085	1583	1183	1663	0	1123	1863	2787
Satd. Flow (RTOR)		34				220		95				535
Lane Group Flow (vph)	514	2142	0	49	1889	220	205	138	0	152	42	561
Turn Type	Prot	NA		pm+pt	NA	Perm	pm+pt	NA		pm+pt	NA	Perm
Protected Phases	5	2		1	6		7	4		3	8	
Permitted Phases				6		6	4			8		8
Detector Phase	5	2		1	6	6	7	4		3	8	8
Switch Phase												
Minimum Initial (s)	5.0	20.0		5.0	20.0	20.0	5.0	5.0		5.0	5.0	5.0
Minimum Split (s)	10.0	26.0		10.0	26.0	26.0	10.0	11.0		11.0	11.0	11.0
Total Split (s)	20.0	58.0		11.0	49.0	49.0	18.0	13.0		18.0	13.0	13.0
Total Split (%)	20.0%	58.0%		11.0%	49.0%	49.0%	18.0%	13.0%		18.0%	13.0%	13.0%
Yellow Time (s)	3.0	4.0		3.0	4.0	4.0	3.0	4.0		3.0	4.0	4.0
All-Red Time (s)	2.0	2.0		2.0	2.0	2.0	2.0	2.0		2.0	2.0	2.0
Lost Time Adjust (s)	0.0	0.0		0.0	0.0	0.0	0.0	0.0		0.0	0.0	0.0
Total Lost Time (s)	5.0	6.0		5.0	6.0	6.0	5.0	6.0		5.0	6.0	6.0
Lead/Lag	Lead	Lead		Lag	Lag	Lag	Lead	Lag		Lead	Lag	Lag
Lead-Lag Optimize?	Yes	Yes		Yes	Yes	Yes	Yes	Yes		Yes	Yes	Yes
Recall Mode	None	C-Min		None	C-Min	C-Min	None	None		None	None	None
Act Effct Green (s)	16.1	57.3		43.8	42.8	42.8	21.1	7.7		19.1	6.7	6.7
Actuated g/C Ratio	0.16	0.57		0.44	0.43	0.43	0.21	0.08		0.19	0.07	0.07
v/c Ratio	0.93	0.74		0.28	0.87	0.27	0.64	0.64		0.53	0.34	0.82
Control Delay	63.3	20.9		30.3	31.4	3.4	41.7	31.6		37.8	52.1	16.2
Queue Delay	0.0	1.8		0.0	9.4	0.0	0.0	0.0		0.0	0.0	1.0
Total Delay	63.3	22.6		30.3	40.8	3.4	41.7	31.6		37.8	52.1	17.3
LOS	E	C		C	D	A	D	C		D	D	B
Approach Delay		30.5			36.8			37.6			23.3	
Approach LOS		C			D			D			C	
Queue Length 50th (ft)	170	367		17	390	0	109	27		79	26	9
Queue Length 95th (ft)	#284	464		39	459	41	178	#108		136	60	#84
Internal Link Dist (ft)		347			406			277			368	
Turn Bay Length (ft)	300			330			80			120		100
Base Capacity (vph)	552	2878		176	2186	806	332	215		316	130	692
Starvation Cap Reductn	0	535		0	0	0	0	0		0	0	0
Spillback Cap Reductn	0	0		0	294	0	0	0		0	0	30
Storage Cap Reductn	0	0		0	0	0	0	0		0	0	0
Reduced v/c Ratio	0.93	0.91		0.28	1.00	0.27	0.62	0.64		0.48	0.32	0.85

Intersection Summary
 Cycle Length: 100
 Actuated Cycle Length: 100
 Offset: 70 (70%), Referenced to phase 2:EBT and 6:WBTL, Start of Green
 Natural Cycle: 80
 Control Type: Actuated-Coordinated

Timings

2: Allen Way & Founders Parkway (SH 86)

Background Traffic Volumes
Year 2023 - Saturday Peak Hour

Maximum v/c Ratio: 0.93

Intersection Signal Delay: 32.3

Intersection LOS: C

Intersection Capacity Utilization 80.6%

ICU Level of Service D

Analysis Period (min) 15

95th percentile volume exceeds capacity, queue may be longer.

Queue shown is maximum after two cycles.













Splits and Phases: 2: Allen Way & Founders Parkway (SH 86)

→ Ø2 (R) 58 s	↓	↙ Ø1 11 s	↘ Ø3 18 s	↕ Ø4 13 s
↗ Ø5 20 s	↖ Ø6 (R) 49 s	↙ Ø7 18 s	↘ Ø8 13 s	

Timings

Background Traffic Volumes

3: I-25 NB Off-Ramp/I-25 NB On-Ramp & Founders Parkway (SH 86) Year 2023 - Saturday Peak Hour

												
Lane Group	EBL	EBT	EBR	WBL	WBT	WBR	NBL	NBT	NBR	SBL	SBT	SBR
Lane Configurations		↑↑↑	↗		↑↑	↗	↘↘		↘↘			
Traffic Volume (vph)	0	2049	517	0	1387	1059	532	0	398	0	0	0
Future Volume (vph)	0	2049	517	0	1387	1059	532	0	398	0	0	0
Satd. Flow (prot)	0	4787	1362	0	3295	1441	3433	0	2787	0	0	0
Flt Permitted							0.950					
Satd. Flow (perm)	0	4787	1362	0	3295	1441	3433	0	2787	0	0	0
Satd. Flow (RTOR)		6	461		49	474			33			
Lane Group Flow (vph)	0	2283	506	0	1853	806	578	0	433	0	0	0
Turn Type		NA	Free		NA	Free	Prot		Prot			
Protected Phases		2			2		4		4			
Permitted Phases			Free			Free						
Detector Phase		2			2		4		4			
Switch Phase												
Minimum Initial (s)		20.0			20.0		5.0		5.0			
Minimum Split (s)		26.0			26.0		10.5		10.5			
Total Split (s)		68.0			68.0		32.0		32.0			
Total Split (%)		68.0%			68.0%		32.0%		32.0%			
Yellow Time (s)		4.0			4.0		3.5		3.5			
All-Red Time (s)		2.0			2.0		2.0		2.0			
Lost Time Adjust (s)		0.0			0.0		0.0		0.0			
Total Lost Time (s)		6.0			6.0		5.5		5.5			
Lead/Lag												
Lead-Lag Optimize?												
Recall Mode		C-Max			C-Max		None		None			
Act Effct Green (s)		66.2	100.0		66.2	100.0	22.3		22.3			
Actuated g/C Ratio		0.66	1.00		0.66	1.00	0.22		0.22			
v/c Ratio		0.72	0.37		0.84	0.56	0.75		0.67			
Control Delay		13.1	0.8		10.7	3.8	42.7		37.7			
Queue Delay		0.1	0.0		32.6	0.0	0.0		56.5			
Total Delay		13.2	0.8		43.3	3.8	42.7		94.1			
LOS		B	A		D	A	D		F			
Approach Delay		11.0			31.3			64.8				
Approach LOS		B			C			E				
Queue Length 50th (ft)		331	0		604	229	177		132			
Queue Length 95th (ft)		443	0		737	m354	225		180			
Internal Link Dist (ft)		649			347			213			215	
Turn Bay Length (ft)			500						100			
Base Capacity (vph)		3170	1362		2197	1441	909		762			
Starvation Cap Reductn		0	0		458	0	0		0			
Spillback Cap Reductn		123	0		0	0	0		387			
Storage Cap Reductn		0	0		0	0	0		0			
Reduced v/c Ratio		0.75	0.37		1.07	0.56	0.64		1.15			
Intersection Summary												
Cycle Length: 100												
Actuated Cycle Length: 100												
Offset: 80 (80%), Referenced to phase 2:EBWB, Start of Green												
Natural Cycle: 60												
Control Type: Actuated-Coordinated												

Timings

Background Traffic Volumes

3: I-25 NB Off-Ramp/I-25 NB On-Ramp & Founders Parkway (SH 86) Year 2023 - Saturday Peak Hour

Maximum v/c Ratio: 0.84

Intersection Signal Delay: 27.8

Intersection LOS: C

Intersection Capacity Utilization 73.1%

ICU Level of Service D

Analysis Period (min) 15























m Volume for 95th percentile queue is metered by upstream signal.

Splits and Phases: 3: I-25 NB Off-Ramp/I-25 NB On-Ramp & Founders Parkway (SH 86)

  Ø2 (R)	  Ø4
68 s	32 s

Timings
4: Allen Way & Allen Street

Background Traffic Volumes
Year 2023 - Saturday Peak Hour

												
Lane Group	EBL	EBT	EBR	WBL	WBT	WBR	NBL	NBT	NBR	SBL	SBT	SBR
Lane Configurations												
Traffic Volume (vph)	10	55	139	137	56	69	159	392	81	56	363	4
Future Volume (vph)	10	55	139	137	56	69	159	392	81	56	363	4
Satd. Flow (prot)	1770	1663	0	1770	1863	1583	1770	3539	1583	0	3511	0
Flt Permitted	0.508			0.626			0.487				0.853	
Satd. Flow (perm)	946	1663	0	1166	1863	1583	907	3539	1583	0	3016	0
Satd. Flow (RTOR)		151					218		218		2	
Lane Group Flow (vph)	11	211	0	149	61	75	173	426	88	0	460	0
Turn Type	pm+pt	NA		Perm	NA	Perm	Perm	NA	Perm	D.P+P	NA	
Protected Phases	3	8			4			6		5	2	
Permitted Phases	8			4		4	6		6	6		
Detector Phase	3	8		4	4	4	6	6	6	5	2	
Switch Phase												
Minimum Initial (s)	3.0	5.0		5.0	5.0	5.0	5.0	5.0	5.0	3.0	5.0	
Minimum Split (s)	8.0	10.0		10.0	10.0	10.0	10.0	10.0	10.0	8.0	10.0	
Total Split (s)	12.0	27.0		15.0	15.0	15.0	21.0	21.0	21.0	12.0	33.0	
Total Split (%)	20.0%	45.0%		25.0%	25.0%	25.0%	35.0%	35.0%	35.0%	20.0%	55.0%	
Yellow Time (s)	3.0	3.0		3.0	3.0	3.0	3.0	3.0	3.0	3.0	3.0	
All-Red Time (s)	2.0	2.0		2.0	2.0	2.0	2.0	2.0	2.0	2.0	2.0	
Lost Time Adjust (s)	0.0	0.0		0.0	0.0	0.0	0.0	0.0	0.0		0.0	
Total Lost Time (s)	5.0	5.0		5.0	5.0	5.0	5.0	5.0	5.0		5.0	
Lead/Lag	Lead			Lag	Lag	Lag	Lag	Lag	Lag	Lead		
Lead-Lag Optimize?	Yes			Yes	Yes	Yes	Yes	Yes	Yes	Yes		
Recall Mode	None	None		None	None	None	C-Min	C-Min	C-Min	None	C-Min	
Act Effct Green (s)	14.4	14.4		12.1	12.1	12.1	35.6	35.6	35.6		35.6	
Actuated g/C Ratio	0.24	0.24		0.20	0.20	0.20	0.59	0.59	0.59		0.59	
v/c Ratio	0.04	0.41		0.64	0.16	0.15	0.32	0.20	0.09		0.26	
Control Delay	14.5	8.2		37.4	20.6	0.7	10.0	6.9	0.2		7.3	
Queue Delay	0.0	0.0		0.0	0.0	0.0	0.0	0.0	0.0		0.0	
Total Delay	14.5	8.2		37.4	20.6	0.7	10.0	6.9	0.2		7.3	
LOS	B	A		D	C	A	A	A	A		A	
Approach Delay		8.5			24.1			6.8			7.3	
Approach LOS		A			C			A			A	
Queue Length 50th (ft)	3	17		47	18	0	27	32	0		35	
Queue Length 95th (ft)	11	52		#134	47	0	84	71	0		80	
Internal Link Dist (ft)		422			420			368			300	
Turn Bay Length (ft)	60			95		65	70		95			
Base Capacity (vph)	322	705		241	386	501	538	2102	1028		1792	
Starvation Cap Reductn	0	0		0	0	0	0	0	0		0	
Spillback Cap Reductn	0	0		0	0	0	0	0	0		0	
Storage Cap Reductn	0	0		0	0	0	0	0	0		0	
Reduced v/c Ratio	0.03	0.30		0.62	0.16	0.15	0.32	0.20	0.09		0.26	

Intersection Summary

Cycle Length: 60
 Actuated Cycle Length: 60
 Offset: 31 (52%), Referenced to phase 2:SBT and 6:NBSB, Start of Green
 Natural Cycle: 60
 Control Type: Actuated-Coordinated

Timings

4: Allen Way & Allen Street

Background Traffic Volumes

Year 2023 - Saturday Peak Hour

Maximum v/c Ratio: 0.64

Intersection Signal Delay: 10.2

Intersection LOS: B

Intersection Capacity Utilization 58.3%







ICU Level of Service B

Analysis Period (min) 15

95th percentile volume exceeds capacity, queue may be longer.

Queue shown is maximum after two cycles.

Splits and Phases: 4: Allen Way & Allen Street

 Ø2 (R)		 Ø3	 Ø4
33 s		12 s	15 s
 Ø5		 Ø8	
12 s	21 s	27 s	

HCM 6th TWSC
5: Allen Street & Alexander Place

Background Traffic Volumes
Year 2023 - Saturday Peak Hour

Intersection												
Int Delay, s/veh	7.4											
Movement	EBL	EBT	EBR	WBL	WBT	WBR	NBL	NBT	NBR	SBL	SBT	SBR
Lane Configurations		↔		↵	↶		↵	↶	↷	↵	↶	
Traffic Vol, veh/h	77	4	49	130	7	42	58	136	105	46	135	27
Future Vol, veh/h	77	4	49	130	7	42	58	136	105	46	135	27
Conflicting Peds, #/hr	0	0	0	0	0	0	0	0	0	0	0	0
Sign Control	Stop	Stop	Stop	Stop	Stop	Stop	Free	Free	Free	Free	Free	Free
RT Channelized	-	-	None	-	-	None	-	-	None	-	-	None
Storage Length	-	-	-	60	-	-	75	-	75	80	-	-
Veh in Median Storage, #	-	0	-	-	0	-	-	0	-	-	0	-
Grade, %	-	0	-	-	0	-	-	0	-	-	0	-
Peak Hour Factor	92	92	92	92	92	92	92	92	92	92	92	92
Heavy Vehicles, %	2	2	2	2	2	2	2	2	2	2	2	2
Mvmt Flow	84	4	53	141	8	46	63	148	114	50	147	29

Major/Minor	Minor2		Minor1		Major1		Major2					
Conflicting Flow All	620	650	162	564	550	148	176	0	0	262	0	0
Stage 1	262	262	-	274	274	-	-	-	-	-	-	-
Stage 2	358	388	-	290	276	-	-	-	-	-	-	-
Critical Hdwy	7.12	6.52	6.22	7.12	6.52	6.22	4.12	-	-	4.12	-	-
Critical Hdwy Stg 1	6.12	5.52	-	6.12	5.52	-	-	-	-	-	-	-
Critical Hdwy Stg 2	6.12	5.52	-	6.12	5.52	-	-	-	-	-	-	-
Follow-up Hdwy	3.518	4.018	3.318	3.518	4.018	3.318	2.218	-	-	2.218	-	-
Pot Cap-1 Maneuver	400	388	883	436	443	899	1400	-	-	1302	-	-
Stage 1	743	691	-	732	683	-	-	-	-	-	-	-
Stage 2	660	609	-	718	682	-	-	-	-	-	-	-
Platoon blocked, %								-	-	-	-	-
Mov Cap-1 Maneuver	351	357	883	381	407	899	1400	-	-	1302	-	-
Mov Cap-2 Maneuver	351	357	-	381	407	-	-	-	-	-	-	-
Stage 1	710	665	-	699	652	-	-	-	-	-	-	-
Stage 2	591	582	-	645	656	-	-	-	-	-	-	-

Approach	EB		WB		NB		SB	
HCM Control Delay, s	16.5		17.2		1.5		1.7	
HCM LOS	C		C					

Minor Lane/Major Mvmt	NBL	NBT	NBR	EBLn1	WBLn1	WBLn2	SBL	SBT	SBR
Capacity (veh/h)	1400	-	-	454	381	767	1302	-	-
HCM Lane V/C Ratio	0.045	-	-	0.311	0.371	0.069	0.038	-	-
HCM Control Delay (s)	7.7	-	-	16.5	19.9	10	7.9	-	-
HCM Lane LOS	A	-	-	C	C	B	A	-	-
HCM 95th %tile Q(veh)	0.1	-	-	1.3	1.7	0.2	0.1	-	-

HCM 6th AWSC
6: Allen Street & Front Street

Background Traffic Volumes
Year 2023 - Saturday Peak Hour

Intersection	
Intersection Delay, s/veh	11.5
Intersection LOS	B

Movement	EBL	EBR	NBL	NBT	SBT	SBR
Lane Configurations	↙	↗	↙	↗	↗	↗
Traffic Vol, veh/h	202	99	83	176	168	179
Future Vol, veh/h	202	99	83	176	168	179
Peak Hour Factor	0.92	0.92	0.92	0.92	0.92	0.92
Heavy Vehicles, %	2	2	2	2	2	2
Mvmt Flow	220	108	90	191	183	195
Number of Lanes	1	1	1	1	1	1

Approach	EB	NB	SB
Opposing Approach		SB	NB
Opposing Lanes	0	2	2
Conflicting Approach Left	SB	EB	
Conflicting Lanes Left	2	2	0
Conflicting Approach Right	NB		EB
Conflicting Lanes Right	2	0	2
HCM Control Delay	12.6	11.3	10.7
HCM LOS	B	B	B

Lane	NBLn1	NBLn2	EBLn1	EBLn2	SBLn1	SBLn2
Vol Left, %	100%	0%	100%	0%	0%	0%
Vol Thru, %	0%	100%	0%	0%	100%	0%
Vol Right, %	0%	0%	0%	100%	0%	100%
Sign Control	Stop	Stop	Stop	Stop	Stop	Stop
Traffic Vol by Lane	83	176	202	99	168	179
LT Vol	83	0	202	0	0	0
Through Vol	0	176	0	0	168	0
RT Vol	0	0	0	99	0	179
Lane Flow Rate	90	191	220	108	183	195
Geometry Grp	7	7	7	7	7	7
Degree of Util (X)	0.165	0.322	0.411	0.165	0.303	0.285
Departure Headway (Hd)	6.566	6.058	6.739	5.527	5.976	5.266
Convergence, Y/N	Yes	Yes	Yes	Yes	Yes	Yes
Cap	547	593	536	649	603	683
Service Time	4.302	3.794	4.474	3.261	3.71	3
HCM Lane V/C Ratio	0.165	0.322	0.41	0.166	0.303	0.286
HCM Control Delay	10.6	11.7	14.1	9.4	11.3	10.1
HCM Lane LOS	B	B	B	A	B	B
HCM 95th-tile Q	0.6	1.4	2	0.6	1.3	1.2

HCM 6th TWSC
7: Private Access/Brewer Court & Alexander Place

Background Traffic Volumes
Year 2023 - Saturday Peak Hour

Intersection												
Int Delay, s/veh	7.3											
Movement	EBL	EBT	EBR	WBL	WBT	WBR	NBL	NBT	NBR	SBL	SBT	SBR
Lane Configurations	↕			↕			↕			↕		
Traffic Vol, veh/h	143	16	4	0	29	0	3	0	0	0	0	165
Future Vol, veh/h	143	16	4	0	29	0	3	0	0	0	0	165
Conflicting Peds, #/hr	0	0	0	0	0	0	0	0	0	0	0	0
Sign Control	Free	Free	Free	Free	Free	Free	Stop	Stop	Stop	Stop	Stop	Stop
RT Channelized	-	-	None	-	-	None	-	-	None	-	-	None
Storage Length	-	-	-	-	-	-	-	-	-	-	-	-
Veh in Median Storage, #	-	0	-	-	0	-	-	0	-	-	0	-
Grade, %	-	0	-	-	0	-	-	0	-	-	0	-
Peak Hour Factor	92	92	92	92	92	92	92	92	92	92	92	92
Heavy Vehicles, %	2	2	2	2	2	2	2	2	2	2	2	2
Mvmt Flow	155	17	4	0	32	0	3	0	0	0	0	179





























Major/Minor	Major1		Major2		Minor1		Minor2					
Conflicting Flow All	32	0	0	21	0	0	451	361	19	361	363	32
Stage 1	-	-	-	-	-	-	329	329	-	32	32	-
Stage 2	-	-	-	-	-	-	122	32	-	329	331	-
Critical Hdwy	4.12	-	-	4.12	-	-	7.12	6.52	6.22	7.12	6.52	6.22
Critical Hdwy Stg 1	-	-	-	-	-	-	6.12	5.52	-	6.12	5.52	-
Critical Hdwy Stg 2	-	-	-	-	-	-	6.12	5.52	-	6.12	5.52	-
Follow-up Hdwy	2.218	-	-	2.218	-	-	3.518	4.018	3.318	3.518	4.018	3.318
Pot Cap-1 Maneuver	1580	-	-	1595	-	-	519	566	1059	595	565	1042
Stage 1	-	-	-	-	-	-	684	646	-	984	868	-
Stage 2	-	-	-	-	-	-	882	868	-	684	645	-
Platoon blocked, %	-	-	-	-	-	-	-	-	-	-	-	-
Mov Cap-1 Maneuver	1580	-	-	1595	-	-	397	510	1059	550	509	1042
Mov Cap-2 Maneuver	-	-	-	-	-	-	397	510	-	550	509	-
Stage 1	-	-	-	-	-	-	616	582	-	887	868	-
Stage 2	-	-	-	-	-	-	730	868	-	616	581	-

Approach	EB	WB	NB	SB
HCM Control Delay, s	6.6	0	14.1	9.2
HCM LOS			B	A

Minor Lane/Major Mvmt	NBLn1	EBL	EBT	EBR	WBL	WBT	WBR	SBLn1
Capacity (veh/h)	397	1580	-	-	1595	-	-	1042
HCM Lane V/C Ratio	0.008	0.098	-	-	-	-	-	0.172
HCM Control Delay (s)	14.1	7.5	0	-	0	-	-	9.2
HCM Lane LOS	B	A	A	-	A	-	-	A
HCM 95th %tile Q(veh)	0	0.3	-	-	0	-	-	0.6

Timings
1: Front Street & Founders Parkway (SH 86)

Background Traffic Volumes
Year 2041 - AM Peak Hour

												
Lane Group	EBL	EBT	EBR	WBL	WBT	WBR	NBL	NBT	NBR	SBL	SBT	SBR
Lane Configurations	 				 		 	  			  	
Traffic Volume (vph)	255	56	53	24	37	85	84	2179	13	75	1287	237
Future Volume (vph)	255	56	53	24	37	85	84	2179	13	75	1287	237
Satd. Flow (prot)	3433	1863	1583	1770	3168	0	3433	5080	0	1770	5085	1583
Flt Permitted	0.423			0.717			0.151			0.055		
Satd. Flow (perm)	1529	1863	1583	1336	3168	0	546	5080	0	102	5085	1583
Satd. Flow (RTOR)			118		76			1				258
Lane Group Flow (vph)	277	61	58	26	132	0	91	2382	0	82	1399	258
Turn Type	pm+pt	NA	Perm	pm+pt	NA		pm+pt	NA		pm+pt	NA	Perm
Protected Phases	7	4		3	8		1	6		5	2	
Permitted Phases	4		4	8			6			2		2
Detector Phase	7	4	4	3	8		1	6		5	2	2
Switch Phase												
Minimum Initial (s)	3.0	5.0	5.0	3.0	5.0		3.0	20.0		3.0	20.0	20.0
Minimum Split (s)	10.0	11.0	11.0	10.0	11.0		10.0	26.0		10.0	26.0	26.0
Total Split (s)	16.0	19.0	19.0	10.0	13.0		10.0	77.0		14.0	81.0	81.0
Total Split (%)	13.3%	15.8%	15.8%	8.3%	10.8%		8.3%	64.2%		11.7%	67.5%	67.5%
Yellow Time (s)	3.0	4.0	4.0	3.0	4.0		3.0	4.0		3.0	4.0	4.0
All-Red Time (s)	2.0	2.0	2.0	2.0	2.0		2.0	2.0		2.0	2.0	2.0
Lost Time Adjust (s)	0.0	0.0	0.0	0.0	0.0		0.0	0.0		0.0	0.0	0.0
Total Lost Time (s)	5.0	6.0	6.0	5.0	6.0		5.0	6.0		5.0	6.0	6.0
Lead/Lag	Lead	Lag	Lag	Lead	Lag		Lead	Lag		Lead	Lag	Lag
Lead-Lag Optimize?	Yes	Yes	Yes	Yes	Yes		Yes	Yes		Yes	Yes	Yes
Recall Mode	None	None	None	None	None		None	C-Max		None	C-Max	C-Max
Act Effct Green (s)	23.6	16.6	16.6	12.6	6.6		80.4	75.3		83.5	75.2	75.2
Actuated g/C Ratio	0.20	0.14	0.14	0.10	0.06		0.67	0.63		0.70	0.63	0.63
v/c Ratio	0.58	0.24	0.18	0.16	0.54		0.18	0.75		0.47	0.44	0.24
Control Delay	47.6	50.9	1.2	42.2	33.7		6.1	18.4		20.9	12.1	1.6
Queue Delay	0.0	0.0	0.0	0.0	0.0		0.0	0.0		0.0	0.0	0.0
Total Delay	47.6	50.9	1.2	42.2	33.7		6.1	18.4		20.9	12.1	1.6
LOS	D	D	A	D	C		A	B		C	B	A
Approach Delay		41.3			35.1			18.0			11.0	
Approach LOS		D			D			B			B	
Queue Length 50th (ft)	96	44	0	17	22		9	469		17	191	0
Queue Length 95th (ft)	139	88	0	42	55		16	556		59	223	30
Internal Link Dist (ft)		695			413			423			624	
Turn Bay Length (ft)	285		285	195			175			455		
Base Capacity (vph)	474	256	320	158	256		492	3186		197	3186	1088
Starvation Cap Reductn	0	0	0	0	0		0	0		0	0	0
Spillback Cap Reductn	0	0	0	0	0		0	0		0	0	0
Storage Cap Reductn	0	0	0	0	0		0	0		0	0	0
Reduced v/c Ratio	0.58	0.24	0.18	0.16	0.52		0.18	0.75		0.42	0.44	0.24

Intersection Summary

Cycle Length: 120
 Actuated Cycle Length: 120
 Offset: 42 (35%), Referenced to phase 2:SBTL and 6:NBTL, Start of Green
 Natural Cycle: 70
 Control Type: Actuated-Coordinated

Timings

1: Front Street & Founders Parkway (SH 86)

Background Traffic Volumes
Year 2041 - AM Peak Hour

Maximum v/c Ratio: 0.75

Intersection Signal Delay: 17.9









Intersection LOS: B

Intersection Capacity Utilization 76.3%

ICU Level of Service D































Analysis Period (min) 15

Splits and Phases: 1: Front Street & Founders Parkway (SH 86)

 Ø1	 Ø2 (R)	 Ø3	 Ø4
10 s	81 s	10 s	19 s
 Ø5	 Ø6 (R)	 Ø7	 Ø8
14 s	77 s	16 s	13 s

Timings
2: Allen Way & Founders Parkway (SH 86)

Background Traffic Volumes
Year 2041 - AM Peak Hour

												
Lane Group	EBL	EBT	EBR	WBL	WBT	WBR	NBL	NBT	NBR	SBL	SBT	SBR
Lane Configurations	 	  			  		 			 		 
Traffic Volume (vph)	368	1418	197	55	2287	195	140	28	269	95	24	427
Future Volume (vph)	368	1418	197	55	2287	195	140	28	269	95	24	427
Satd. Flow (prot)	3433	5085	1583	1770	5085	1583	3433	1609	0	3433	1863	2787
Flt Permitted	0.950			0.146			0.740			0.222		
Satd. Flow (perm)	3433	5085	1583	272	5085	1583	2674	1609	0	802	1863	2787
Satd. Flow (RTOR)			214			154		102				428
Lane Group Flow (vph)	400	1541	214	60	2486	212	152	322	0	103	26	464
Turn Type	Prot	NA	Perm	pm+pt	NA	Perm	pm+pt	NA		pm+pt	NA	Perm
Protected Phases	5	2		1	6		7	4		3	8	
Permitted Phases			2	6		6	4			8		8
Detector Phase	5	2	2	1	6	6	7	4		3	8	8
Switch Phase												
Minimum Initial (s)	5.0	20.0	20.0	5.0	20.0	20.0	5.0	5.0		5.0	5.0	5.0
Minimum Split (s)	10.0	26.0	26.0	10.0	26.0	26.0	10.0	11.0		11.0	11.0	11.0
Total Split (s)	20.0	76.0	76.0	10.0	66.0	66.0	10.0	23.0		11.0	24.0	24.0
Total Split (%)	16.7%	63.3%	63.3%	8.3%	55.0%	55.0%	8.3%	19.2%		9.2%	20.0%	20.0%
Yellow Time (s)	3.0	4.0	4.0	3.0	4.0	4.0	3.0	4.0		3.0	4.0	4.0
All-Red Time (s)	2.0	2.0	2.0	2.0	2.0	2.0	2.0	2.0		2.0	2.0	2.0
Lost Time Adjust (s)	0.0	0.0	0.0	0.0	0.0	0.0	0.0	0.0		0.0	0.0	0.0
Total Lost Time (s)	5.0	6.0	6.0	5.0	6.0	6.0	5.0	6.0		5.0	6.0	6.0
Lead/Lag	Lead	Lead	Lead	Lag	Lag	Lag	Lead	Lag		Lead	Lag	Lag
Lead-Lag Optimize?	Yes	Yes	Yes	Yes	Yes	Yes	Yes	Yes		Yes	Yes	Yes
Recall Mode	None	C-Min	C-Min	None	C-Min	C-Min	None	None		None	None	None
Act Effct Green (s)	15.0	58.2	58.2	61.0	60.0	60.0	23.0	17.0		25.0	18.0	18.0
Actuated g/C Ratio	0.12	0.48	0.48	0.51	0.50	0.50	0.19	0.14		0.21	0.15	0.15
v/c Ratio	0.93	0.62	0.24	0.16	0.98	0.24	0.28	1.02		0.35	0.09	0.59
Control Delay	83.0	21.3	1.7	22.2	43.0	5.8	38.3	91.5		40.2	47.1	13.0
Queue Delay	0.0	0.1	0.0	0.0	0.0	0.0	0.1	0.0		0.0	0.0	0.3
Total Delay	83.0	21.4	1.7	22.2	43.0	5.8	38.4	91.5		40.2	47.1	13.2
LOS	F	C	A	C	D	A	D	F		D	D	B
Approach Delay		30.9			39.7			74.5			19.4	
Approach LOS		C			D			E			B	
Queue Length 50th (ft)	156	301	0	23	668	23	48	~192		34	18	0
Queue Length 95th (ft)	#257	282	22	46	#809	64	77	#379		60	m49	89
Internal Link Dist (ft)		347			406			277			368	
Turn Bay Length (ft)	300			330			80			120		100
Base Capacity (vph)	429	3051	1035	373	2542	868	544	315		298	279	781
Starvation Cap Reductn	0	432	0	0	0	0	0	0		0	0	0
Spillback Cap Reductn	0	0	0	0	0	0	47	0		0	0	49
Storage Cap Reductn	0	0	0	0	0	0	0	0		0	0	0
Reduced v/c Ratio	0.93	0.59	0.21	0.16	0.98	0.24	0.31	1.02		0.35	0.09	0.63

Intersection Summary

Cycle Length: 120
 Actuated Cycle Length: 120
 Offset: 36 (30%), Referenced to phase 2:EBT and 6:WBTL, Start of Green
 Natural Cycle: 100
 Control Type: Actuated-Coordinated

Timings
 2: Allen Way & Founders Parkway (SH 86)

Background Traffic Volumes
 Year 2041 - AM Peak Hour

Maximum v/c Ratio: 1.02

Intersection Signal Delay: 37.3

Intersection LOS: D

Intersection Capacity Utilization 95.3%

ICU Level of Service F

Analysis Period (min) 15

~ Volume exceeds capacity, queue is theoretically infinite.

Queue shown is maximum after two cycles.

95th percentile volume exceeds capacity, queue may be longer.

Queue shown is maximum after two cycles.

m Volume for 95th percentile queue is metered by upstream signal.

Splits and Phases: 2: Allen Way & Founders Parkway (SH 86)



















76 s		10 s		11 s		23 s	
20 s		66 s		10 s		24 s	

Timings

Background Traffic Volumes

3: I-25 NB Off-Ramp/I-25 NB On-Ramp & Founders Parkway (SH 86)

Year 2041 - AM Peak Hour

												
Lane Group	EBL	EBT	EBR	WBL	WBT	WBR	NBL	NBT	NBR	SBL	SBT	SBR
Lane Configurations												
Traffic Volume (vph)	0	1449	785	0	1103	1895	320	0	321	0	0	0
Future Volume (vph)	0	1449	785	0	1103	1895	320	0	321	0	0	0
Satd. Flow (prot)	0	4691	1362	0	3156	1441	3433	0	2787	0	0	0
Flt Permitted							0.950					
Satd. Flow (perm)	0	4691	1362	0	3156	1441	3433	0	2787	0	0	0
Satd. Flow (RTOR)		90	546		535	1030			120			
Lane Group Flow (vph)	0	1882	546	0	2229	1030	348	0	349	0	0	0
Turn Type		NA	Free		NA	Free	Prot		Prot			
Protected Phases		2			2		4		4			
Permitted Phases			Free			Free						
Detector Phase		2			2		4		4			
Switch Phase												
Minimum Initial (s)		20.0			20.0		5.0		5.0			
Minimum Split (s)		26.0			26.0		10.5		10.5			
Total Split (s)		97.0			97.0		23.0		23.0			
Total Split (%)		80.8%			80.8%		19.2%		19.2%			
Yellow Time (s)		4.0			4.0		3.5		3.5			
All-Red Time (s)		2.0			2.0		2.0		2.0			
Lost Time Adjust (s)		0.0			0.0		0.0		0.0			
Total Lost Time (s)		6.0			6.0		5.5		5.5			
Lead/Lag												
Lead-Lag Optimize?												
Recall Mode		C-Max			C-Max		None		None			
Act Effct Green (s)		92.4	120.0		92.4	120.0	16.1		16.1			
Actuated g/C Ratio		0.77	1.00		0.77	1.00	0.13		0.13			
v/c Ratio		0.52	0.40		0.87	0.71	0.75		0.73			
Control Delay		5.7	0.9		10.1	9.4	60.9		41.8			
Queue Delay		0.0	0.0		13.4	0.0	0.0		0.0			
Total Delay		5.7	0.9		23.4	9.4	60.9		41.8			
LOS		A	A		C	A	E		D			
Approach Delay		4.6			19.0			51.3				
Approach LOS		A			B			D				
Queue Length 50th (ft)		181	0		234	226	134		96			
Queue Length 95th (ft)		212	0		m203	m214	185		154			
Internal Link Dist (ft)		649			347			213			215	
Turn Bay Length (ft)			500						100			
Base Capacity (vph)		3631	1362		2552	1441	500		508			
Starvation Cap Reductn		0	0		358	0	0		0			
Spillback Cap Reductn		0	0		0	0	0		0			
Storage Cap Reductn		0	0		0	0	0		0			
Reduced v/c Ratio		0.52	0.40		1.02	0.71	0.70		0.69			
Intersection Summary												
Cycle Length: 120												
Actuated Cycle Length: 120												
Offset: 35 (29%), Referenced to phase 2:EBWB, Start of Green												
Natural Cycle: 70												
Control Type: Actuated-Coordinated												

Timings

Background Traffic Volumes

3: I-25 NB Off-Ramp/I-25 NB On-Ramp & Founders Parkway (SH 86)

Year 2041 - AM Peak Hour

Maximum v/c Ratio: 0.87

Intersection Signal Delay: 17.1

Intersection LOS: B

Intersection Capacity Utilization 68.2%

ICU Level of Service C

Analysis Period (min) 15























m Volume for 95th percentile queue is metered by upstream signal.

Splits and Phases: 3: I-25 NB Off-Ramp/I-25 NB On-Ramp & Founders Parkway (SH 86)

 Ø2 (R)	 Ø4
97 s	23 s

Timings
4: Allen Way & Allen Street

Background Traffic Volumes
Year 2041 - AM Peak Hour

												
Lane Group	EBL	EBT	EBR	WBL	WBT	WBR	NBL	NBT	NBR	SBL	SBT	SBR
Lane Configurations												
Traffic Volume (vph)	9	16	131	79	24	74	170	368	54	30	321	5
Future Volume (vph)	9	16	131	79	24	74	170	368	54	30	321	5
Satd. Flow (prot)	1770	1613	0	1770	1863	1583	1770	3539	1583	0	3518	0
Flt Permitted	0.447			0.656			0.523				0.904	
Satd. Flow (perm)	833	1613	0	1222	1863	1583	974	3539	1583	0	3193	0
Satd. Flow (RTOR)		142				218			218		3	
Lane Group Flow (vph)	10	159	0	86	26	80	185	400	59	0	387	0
Turn Type	pm+pt	NA		Perm	NA	Perm	Perm	NA	Perm	D.P+P	NA	
Protected Phases	3	8			4			6		5	2	
Permitted Phases	8			4		4	6		6	6		
Detector Phase	3	8		4	4	4	6	6	6	5	2	
Switch Phase												
Minimum Initial (s)	3.0	5.0		5.0	5.0	5.0	5.0	5.0	5.0	3.0	5.0	
Minimum Split (s)	8.0	10.0		10.0	10.0	10.0	10.0	10.0	10.0	8.0	10.0	
Total Split (s)	8.0	22.0		14.0	14.0	14.0	30.0	30.0	30.0	8.0	38.0	
Total Split (%)	13.3%	36.7%		23.3%	23.3%	23.3%	50.0%	50.0%	50.0%	13.3%	63.3%	
Yellow Time (s)	3.0	3.0		3.0	3.0	3.0	3.0	3.0	3.0	3.0	3.0	
All-Red Time (s)	2.0	2.0		2.0	2.0	2.0	2.0	2.0	2.0	2.0	2.0	
Lost Time Adjust (s)	0.0	0.0		0.0	0.0	0.0	0.0	0.0	0.0		0.0	
Total Lost Time (s)	5.0	5.0		5.0	5.0	5.0	5.0	5.0	5.0		5.0	
Lead/Lag	Lead			Lag	Lag	Lag	Lag	Lag	Lag	Lead		
Lead-Lag Optimize?	Yes			Yes	Yes	Yes	Yes	Yes	Yes	Yes		
Recall Mode	None	None		None	None	None	C-Min	C-Min	C-Min	None	C-Min	
Act Effct Green (s)	11.0	11.0		8.7	8.7	8.7	42.1	42.1	42.1		42.1	
Actuated g/C Ratio	0.18	0.18		0.14	0.14	0.14	0.70	0.70	0.70		0.70	
v/c Ratio	0.04	0.39		0.49	0.10	0.19	0.27	0.16	0.05		0.17	
Control Delay	16.7	7.5		32.8	22.2	1.0	5.0	2.3	0.1		5.3	
Queue Delay	0.0	0.0		0.0	0.0	0.0	0.0	0.0	0.0		0.0	
Total Delay	16.7	7.5		32.8	22.2	1.0	5.0	2.3	0.1		5.3	
LOS	B	A		C	C	A	A	A	A		A	
Approach Delay		8.0			18.1			2.9			5.3	
Approach LOS		A			B			A			A	
Queue Length 50th (ft)	3	5		29	8	0	24	18	0		21	
Queue Length 95th (ft)	11	37		67	26	0	m23	m23	m0		63	
Internal Link Dist (ft)		422			420			368			300	
Turn Bay Length (ft)	60			95		65	70		95			
Base Capacity (vph)	243	578		196	299	437	683	2484	1176		2284	
Starvation Cap Reductn	0	0		0	0	0	0	0	0		0	
Spillback Cap Reductn	0	0		0	0	0	0	0	0		0	
Storage Cap Reductn	0	0		0	0	0	0	0	0		0	
Reduced v/c Ratio	0.04	0.28		0.44	0.09	0.18	0.27	0.16	0.05		0.17	

Intersection Summary

Cycle Length: 60
 Actuated Cycle Length: 60
 Offset: 31 (52%), Referenced to phase 2:SBT and 6:NBSB, Start of Green
 Natural Cycle: 50
 Control Type: Actuated-Coordinated

Timings
 4: Allen Way & Allen Street

Background Traffic Volumes
 Year 2041 - AM Peak Hour

Maximum v/c Ratio: 0.49
 Intersection Signal Delay: 6.3 Intersection LOS: A
 Intersection Capacity Utilization 50.0% ICU Level of Service A
 Analysis Period (min) 15
 m Volume for 95th percentile queue is metered by upstream signal.

Splits and Phases: 4: Allen Way & Allen Street

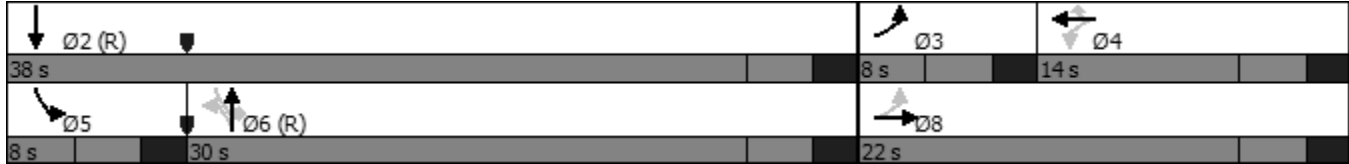

HCM 6th TWSC
5: Allen Street & Alexander Place

Background Traffic Volumes
Year 2041 - AM Peak Hour

Intersection												
Int Delay, s/veh	5.5											
Movement	EBL	EBT	EBR	WBL	WBT	WBR	NBL	NBT	NBR	SBL	SBT	SBR
Lane Configurations		↔		↵	↶		↵	↑	↶	↵	↶	
Traffic Vol, veh/h	39	3	26	38	3	108	33	103	60	44	47	21
Future Vol, veh/h	39	3	26	38	3	108	33	103	60	44	47	21
Conflicting Peds, #/hr	0	0	0	0	0	0	0	0	0	0	0	0
Sign Control	Stop	Stop	Stop	Stop	Stop	Stop	Free	Free	Free	Free	Free	Free
RT Channelized	-	-	None	-	-	None	-	-	None	-	-	None
Storage Length	-	-	-	60	-	-	75	-	75	80	-	-
Veh in Median Storage, #	-	0	-	-	0	-	-	0	-	-	0	-
Grade, %	-	0	-	-	0	-	-	0	-	-	0	-
Peak Hour Factor	92	92	92	92	92	92	92	92	92	92	92	92
Heavy Vehicles, %	2	2	2	2	2	2	2	2	2	2	2	2
Mvmt Flow	42	3	28	41	3	117	36	112	65	48	51	23

Major/Minor	Minor2		Minor1		Major1		Major2					
Conflicting Flow All	436	408	63	358	354	112	74	0	0	177	0	0
Stage 1	159	159	-	184	184	-	-	-	-	-	-	-
Stage 2	277	249	-	174	170	-	-	-	-	-	-	-
Critical Hdwy	7.12	6.52	6.22	7.12	6.52	6.22	4.12	-	-	4.12	-	-
Critical Hdwy Stg 1	6.12	5.52	-	6.12	5.52	-	-	-	-	-	-	-
Critical Hdwy Stg 2	6.12	5.52	-	6.12	5.52	-	-	-	-	-	-	-
Follow-up Hdwy	3.518	4.018	3.318	3.518	4.018	3.318	2.218	-	-	2.218	-	-
Pot Cap-1 Maneuver	531	533	1002	597	571	941	1526	-	-	1399	-	-
Stage 1	843	766	-	818	747	-	-	-	-	-	-	-
Stage 2	729	701	-	828	758	-	-	-	-	-	-	-
Platoon blocked, %								-	-	-	-	-
Mov Cap-1 Maneuver	442	503	1002	552	538	941	1526	-	-	1399	-	-
Mov Cap-2 Maneuver	442	503	-	552	538	-	-	-	-	-	-	-
Stage 1	823	740	-	798	729	-	-	-	-	-	-	-
Stage 2	620	684	-	774	732	-	-	-	-	-	-	-

Approach	EB	WB	NB	SB
HCM Control Delay, s	12.3	10.1	1.2	3
HCM LOS	B	B		

Minor Lane/Major Mvmt	NBL	NBT	NBR	EBLn1	WBLn1	WBLn2	SBL	SBT	SBR
Capacity (veh/h)	1526	-	-	566	552	922	1399	-	-
HCM Lane V/C Ratio	0.024	-	-	0.131	0.075	0.131	0.034	-	-
HCM Control Delay (s)	7.4	-	-	12.3	12	9.5	7.7	-	-
HCM Lane LOS	A	-	-	B	B	A	A	-	-
HCM 95th %tile Q(veh)	0.1	-	-	0.4	0.2	0.5	0.1	-	-

HCM 6th AWSC
6: Allen Street & Front Street

Background Traffic Volumes
Year 2041 - AM Peak Hour

Intersection	
Intersection Delay, s/veh	8.8
Intersection LOS	A

Movement	EBL	EBR	NBL	NBT	SBT	SBR
Lane Configurations	↙	↗	↙	↗	↗	↗
Traffic Vol, veh/h	86	57	78	131	87	63
Future Vol, veh/h	86	57	78	131	87	63
Peak Hour Factor	0.92	0.92	0.92	0.92	0.92	0.92
Heavy Vehicles, %	2	2	2	2	2	2
Mvmt Flow	93	62	85	142	95	68
Number of Lanes	1	1	1	1	1	1

Approach	EB	NB	SB
Opposing Approach		SB	NB
Opposing Lanes	0	2	2
Conflicting Approach Left	SB	EB	
Conflicting Lanes Left	2	2	0
Conflicting Approach Right	NB		EB
Conflicting Lanes Right	2	0	2
HCM Control Delay	9	9.1	8.2
HCM LOS	A	A	A

Lane	NBLn1	NBLn2	EBLn1	EBLn2	SBLn1	SBLn2
Vol Left, %	100%	0%	100%	0%	0%	0%
Vol Thru, %	0%	100%	0%	0%	100%	0%
Vol Right, %	0%	0%	0%	100%	0%	100%
Sign Control	Stop	Stop	Stop	Stop	Stop	Stop
Traffic Vol by Lane	78	131	86	57	87	63
LT Vol	78	0	86	0	0	0
Through Vol	0	131	0	0	87	0
RT Vol	0	0	0	57	0	63
Lane Flow Rate	85	142	93	62	95	68
Geometry Grp	7	7	7	7	7	7
Degree of Util (X)	0.132	0.202	0.155	0.082	0.136	0.085
Departure Headway (Hd)	5.611	5.108	5.97	4.765	5.188	4.484
Convergence, Y/N	Yes	Yes	Yes	Yes	Yes	Yes
Cap	639	702	600	750	690	798
Service Time	3.345	2.842	3.709	2.503	2.924	2.219
HCM Lane V/C Ratio	0.133	0.202	0.155	0.083	0.138	0.085
HCM Control Delay	9.2	9.1	9.8	7.9	8.7	7.6
HCM Lane LOS	A	A	A	A	A	A
HCM 95th-tile Q	0.5	0.8	0.5	0.3	0.5	0.3

HCM 6th TWSC
7: Private Access/Brewer Court & Alexander Place

Background Traffic Volumes
Year 2041 - AM Peak Hour

Intersection												
Int Delay, s/veh	5.1											
Movement	EBL	EBT	EBR	WBL	WBT	WBR	NBL	NBT	NBR	SBL	SBT	SBR
Lane Configurations	↕			↕			↕			↕		
Traffic Vol, veh/h	54	15	41	0	15	0	17	2	0	0	2	38
Future Vol, veh/h	54	15	41	0	15	0	17	2	0	0	2	38
Conflicting Peds, #/hr	0	0	0	0	0	0	0	0	0	0	0	0
Sign Control	Free	Free	Free	Free	Free	Free	Stop	Stop	Stop	Stop	Stop	Stop
RT Channelized	-	-	None	-	-	None	-	-	None	-	-	None
Storage Length	-	-	-	-	-	-	-	-	-	-	-	-
Veh in Median Storage, #	-	0	-	-	0	-	-	0	-	-	0	-
Grade, %	-	0	-	-	0	-	-	0	-	-	0	-
Peak Hour Factor	92	92	92	92	92	92	92	92	92	92	92	92
Heavy Vehicles, %	2	2	2	2	2	2	2	2	2	2	2	2
Mvmt Flow	59	16	45	0	16	0	18	2	0	0	2	41





























Major/Minor	Major1			Major2			Minor1			Minor2		
Conflicting Flow All	16	0	0	61	0	0	195	173	39	174	195	16
Stage 1	-	-	-	-	-	-	157	157	-	16	16	-
Stage 2	-	-	-	-	-	-	38	16	-	158	179	-
Critical Hdwy	4.12	-	-	4.12	-	-	7.12	6.52	6.22	7.12	6.52	6.22
Critical Hdwy Stg 1	-	-	-	-	-	-	6.12	5.52	-	6.12	5.52	-
Critical Hdwy Stg 2	-	-	-	-	-	-	6.12	5.52	-	6.12	5.52	-
Follow-up Hdwy	2.218	-	-	2.218	-	-	3.518	4.018	3.318	3.518	4.018	3.318
Pot Cap-1 Maneuver	1602	-	-	1542	-	-	764	720	1033	789	700	1063
Stage 1	-	-	-	-	-	-	845	768	-	1004	882	-
Stage 2	-	-	-	-	-	-	977	882	-	844	751	-
Platoon blocked, %	-	-	-	-	-	-	-	-	-	-	-	-
Mov Cap-1 Maneuver	1602	-	-	1542	-	-	711	693	1033	765	673	1063
Mov Cap-2 Maneuver	-	-	-	-	-	-	711	693	-	765	673	-
Stage 1	-	-	-	-	-	-	813	739	-	966	882	-
Stage 2	-	-	-	-	-	-	937	882	-	810	722	-

Approach	EB	WB	NB	SB
HCM Control Delay, s	3.6	0	10.2	8.6
HCM LOS			B	A

Minor Lane/Major Mvmt	NBLn1	EBL	EBT	EBR	WBL	WBT	WBR	SBLn1
Capacity (veh/h)	709	1602	-	-	1542	-	-	1033
HCM Lane V/C Ratio	0.029	0.037	-	-	-	-	-	0.042
HCM Control Delay (s)	10.2	7.3	0	-	0	-	-	8.6
HCM Lane LOS	B	A	A	-	A	-	-	A
HCM 95th %tile Q(veh)	0.1	0.1	-	-	0	-	-	0.1

Timings
1: Front Street & Founders Parkway (SH 86)

Background Traffic Volumes
Year 2041 - PM Peak Hour

												
Lane Group	EBL	EBT	EBR	WBL	WBT	WBR	NBL	NBT	NBR	SBL	SBT	SBR
Lane Configurations	 				 		 	  			  	
Traffic Volume (vph)	458	164	253	43	111	128	148	1980	18	235	2492	506
Future Volume (vph)	458	164	253	43	111	128	148	1980	18	235	2492	506
Satd. Flow (prot)	3433	1863	1583	1770	3256	0	3433	5080	0	1770	5085	1583
Flt Permitted	0.282			0.645			0.068			0.063		
Satd. Flow (perm)	1019	1863	1583	1201	3256	0	246	5080	0	117	5085	1583
Satd. Flow (RTOR)			164		139			1				431
Lane Group Flow (vph)	498	178	275	47	260	0	161	2172	0	255	2709	550
Turn Type	pm+pt	NA	Perm	pm+pt	NA		pm+pt	NA		pm+pt	NA	Perm
Protected Phases	7	4		3	8		1	6		5	2	
Permitted Phases	4		4	8			6			2		2
Detector Phase	7	4	4	3	8		1	6		5	2	2
Switch Phase												
Minimum Initial (s)	3.0	5.0	5.0	3.0	5.0		3.0	20.0		3.0	20.0	20.0
Minimum Split (s)	10.0	11.0	11.0	10.0	11.0		10.0	26.0		10.0	26.0	26.0
Total Split (s)	20.0	25.0	25.0	10.0	15.0		10.0	64.0		21.0	75.0	75.0
Total Split (%)	16.7%	20.8%	20.8%	8.3%	12.5%		8.3%	53.3%		17.5%	62.5%	62.5%
Yellow Time (s)	3.0	4.0	4.0	3.0	4.0		3.0	4.0		3.0	4.0	4.0
All-Red Time (s)	2.0	2.0	2.0	2.0	2.0		2.0	2.0		2.0	2.0	2.0
Lost Time Adjust (s)	0.0	0.0	0.0	0.0	0.0		0.0	0.0		0.0	0.0	0.0
Total Lost Time (s)	5.0	6.0	6.0	5.0	6.0		5.0	6.0		5.0	6.0	6.0
Lead/Lag	Lead	Lag	Lag	Lead	Lag		Lead	Lag		Lead	Lag	Lag
Lead-Lag Optimize?	Yes	Yes	Yes	Yes	Yes		Yes	Yes		Yes	Yes	Yes
Recall Mode	None	None	None	None	None		None	C-Max		None	C-Max	C-Max
Act Effct Green (s)	29.2	20.2	20.2	14.2	8.2		65.9	59.5		80.8	69.4	69.4
Actuated g/C Ratio	0.24	0.17	0.17	0.12	0.07		0.55	0.50		0.67	0.58	0.58
v/c Ratio	0.91	0.57	0.68	0.28	0.74		0.58	0.86		0.89	0.92	0.50
Control Delay	62.2	54.5	28.7	40.6	38.4		22.7	31.5		62.1	29.5	4.7
Queue Delay	0.0	0.0	0.0	0.0	0.0		0.0	0.0		0.0	0.0	0.0
Total Delay	62.2	54.5	28.7	40.6	38.4		22.7	31.5		62.1	29.5	4.7
LOS	E	D	C	D	D		C	C		E	C	A
Approach Delay		51.1			38.7			30.9			28.0	
Approach LOS		D			D			C			C	
Queue Length 50th (ft)	175	130	80	28	48		20	540		142	664	40
Queue Length 95th (ft)	#237	207	181	61	94		48	615		#288	749	109
Internal Link Dist (ft)		695			413			423			624	
Turn Bay Length (ft)	285		285	195			175			455		
Base Capacity (vph)	549	315	404	165	372		277	2520		300	2940	1097
Starvation Cap Reductn	0	0	0	0	0		0	0		0	0	0
Spillback Cap Reductn	0	0	0	0	0		0	0		0	0	0
Storage Cap Reductn	0	0	0	0	0		0	0		0	0	0
Reduced v/c Ratio	0.91	0.57	0.68	0.28	0.70		0.58	0.86		0.85	0.92	0.50

Intersection Summary









Cycle Length: 120
 Actuated Cycle Length: 120
 Offset: 112 (93%), Referenced to phase 2:SBTL and 6:NBTL, Start of Green
 Natural Cycle: 90
 Control Type: Actuated-Coordinated

Timings
 1: Front Street & Founders Parkway (SH 86)

Background Traffic Volumes
 Year 2041 - PM Peak Hour

































Maximum v/c Ratio: 0.92
 Intersection Signal Delay: 32.5 Intersection LOS: C
 Intersection Capacity Utilization 91.0% ICU Level of Service E
 Analysis Period (min) 15
 # 95th percentile volume exceeds capacity, queue may be longer.
 Queue shown is maximum after two cycles.

Splits and Phases: 1: Front Street & Founders Parkway (SH 86)

 Ø1	 Ø2 (R)	 Ø3	 Ø4
10 s	75 s	10 s	25 s
 Ø5	 Ø6 (R)	 Ø7	 Ø8
21 s	64 s	20 s	15 s

Timings
2: Allen Way & Founders Parkway (SH 86)

Background Traffic Volumes
Year 2041 - PM Peak Hour

												
Lane Group	EBL	EBT	EBR	WBL	WBT	WBR	NBL	NBT	NBR	SBL	SBT	SBR
Lane Configurations	 	  			  		 	 		 		
Traffic Volume (vph)	539	3108	354	69	2314	185	232	39	51	98	88	608
Future Volume (vph)	539	3108	354	69	2314	185	232	39	51	98	88	608
Satd. Flow (prot)	3433	5085	1583	1770	5085	1583	3433	1704	0	3433	1863	2787
Flt Permitted	0.950			0.068			0.695			0.611		
Satd. Flow (perm)	3433	5085	1583	127	5085	1583	2512	1704	0	2208	1863	2787
Satd. Flow (RTOR)			287			149		43				481
Lane Group Flow (vph)	586	3378	385	75	2515	201	252	97	0	107	96	661
Turn Type	Prot	NA	Perm	pm+pt	NA	Perm	pm+pt	NA		pm+pt	NA	Perm
Protected Phases	5	2		1	6		7	4		3	8	
Permitted Phases			2	6		6	4			8		8
Detector Phase	5	2	2	1	6	6	7	4		3	8	8
Switch Phase												
Minimum Initial (s)	5.0	20.0	20.0	5.0	20.0	20.0	5.0	5.0		5.0	5.0	5.0
Minimum Split (s)	10.0	26.0	26.0	10.0	26.0	26.0	10.0	11.0		11.0	11.0	11.0
Total Split (s)	25.0	83.0	83.0	10.0	68.0	68.0	10.0	16.0		11.0	17.0	17.0
Total Split (%)	20.8%	69.2%	69.2%	8.3%	56.7%	56.7%	8.3%	13.3%		9.2%	14.2%	14.2%
Yellow Time (s)	3.0	4.0	4.0	3.0	4.0	4.0	3.0	4.0		3.0	4.0	4.0
All-Red Time (s)	2.0	2.0	2.0	2.0	2.0	2.0	2.0	2.0		2.0	2.0	2.0
Lost Time Adjust (s)	0.0	0.0	0.0	0.0	0.0	0.0	0.0	0.0		0.0	0.0	0.0
Total Lost Time (s)	5.0	6.0	6.0	5.0	6.0	6.0	5.0	6.0		5.0	6.0	6.0
Lead/Lag	Lead	Lead	Lead	Lag	Lag	Lag	Lead	Lag		Lead	Lag	Lag
Lead-Lag Optimize?	Yes	Yes	Yes	Yes	Yes	Yes	Yes	Yes		Yes	Yes	Yes
Recall Mode	None	C-Min	C-Min	None	C-Min	C-Min	None	None		None	None	None
Act Effct Green (s)	20.3	79.3	79.3	63.0	62.0	62.0	15.7	9.7		17.7	10.7	10.7
Actuated g/C Ratio	0.17	0.66	0.66	0.52	0.52	0.52	0.13	0.08		0.15	0.09	0.09
v/c Ratio	1.01	1.01	0.34	0.56	0.96	0.23	0.68	0.55		0.28	0.58	0.96
Control Delay	64.8	27.3	4.2	51.1	38.2	5.2	56.2	42.9		45.7	68.2	44.5
Queue Delay	0.0	37.2	0.8	0.0	3.4	0.0	0.0	0.0		0.0	0.0	1.4
Total Delay	64.8	64.5	5.0	51.1	41.6	5.2	56.2	42.9		45.7	68.2	45.9
LOS	E	E	A	D	D	A	E	D		D	E	D
Approach Delay		59.3			39.2			52.5			48.3	
Approach LOS		E			D			D			D	
Queue Length 50th (ft)	~252	~1025	50	28	658	19	89	40		38	72	92
Queue Length 95th (ft)	m214	m525	m35	#62	#769	59	130	97		m67	m129	#241
Internal Link Dist (ft)		347			406			277			368	
Turn Bay Length (ft)	300			330			80			120		100
Base Capacity (vph)	579	3358	1142	135	2627	889	368	181		387	170	692
Starvation Cap Reductn	0	732	463	0	0	0	0	0		0	0	0
Spillback Cap Reductn	0	0	0	0	80	0	0	0		0	0	7
Storage Cap Reductn	0	0	0	0	0	0	0	0		0	0	0
Reduced v/c Ratio	1.01	1.29	0.57	0.56	0.99	0.23	0.68	0.54		0.28	0.56	0.96

Intersection Summary

Cycle Length: 120
 Actuated Cycle Length: 120
 Offset: 107 (89%), Referenced to phase 2:EBT and 6:WBTL, Start of Green
 Natural Cycle: 120
 Control Type: Actuated-Coordinated

Timings
 2: Allen Way & Founders Parkway (SH 86)

Background Traffic Volumes
 Year 2041 - PM Peak Hour

Maximum v/c Ratio: 1.01
 Intersection Signal Delay: 51.2 Intersection LOS: D
 Intersection Capacity Utilization 91.7% ICU Level of Service F
 Analysis Period (min) 15
 ~ Volume exceeds capacity, queue is theoretically infinite.
 Queue shown is maximum after two cycles.
 # 95th percentile volume exceeds capacity, queue may be longer.
 Queue shown is maximum after two cycles.
 m Volume for 95th percentile queue is metered by upstream signal.

Splits and Phases: 2: Allen Way & Founders Parkway (SH 86)













→ Ø2 (R) 83 s	↓	↙ Ø1 10 s	↘ Ø3 11 s	↖ Ø4 16 s
↗ Ø5 25 s	↖ Ø6 (R) 68 s	↙ Ø7 10 s	↘ Ø8 17 s	

Timings

Background Traffic Volumes

3: I-25 NB Off-Ramp/I-25 NB On-Ramp & Founders Parkway (SH 86)

Year 2041 - PM Peak Hour

												
Lane Group	EBL	EBT	EBR	WBL	WBT	WBR	NBL	NBT	NBR	SBL	SBT	SBR
Lane Configurations		↑↑↑	↗		↑↑	↗	↘↘		↘↘			
Traffic Volume (vph)	0	3490	834	0	1748	1427	592	0	522	0	0	0
Future Volume (vph)	0	3490	834	0	1748	1427	592	0	522	0	0	0
Satd. Flow (prot)	0	4787	1362	0	3285	1441	3433	0	2787	0	0	0
Flt Permitted							0.950					
Satd. Flow (perm)	0	4787	1362	0	3285	1441	3433	0	2787	0	0	0
Satd. Flow (RTOR)		7	364		64	425			27			
Lane Group Flow (vph)	0	3884	816	0	2396	1055	643	0	567	0	0	0
Turn Type		NA	Free		NA	Free	Prot		Prot			
Protected Phases		2			2		4		4			
Permitted Phases			Free			Free						
Detector Phase		2			2		4		4			
Switch Phase												
Minimum Initial (s)		20.0			20.0		5.0		5.0			
Minimum Split (s)		26.0			26.0		10.5		10.5			
Total Split (s)		92.0			92.0		28.0		28.0			
Total Split (%)		76.7%			76.7%		23.3%		23.3%			
Yellow Time (s)		4.0			4.0		3.5		3.5			
All-Red Time (s)		2.0			2.0		2.0		2.0			
Lost Time Adjust (s)		0.0			0.0		0.0		0.0			
Total Lost Time (s)		6.0			6.0		5.5		5.5			
Lead/Lag												
Lead-Lag Optimize?												
Recall Mode		C-Max			C-Max		None		None			
Act Effct Green (s)		86.0	120.0		86.0	120.0	22.5		22.5			
Actuated g/C Ratio		0.72	1.00		0.72	1.00	0.19		0.19			
v/c Ratio		1.13	0.60		1.01	0.73	1.00		1.04			
Control Delay		82.9	2.0		24.2	7.4	84.4		95.2			
Queue Delay		0.1	0.0		35.0	0.0	0.0		37.2			
Total Delay		83.0	2.0		59.2	7.4	84.4		132.4			
LOS		F	A		E	A	F		F			
Approach Delay		68.9			43.3			106.9				
Approach LOS		E			D			F				
Queue Length 50th (ft)		~1358	0		~265	757	259		~259			
Queue Length 95th (ft)		#1432	0		m#1195	m815	#384		#387			
Internal Link Dist (ft)		649			347			213			215	
Turn Bay Length (ft)			500						100			
Base Capacity (vph)		3432	1362		2372	1441	643		544			
Starvation Cap Reductn		0	0		269	0	0		0			
Spillback Cap Reductn		253	0		0	0	0		394			
Storage Cap Reductn		0	0		0	0	0		0			
Reduced v/c Ratio		1.22	0.60		1.14	0.73	1.00		3.78			
Intersection Summary												
Cycle Length: 120												
Actuated Cycle Length: 120												
Offset: 106 (88%), Referenced to phase 2:EBWB, Start of Green												
Natural Cycle: 150												
Control Type: Actuated-Coordinated												

Timings

Background Traffic Volumes

3: I-25 NB Off-Ramp/I-25 NB On-Ramp & Founders Parkway (SH 86)

Year 2041 - PM Peak Hour

Maximum v/c Ratio: 1.13

Intersection Signal Delay: 64.4

Intersection LOS: E

Intersection Capacity Utilization 101.5%

ICU Level of Service G

Analysis Period (min) 15

~ Volume exceeds capacity, queue is theoretically infinite.

Queue shown is maximum after two cycles.

95th percentile volume exceeds capacity, queue may be longer.

Queue shown is maximum after two cycles.

m Volume for 95th percentile queue is metered by upstream signal.

Splits and Phases: 3: I-25 NB Off-Ramp/I-25 NB On-Ramp & Founders Parkway (SH 86)

 <p>02 (R)</p> <p>92 s</p>	 <p>04</p> <p>28 s</p>
---	---

Timings
4: Allen Way & Allen Street

Background Traffic Volumes
Year 2041 - PM Peak Hour

Lane Group	EBL	EBT	EBR	WBL	WBT	WBR	NBL	NBT	NBR	SBL	SBT	SBR
Lane Configurations												
Traffic Volume (vph)	2	86	125	222	34	62	214	463	117	22	507	14
Future Volume (vph)	2	86	125	222	34	62	214	463	117	22	507	14
Satd. Flow (prot)	1770	1697	0	1770	1863	1583	1770	3539	1583	0	3518	0
Flt Permitted	0.578			0.616			0.394				0.925	
Satd. Flow (perm)	1077	1697	0	1147	1863	1583	734	3539	1583	0	3261	0
Satd. Flow (RTOR)		132				218			218		6	
Lane Group Flow (vph)	2	229	0	241	37	67	233	503	127	0	590	0
Turn Type	pm+pt	NA		Perm	NA	Perm	Perm	NA	Perm	D.P+P	NA	
Protected Phases	3	8			4			6		5	2	
Permitted Phases	8			4		4	6		6	6		
Detector Phase	3	8		4	4	4	6	6	6	5	2	
Switch Phase												
Minimum Initial (s)	3.0	5.0		5.0	5.0	5.0	5.0	5.0	5.0	3.0	5.0	
Minimum Split (s)	8.0	10.0		10.0	10.0	10.0	10.0	10.0	10.0	8.0	10.0	
Total Split (s)	8.0	25.0		17.0	17.0	17.0	27.0	27.0	27.0	8.0	35.0	
Total Split (%)	13.3%	41.7%		28.3%	28.3%	28.3%	45.0%	45.0%	45.0%	13.3%	58.3%	
Yellow Time (s)	3.0	3.0		3.0	3.0	3.0	3.0	3.0	3.0	3.0	3.0	
All-Red Time (s)	2.0	2.0		2.0	2.0	2.0	2.0	2.0	2.0	2.0	2.0	
Lost Time Adjust (s)	0.0	0.0		0.0	0.0	0.0	0.0	0.0	0.0		0.0	
Total Lost Time (s)	5.0	5.0		5.0	5.0	5.0	5.0	5.0	5.0		5.0	
Lead/Lag	Lead			Lag	Lag	Lag	Lag	Lag	Lag	Lead		
Lead-Lag Optimize?	Yes			Yes	Yes	Yes	Yes	Yes	Yes	Yes		
Recall Mode	None	None		None	None	None	C-Min	C-Min	C-Min	None	C-Min	
Act Effct Green (s)	20.2	20.2		18.6	18.6	18.6	29.8	29.8	29.8		29.8	
Actuated g/C Ratio	0.34	0.34		0.31	0.31	0.31	0.50	0.50	0.50		0.50	
v/c Ratio	0.00	0.35		0.68	0.06	0.10	0.64	0.29	0.14		0.36	
Control Delay	13.5	8.5		34.1	16.9	0.3	22.8	5.6	0.3		9.9	
Queue Delay	0.0	0.0		0.0	0.0	0.0	0.0	0.0	0.0		0.0	
Total Delay	13.5	8.5		34.1	16.9	0.3	22.8	5.6	0.3		9.9	
LOS	B	A		C	B	A	C	A	A		A	
Approach Delay		8.6			25.7			9.5			9.9	
Approach LOS		A			C			A			A	
Queue Length 50th (ft)	1	24		72	9	0	66	28	0		62	
Queue Length 95th (ft)	4	69		#218	32	0	m92	m36	m0		93	
Internal Link Dist (ft)		422			420			368			300	
Turn Bay Length (ft)	60			95		65	70		95			
Base Capacity (vph)	408	658		355	577	640	365	1758	896		1633	
Starvation Cap Reductn	0	0		0	0	0	0	0	0		0	
Spillback Cap Reductn	0	0		0	0	0	0	0	0		0	
Storage Cap Reductn	0	0		0	0	0	0	0	0		0	
Reduced v/c Ratio	0.00	0.35		0.68	0.06	0.10	0.64	0.29	0.14		0.36	

Intersection Summary

Cycle Length: 60
 Actuated Cycle Length: 60
 Offset: 31 (52%), Referenced to phase 2:SBT and 6:NBSB, Start of Green
 Natural Cycle: 70
 Control Type: Actuated-Coordinated

Timings
4: Allen Way & Allen Street

Background Traffic Volumes
Year 2041 - PM Peak Hour

Maximum v/c Ratio: 0.68

Intersection Signal Delay: 12.3

Intersection LOS: B

Intersection Capacity Utilization 69.1%

ICU Level of Service C







Analysis Period (min) 15

95th percentile volume exceeds capacity, queue may be longer.

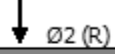
Queue shown is maximum after two cycles.

m Volume for 95th percentile queue is metered by upstream signal.

Splits and Phases: 4: Allen Way & Allen Street

					
35 s		8 s		17 s	
					
8 s		27 s		25 s	

HCM 6th TWSC
5: Allen Street & Alexander Place

Background Traffic Volumes
Year 2041 - PM Peak Hour

Intersection												
Int Delay, s/veh	10											
Movement	EBL	EBT	EBR	WBL	WBT	WBR	NBL	NBT	NBR	SBL	SBT	SBR
Lane Configurations		↕		↕	↕		↕	↑	↕	↕	↕	
Traffic Vol, veh/h	84	16	75	127	10	86	82	151	133	56	145	24
Future Vol, veh/h	84	16	75	127	10	86	82	151	133	56	145	24
Conflicting Peds, #/hr	0	0	0	0	0	0	0	0	0	0	0	0
Sign Control	Stop	Stop	Stop	Stop	Stop	Stop	Free	Free	Free	Free	Free	Free
RT Channelized	-	-	None	-	-	None	-	-	None	-	-	None
Storage Length	-	-	-	60	-	-	75	-	75	80	-	-
Veh in Median Storage, #	-	0	-	-	0	-	-	0	-	-	0	-
Grade, %	-	0	-	-	0	-	-	0	-	-	0	-
Peak Hour Factor	92	92	92	92	92	92	92	92	92	92	92	92
Heavy Vehicles, %	2	2	2	2	2	2	2	2	2	2	2	2
Mvmt Flow	91	17	82	138	11	93	89	164	145	61	158	26

Major/Minor	Minor2		Minor1		Major1		Major2					
Conflicting Flow All	760	780	171	685	648	164	184	0	0	309	0	0
Stage 1	293	293	-	342	342	-	-	-	-	-	-	-
Stage 2	467	487	-	343	306	-	-	-	-	-	-	-
Critical Hdwy	7.12	6.52	6.22	7.12	6.52	6.22	4.12	-	-	4.12	-	-
Critical Hdwy Stg 1	6.12	5.52	-	6.12	5.52	-	-	-	-	-	-	-
Critical Hdwy Stg 2	6.12	5.52	-	6.12	5.52	-	-	-	-	-	-	-
Follow-up Hdwy	3.518	4.018	3.318	3.518	4.018	3.318	2.218	-	-	2.218	-	-
Pot Cap-1 Maneuver	323	327	873	362	389	881	1391	-	-	1252	-	-
Stage 1	715	670	-	673	638	-	-	-	-	-	-	-
Stage 2	576	550	-	672	662	-	-	-	-	-	-	-
Platoon blocked, %								-	-	-	-	-
Mov Cap-1 Maneuver	258	291	873	287	346	881	1391	-	-	1252	-	-
Mov Cap-2 Maneuver	258	291	-	287	346	-	-	-	-	-	-	-
Stage 1	669	637	-	630	597	-	-	-	-	-	-	-
Stage 2	473	515	-	564	630	-	-	-	-	-	-	-

Approach	EB		WB		NB		SB	
HCM Control Delay, s	24.1		20.8		1.7		2	
HCM LOS	C		C					

Minor Lane/Major Mvmt	NBL	NBT	NBR	EBLn1	WBLn1	WBLn2	SBL	SBT	SBR
Capacity (veh/h)	1391	-	-	375	287	759	1252	-	-
HCM Lane V/C Ratio	0.064	-	-	0.507	0.481	0.137	0.049	-	-
HCM Control Delay (s)	7.8	-	-	24.1	28.6	10.5	8	-	-
HCM Lane LOS	A	-	-	C	D	B	A	-	-
HCM 95th %tile Q(veh)	0.2	-	-	2.8	2.5	0.5	0.2	-	-

HCM 6th AWSC
6: Allen Street & Front Street

Background Traffic Volumes
Year 2041 - PM Peak Hour

Intersection	
Intersection Delay, s/veh	13.7
Intersection LOS	B

Movement	EBL	EBR	NBL	NBT	SBT	SBR
Lane Configurations	↙	↗	↙	↗	↗	↗
Traffic Vol, veh/h	241	185	115	216	215	162
Future Vol, veh/h	241	185	115	216	215	162
Peak Hour Factor	0.92	0.92	0.92	0.92	0.92	0.92
Heavy Vehicles, %	2	2	2	2	2	2
Mvmt Flow	262	201	125	235	234	176
Number of Lanes	1	1	1	1	1	1

Approach	EB	NB	SB
Opposing Approach		SB	NB
Opposing Lanes	0	2	2
Conflicting Approach Left	SB	EB	
Conflicting Lanes Left	2	2	0
Conflicting Approach Right	NB		EB
Conflicting Lanes Right	2	0	2
HCM Control Delay	14.8	13.5	12.7
HCM LOS	B	B	B

Lane	NBLn1	NBLn2	EBLn1	EBLn2	SBLn1	SBLn2
Vol Left, %	100%	0%	100%	0%	0%	0%
Vol Thru, %	0%	100%	0%	0%	100%	0%
Vol Right, %	0%	0%	0%	100%	0%	100%
Sign Control	Stop	Stop	Stop	Stop	Stop	Stop
Traffic Vol by Lane	115	216	241	185	215	162
LT Vol	115	0	241	0	0	0
Through Vol	0	216	0	0	215	0
RT Vol	0	0	0	185	0	162
Lane Flow Rate	125	235	262	201	234	176
Geometry Grp	7	7	7	7	7	7
Degree of Util (X)	0.246	0.429	0.518	0.33	0.425	0.286
Departure Headway (Hd)	7.091	6.581	7.116	5.9	6.552	5.838
Convergence, Y/N	Yes	Yes	Yes	Yes	Yes	Yes
Cap	505	545	506	607	547	613
Service Time	4.857	4.346	4.871	3.655	4.316	3.602
HCM Lane V/C Ratio	0.248	0.431	0.518	0.331	0.428	0.287
HCM Control Delay	12.2	14.2	17.3	11.6	14.1	10.9
HCM Lane LOS	B	B	C	B	B	B
HCM 95th-tile Q	1	2.1	2.9	1.4	2.1	1.2

HCM 6th TWSC
7: Private Access/Brewer Court & Alexander Place

Background Traffic Volumes
Year 2041 - PM Peak Hour

Intersection												
Int Delay, s/veh	8											
Movement	EBL	EBT	EBR	WBL	WBT	WBR	NBL	NBT	NBR	SBL	SBT	SBR
Lane Configurations	↕			↕			↕			↕		
Traffic Vol, veh/h	161	21	9	0	25	0	29	2	0	0	2	183
Future Vol, veh/h	161	21	9	0	25	0	29	2	0	0	2	183
Conflicting Peds, #/hr	0	0	0	0	0	0	0	0	0	0	0	0
Sign Control	Free	Free	Free	Free	Free	Free	Stop	Stop	Stop	Stop	Stop	Stop
RT Channelized	-	-	None	-	-	None	-	-	None	-	-	None
Storage Length	-	-	-	-	-	-	-	-	-	-	-	-
Veh in Median Storage, #	-	0	-	-	0	-	-	0	-	-	0	-
Grade, %	-	0	-	-	0	-	-	0	-	-	0	-
Peak Hour Factor	92	92	92	92	92	92	92	92	92	92	92	92
Heavy Vehicles, %	2	2	2	2	2	2	2	2	2	2	2	2
Mvmt Flow	175	23	10	0	27	0	32	2	0	0	2	199































Major/Minor	Major1			Major2			Minor1			Minor2		
Conflicting Flow All	27	0	0	33	0	0	506	405	28	406	410	27
Stage 1	-	-	-	-	-	-	378	378	-	27	27	-
Stage 2	-	-	-	-	-	-	128	27	-	379	383	-
Critical Hdwy	4.12	-	-	4.12	-	-	7.12	6.52	6.22	7.12	6.52	6.22
Critical Hdwy Stg 1	-	-	-	-	-	-	6.12	5.52	-	6.12	5.52	-
Critical Hdwy Stg 2	-	-	-	-	-	-	6.12	5.52	-	6.12	5.52	-
Follow-up Hdwy	2.218	-	-	2.218	-	-	3.518	4.018	3.318	3.518	4.018	3.318
Pot Cap-1 Maneuver	1587	-	-	1579	-	-	477	535	1047	555	531	1048
Stage 1	-	-	-	-	-	-	644	615	-	990	873	-
Stage 2	-	-	-	-	-	-	876	873	-	643	612	-
Platoon blocked, %	-	-	-	-	-	-	-	-	-	-	-	-
Mov Cap-1 Maneuver	1587	-	-	1579	-	-	352	475	1047	506	472	1048
Mov Cap-2 Maneuver	-	-	-	-	-	-	352	475	-	506	472	-
Stage 1	-	-	-	-	-	-	572	546	-	879	873	-
Stage 2	-	-	-	-	-	-	708	873	-	569	543	-

Approach	EB			WB			NB			SB		
HCM Control Delay, s	6.4			0			16.1			9.3		
HCM LOS							C			A		

Minor Lane/Major Mvmt	NBLn1	EBL	EBT	EBR	WBL	WBT	WBR	SBLn1
Capacity (veh/h)	358	1587	-	-	1579	-	-	1034
HCM Lane V/C Ratio	0.094	0.11	-	-	-	-	-	0.194
HCM Control Delay (s)	16.1	7.5	0	-	0	-	-	9.3
HCM Lane LOS	C	A	A	-	A	-	-	A
HCM 95th %tile Q(veh)	0.3	0.4	-	-	0	-	-	0.7

Timings
1: Front Street & Founders Parkway (SH 86)

Background Traffic Volumes
Year 2041 - Saturday Peak Hour

												
Lane Group	EBL	EBT	EBR	WBL	WBT	WBR	NBL	NBT	NBR	SBL	SBT	SBR
Lane Configurations	 		 		 		 	 		 	  	 
Traffic Volume (vph)	497	154	207	65	169	133	162	2219	55	228	2026	562
Future Volume (vph)	497	154	207	65	169	133	162	2219	55	228	2026	562
Satd. Flow (prot)	3433	1863	1583	1770	3306	0	3433	5065	0	1770	5085	1583
Flt Permitted	0.308			0.651			0.085			0.077		
Satd. Flow (perm)	1113	1863	1583	1213	3306	0	307	5065	0	143	5085	1583
Satd. Flow (RTOR)			196		109			5				437
Lane Group Flow (vph)	540	167	225	71	329	0	176	2472	0	248	2202	611
Turn Type	pm+pt	NA	Perm	pm+pt	NA		pm+pt	NA		pm+pt	NA	Perm
Protected Phases	7	4		3	8		1	6		5	2	
Permitted Phases	4		4	8			6			2		2
Detector Phase	7	4	4	3	8		1	6		5	2	2
Switch Phase												
Minimum Initial (s)	3.0	5.0	5.0	3.0	5.0		3.0	20.0		3.0	20.0	20.0
Minimum Split (s)	10.0	11.0	11.0	10.0	11.0		10.0	26.0		10.0	26.0	26.0
Total Split (s)	17.0	20.0	20.0	10.0	13.0		10.0	54.0		16.0	60.0	60.0
Total Split (%)	17.0%	20.0%	20.0%	10.0%	13.0%		10.0%	54.0%		16.0%	60.0%	60.0%
Yellow Time (s)	3.0	4.0	4.0	3.0	4.0		3.0	4.0		3.0	4.0	4.0
All-Red Time (s)	2.0	2.0	2.0	2.0	2.0		2.0	2.0		2.0	2.0	2.0
Lost Time Adjust (s)	0.0	0.0	0.0	0.0	0.0		0.0	0.0		0.0	0.0	0.0
Total Lost Time (s)	5.0	6.0	6.0	5.0	6.0		5.0	6.0		5.0	6.0	6.0
Lead/Lag	Lead	Lag	Lag	Lead	Lag		Lead	Lag		Lead	Lag	Lag
Lead-Lag Optimize?	Yes	Yes	Yes	Yes	Yes		Yes	Yes		Yes	Yes	Yes
Recall Mode	None	None	None	None	None		None	C-Max		None	C-Max	C-Max
Act Effct Green (s)	25.0	16.0	16.0	13.0	7.0		54.0	48.0		65.0	54.0	54.0
Actuated g/C Ratio	0.25	0.16	0.16	0.13	0.07		0.54	0.48		0.65	0.54	0.54
v/c Ratio	0.97	0.56	0.54	0.38	0.99		0.55	1.02		0.92	0.80	0.58
Control Delay	67.3	48.2	13.8	37.3	79.6		16.3	48.9		61.6	21.6	6.4
Queue Delay	0.0	0.0	0.0	0.0	0.0		0.0	0.0		0.0	0.0	0.0
Total Delay	67.3	48.2	13.8	37.3	79.6		16.3	48.9		61.6	21.6	6.4
LOS	E	D	B	D	E		B	D		E	C	A
Approach Delay		50.9			72.1			46.8			21.8	
Approach LOS		D			E			D			C	
Queue Length 50th (ft)	158	102	16	36	75		19	~583		104	395	54
Queue Length 95th (ft)	#233	#176	88	72	#168		36	#710		#252	462	145
Internal Link Dist (ft)		695			413			423			624	
Turn Bay Length (ft)	285		285	195			175			455		
Base Capacity (vph)	556	297	418	185	332		322	2433		271	2745	1055
Starvation Cap Reductn	0	0	0	0	0		0	0		0	0	0
Spillback Cap Reductn	0	0	0	0	0		0	0		0	0	0
Storage Cap Reductn	0	0	0	0	0		0	0		0	0	0
Reduced v/c Ratio	0.97	0.56	0.54	0.38	0.99		0.55	1.02		0.92	0.80	0.58

Intersection Summary

Cycle Length: 100
 Actuated Cycle Length: 100
 Offset: 62 (62%), Referenced to phase 2:SBTL and 6:NBTL, Start of Green
 Natural Cycle: 90
 Control Type: Actuated-Coordinated

Timings
 1: Front Street & Founders Parkway (SH 86)

Background Traffic Volumes
 Year 2041 - Saturday Peak Hour





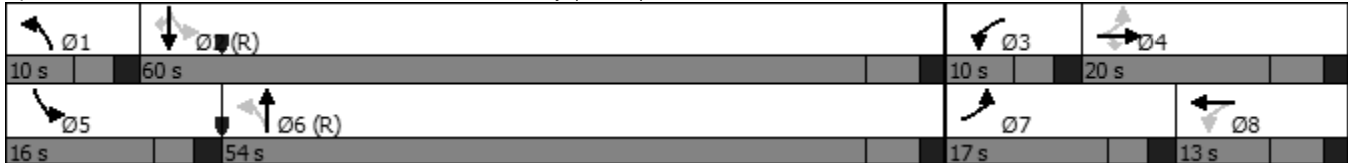



























Maximum v/c Ratio: 1.02	
Intersection Signal Delay: 37.9	Intersection LOS: D
Intersection Capacity Utilization 98.2%	ICU Level of Service F
Analysis Period (min) 15	
~ Volume exceeds capacity, queue is theoretically infinite. Queue shown is maximum after two cycles.	
# 95th percentile volume exceeds capacity, queue may be longer. Queue shown is maximum after two cycles.	

Splits and Phases: 1: Front Street & Founders Parkway (SH 86)



Timings
2: Allen Way & Founders Parkway (SH 86)

Background Traffic Volumes
Year 2041 - Saturday Peak Hour

												
Lane Group	EBL	EBT	EBR	WBL	WBT	WBR	NBL	NBT	NBR	SBL	SBT	SBR
Lane Configurations	 	  			  		 			 		 
Traffic Volume (vph)	674	2491	323	64	2482	289	269	52	128	200	55	732
Future Volume (vph)	674	2491	323	64	2482	289	269	52	128	200	55	732
Satd. Flow (prot)	3433	5085	1583	1770	5085	1583	3433	1665	0	3433	1863	2787
Flt Permitted	0.950			0.087			0.718			0.571		
Satd. Flow (perm)	3433	5085	1583	162	5085	1583	2595	1665	0	2063	1863	2787
Satd. Flow (RTOR)			351			247		75				506
Lane Group Flow (vph)	733	2708	351	70	2698	314	292	196	0	217	60	796
Turn Type	Prot	NA	Perm	pm+pt	NA	Perm	pm+pt	NA		pm+pt	NA	Perm
Protected Phases	5	2		1	6		7	4		3	8	
Permitted Phases			2	6		6	4			8		8
Detector Phase	5	2	2	1	6	6	7	4		3	8	8
Switch Phase												
Minimum Initial (s)	5.0	20.0	20.0	5.0	20.0	20.0	5.0	5.0		5.0	5.0	5.0
Minimum Split (s)	10.0	26.0	26.0	10.0	26.0	26.0	10.0	11.0		11.0	11.0	11.0
Total Split (s)	22.0	67.0	67.0	10.0	55.0	55.0	10.0	12.0		11.0	13.0	13.0
Total Split (%)	22.0%	67.0%	67.0%	10.0%	55.0%	55.0%	10.0%	12.0%		11.0%	13.0%	13.0%
Yellow Time (s)	3.0	4.0	4.0	3.0	4.0	4.0	3.0	4.0		3.0	4.0	4.0
All-Red Time (s)	2.0	2.0	2.0	2.0	2.0	2.0	2.0	2.0		2.0	2.0	2.0
Lost Time Adjust (s)	0.0	0.0	0.0	0.0	0.0	0.0	0.0	0.0		0.0	0.0	0.0
Total Lost Time (s)	5.0	6.0	6.0	5.0	6.0	6.0	5.0	6.0		5.0	6.0	6.0
Lead/Lag	Lead	Lead	Lead	Lag	Lag	Lag	Lead	Lag		Lead	Lag	Lag
Lead-Lag Optimize?	Yes	Yes	Yes	Yes	Yes	Yes	Yes	Yes		Yes	Yes	Yes
Recall Mode	None	C-Min	C-Min	None	C-Min	C-Min	None	None		None	None	None
Act Effct Green (s)	17.0	63.0	63.0	50.0	49.0	49.0	12.0	6.0		14.0	7.0	7.0
Actuated g/C Ratio	0.17	0.63	0.63	0.50	0.49	0.49	0.12	0.06		0.14	0.07	0.07
v/c Ratio	1.26	0.85	0.31	0.43	1.08	0.35	0.83	1.15		0.58	0.46	1.20
Control Delay	152.7	19.0	2.8	35.5	71.3	4.8	59.6	143.9		43.5	56.7	119.0
Queue Delay	0.0	46.5	0.4	0.0	7.7	0.0	0.0	0.0		0.0	0.0	0.5
Total Delay	152.7	65.5	3.3	35.5	79.0	4.8	59.6	143.9		43.5	56.7	119.5
LOS	F	E	A	D	E	A	E	F		D	E	F
Approach Delay		76.6			70.5			93.4			100.6	
Approach LOS		E			E			F			F	
Queue Length 50th (ft)	~310	501	20	22	~709	22	87	~100		62	38	~167
Queue Length 95th (ft)	m#307	m497	m20	46	#803	69	#151	#243		97	79	#300
Internal Link Dist (ft)		347			406			277			368	
Turn Bay Length (ft)	300			330			80			120		100
Base Capacity (vph)	583	3203	1127	163	2491	901	353	170		371	130	665
Starvation Cap Reductn	0	862	385	0	0	0	0	0		0	0	0
Spillback Cap Reductn	0	0	0	0	453	0	0	0		0	0	45
Storage Cap Reductn	0	0	0	0	0	0	0	0		0	0	0
Reduced v/c Ratio	1.26	1.16	0.47	0.43	1.32	0.35	0.83	1.15		0.58	0.46	1.28

Intersection Summary

Cycle Length: 100
 Actuated Cycle Length: 100
 Offset: 70 (70%), Referenced to phase 2:EBT and 6:WBTL, Start of Green
 Natural Cycle: 140
 Control Type: Actuated-Coordinated

Timings
 2: Allen Way & Founders Parkway (SH 86)

Background Traffic Volumes
 Year 2041 - Saturday Peak Hour

Maximum v/c Ratio: 1.26
 Intersection Signal Delay: 78.4 Intersection LOS: E
 Intersection Capacity Utilization 101.8% ICU Level of Service G
 Analysis Period (min) 15
 ~ Volume exceeds capacity, queue is theoretically infinite.
 Queue shown is maximum after two cycles.
 # 95th percentile volume exceeds capacity, queue may be longer.
 Queue shown is maximum after two cycles.
 m Volume for 95th percentile queue is metered by upstream signal.













Splits and Phases: 2: Allen Way & Founders Parkway (SH 86)

→ Ø2 (R) 67 s	↓	↙ Ø1 10 s	↘ Ø3 11 s	↑ Ø4 12 s
↗ Ø5 22 s	↖ Ø6 (R) 55 s	↙ Ø7 10 s	↓ Ø8 13 s	

Timings

Background Traffic Volumes

3: I-25 NB Off-Ramp/I-25 NB On-Ramp & Founders Parkway (SH 86) Year 2041 - Saturday Peak Hour

												
Lane Group	EBL	EBT	EBR	WBL	WBT	WBR	NBL	NBT	NBR	SBL	SBT	SBR
Lane Configurations		↑↑↑	↗		↑↑	↗	↘↘		↘↘			
Traffic Volume (vph)	0	2924	738	0	1981	1512	760	0	568	0	0	0
Future Volume (vph)	0	2924	738	0	1981	1512	760	0	568	0	0	0
Satd. Flow (prot)	0	4787	1362	0	3295	1441	3433	0	2787	0	0	0
Flt Permitted							0.950					
Satd. Flow (perm)	0	4787	1362	0	3295	1441	3433	0	2787	0	0	0
Satd. Flow (RTOR)		8	461		58	474			33			
Lane Group Flow (vph)	0	3258	722	0	2646	1150	826	0	617	0	0	0
Turn Type		NA	Free		NA	Free	Prot		Prot			
Protected Phases		2			2		4		4			
Permitted Phases			Free			Free						
Detector Phase		2			2		4		4			
Switch Phase												
Minimum Initial (s)		20.0			20.0		5.0		5.0			
Minimum Split (s)		26.0			26.0		10.5		10.5			
Total Split (s)		74.0			74.0		26.0		26.0			
Total Split (%)		74.0%			74.0%		26.0%		26.0%			
Yellow Time (s)		4.0			4.0		3.5		3.5			
All-Red Time (s)		2.0			2.0		2.0		2.0			
Lost Time Adjust (s)		0.0			0.0		0.0		0.0			
Total Lost Time (s)		6.0			6.0		5.5		5.5			
Lead/Lag												
Lead-Lag Optimize?												
Recall Mode		C-Max			C-Max		None		None			
Act Effct Green (s)		68.0	100.0		68.0	100.0	20.5		20.5			
Actuated g/C Ratio		0.68	1.00		0.68	1.00	0.20		0.20			
v/c Ratio		1.00	0.53		1.17	0.80	1.17		1.03			
Control Delay		32.5	1.5		91.9	8.5	129.9		83.7			
Queue Delay		32.9	0.0		0.5	0.0	0.0		29.8			
Total Delay		65.5	1.5		92.4	8.5	129.9		113.5			
LOS		E	A		F	A	F		F			
Approach Delay		53.9			67.0				122.9			
Approach LOS		D			E				F			
Queue Length 50th (ft)		~713	0		~1090	541	~326		~231			
Queue Length 95th (ft)		#937	0		m#930	m435	#444		#353			
Internal Link Dist (ft)		649			347				213			215
Turn Bay Length (ft)			500									100
Base Capacity (vph)		3257	1362		2259	1441	703		597			
Starvation Cap Reductn		0	0		375	0	0		0			
Spillback Cap Reductn		262	0		0	0	0		280			
Storage Cap Reductn		0	0		0	0	0		0			
Reduced v/c Ratio		1.09	0.53		1.40	0.80	1.17		1.95			
Intersection Summary												
Cycle Length: 100												
Actuated Cycle Length: 100												
Offset: 80 (80%), Referenced to phase 2:EBWB, Start of Green												
Natural Cycle: 150												
Control Type: Actuated-Coordinated												

Timings

Background Traffic Volumes

3: I-25 NB Off-Ramp/I-25 NB On-Ramp & Founders Parkway (SH 86) Year 2041 - Saturday Peak Hour

Maximum v/c Ratio: 1.17

Intersection Signal Delay: 70.1

Intersection LOS: E

Intersection Capacity Utilization 100.9%

ICU Level of Service G

Analysis Period (min) 15

~ Volume exceeds capacity, queue is theoretically infinite.

Queue shown is maximum after two cycles.

95th percentile volume exceeds capacity, queue may be longer.

Queue shown is maximum after two cycles.























m Volume for 95th percentile queue is metered by upstream signal.

Splits and Phases: 3: I-25 NB Off-Ramp/I-25 NB On-Ramp & Founders Parkway (SH 86)

 <p>02 (R)</p> <p>74 s</p>	 <p>04</p> <p>26 s</p>
---	---

Timings
4: Allen Way & Allen Street

Background Traffic Volumes
Year 2041 - Saturday Peak Hour

												
Lane Group	EBL	EBT	EBR	WBL	WBT	WBR	NBL	NBT	NBR	SBL	SBT	SBR
Lane Configurations												
Traffic Volume (vph)	14	77	198	195	79	99	226	559	115	80	518	5
Future Volume (vph)	14	77	198	195	79	99	226	559	115	80	518	5
Satd. Flow (prot)	1770	1662	0	1770	1863	1583	1770	3539	1583	0	3511	0
Flt Permitted	0.549			0.578			0.358				0.797	
Satd. Flow (perm)	1023	1662	0	1077	1863	1583	667	3539	1583	0	2818	0
Satd. Flow (RTOR)		215					218		218		2	
Lane Group Flow (vph)	15	299	0	212	86	108	246	608	125	0	655	0
Turn Type	pm+pt	NA		Perm	NA	Perm	Perm	NA	Perm	D.P+P	NA	
Protected Phases	3	8			4			6		5	2	
Permitted Phases	8			4		4	6		6	6		
Detector Phase	3	8		4	4	4	6	6	6	5	2	
Switch Phase												
Minimum Initial (s)	3.0	5.0		5.0	5.0	5.0	5.0	5.0	5.0	3.0	5.0	
Minimum Split (s)	8.0	10.0		10.0	10.0	10.0	10.0	10.0	10.0	8.0	10.0	
Total Split (s)	8.0	24.0		16.0	16.0	16.0	28.0	28.0	28.0	8.0	36.0	
Total Split (%)	13.3%	40.0%		26.7%	26.7%	26.7%	46.7%	46.7%	46.7%	13.3%	60.0%	
Yellow Time (s)	3.0	3.0		3.0	3.0	3.0	3.0	3.0	3.0	3.0	3.0	
All-Red Time (s)	2.0	2.0		2.0	2.0	2.0	2.0	2.0	2.0	2.0	2.0	
Lost Time Adjust (s)	0.0	0.0		0.0	0.0	0.0	0.0	0.0	0.0		0.0	
Total Lost Time (s)	5.0	5.0		5.0	5.0	5.0	5.0	5.0	5.0		5.0	
Lead/Lag	Lead			Lag	Lag	Lag	Lag	Lag	Lag	Lead		
Lead-Lag Optimize?	Yes			Yes	Yes	Yes	Yes	Yes	Yes	Yes		
Recall Mode	None	None		None	None	None	C-Min	C-Min	C-Min	None	C-Min	
Act Effct Green (s)	19.6	19.6		18.0	18.0	18.0	30.4	30.4	30.4		30.4	
Actuated g/C Ratio	0.33	0.33		0.30	0.30	0.30	0.51	0.51	0.51		0.51	
v/c Ratio	0.04	0.43		0.66	0.15	0.17	0.73	0.34	0.14		0.46	
Control Delay	14.5	7.5		34.9	18.2	0.6	27.6	9.4	0.5		10.7	
Queue Delay	0.0	0.0		0.0	0.0	0.0	0.0	0.0	0.0		0.0	
Total Delay	14.5	7.5		34.9	18.2	0.6	27.6	9.4	0.5		10.7	
LOS	B	A		C	B	A	C	A	A		B	
Approach Delay		7.8			22.2			12.8			10.7	
Approach LOS		A			C			B			B	
Queue Length 50th (ft)	4	22		64	22	0	62	62	0		71	
Queue Length 95th (ft)	15	73		#202	61	0	#178	91	4		107	
Internal Link Dist (ft)		422			420			368			300	
Turn Bay Length (ft)	60			95		65	70		95			
Base Capacity (vph)	384	688		323	559	628	337	1791	909		1456	
Starvation Cap Reductn	0	0		0	0	0	0	0	0		0	
Spillback Cap Reductn	0	0		0	0	0	0	0	0		0	
Storage Cap Reductn	0	0		0	0	0	0	0	0		0	
Reduced v/c Ratio	0.04	0.43		0.66	0.15	0.17	0.73	0.34	0.14		0.45	

Intersection Summary

Cycle Length: 60
 Actuated Cycle Length: 60
 Offset: 31 (52%), Referenced to phase 2:SBT and 6:NBSB, Start of Green
 Natural Cycle: 75
 Control Type: Actuated-Coordinated

Timings
 4: Allen Way & Allen Street

Background Traffic Volumes
 Year 2041 - Saturday Peak Hour

Maximum v/c Ratio: 0.73
 Intersection Signal Delay: 13.2 Intersection LOS: B
 Intersection Capacity Utilization 75.9% ICU Level of Service D
 Analysis Period (min) 15
 # 95th percentile volume exceeds capacity, queue may be longer.
 Queue shown is maximum after two cycles.

Splits and Phases: 4: Allen Way & Allen Street

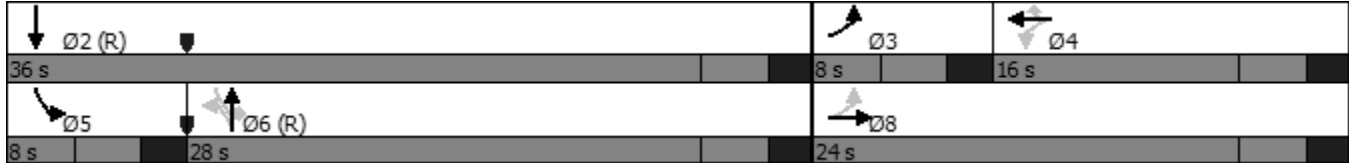

HCM 6th TWSC
5: Allen Street & Alexander Place

Background Traffic Volumes
Year 2041 - Saturday Peak Hour

Intersection												
Int Delay, s/veh	17.6											
Movement	EBL	EBT	EBR	WBL	WBT	WBR	NBL	NBT	NBR	SBL	SBT	SBR
Lane Configurations		↔		↵	↶		↵	↶	↷	↵	↶	
Traffic Vol, veh/h	110	4	70	186	9	60	82	194	149	63	192	38
Future Vol, veh/h	110	4	70	186	9	60	82	194	149	63	192	38
Conflicting Peds, #/hr	0	0	0	0	0	0	0	0	0	0	0	0
Sign Control	Stop	Stop	Stop	Stop	Stop	Stop	Free	Free	Free	Free	Free	Free
RT Channelized	-	-	None	-	-	None	-	-	None	-	-	None
Storage Length	-	-	-	60	-	-	75	-	75	80	-	-
Veh in Median Storage, #	-	0	-	-	0	-	-	0	-	-	0	-
Grade, %	-	0	-	-	0	-	-	0	-	-	0	-
Peak Hour Factor	92	92	92	92	92	92	92	92	92	92	92	92
Heavy Vehicles, %	2	2	2	2	2	2	2	2	2	2	2	2
Mvmt Flow	120	4	76	202	10	65	89	211	162	68	209	41

Major/Minor	Minor2		Minor1		Major1		Major2					
Conflicting Flow All	874	917	230	795	775	211	250	0	0	373	0	0
Stage 1	366	366	-	389	389	-	-	-	-	-	-	-
Stage 2	508	551	-	406	386	-	-	-	-	-	-	-
Critical Hdwy	7.12	6.52	6.22	7.12	6.52	6.22	4.12	-	-	4.12	-	-
Critical Hdwy Stg 1	6.12	5.52	-	6.12	5.52	-	-	-	-	-	-	-
Critical Hdwy Stg 2	6.12	5.52	-	6.12	5.52	-	-	-	-	-	-	-
Follow-up Hdwy	3.518	4.018	3.318	3.518	4.018	3.318	2.218	-	-	2.218	-	-
Pot Cap-1 Maneuver	270	272	809	305	329	829	1316	-	-	1185	-	-
Stage 1	653	623	-	635	608	-	-	-	-	-	-	-
Stage 2	547	515	-	622	610	-	-	-	-	-	-	-
Platoon blocked, %								-	-	-	-	-
Mov Cap-1 Maneuver	220	239	809	247	289	829	1316	-	-	1185	-	-
Mov Cap-2 Maneuver	220	239	-	247	289	-	-	-	-	-	-	-
Stage 1	609	587	-	592	567	-	-	-	-	-	-	-
Stage 2	462	480	-	527	575	-	-	-	-	-	-	-

Approach	EB		WB		NB		SB	
HCM Control Delay, s	36.7		48.7		1.5		1.8	
HCM LOS	E		E					

Minor Lane/Major Mvmt	NBL	NBT	NBR	EBLn1	WBLn1	WBLn2	SBL	SBT	SBR
Capacity (veh/h)	1316	-	-	305	247	667	1185	-	-
HCM Lane V/C Ratio	0.068	-	-	0.656	0.819	0.112	0.058	-	-
HCM Control Delay (s)	7.9	-	-	36.7	62.6	11.1	8.2	-	-
HCM Lane LOS	A	-	-	E	F	B	A	-	-
HCM 95th %tile Q(veh)	0.2	-	-	4.3	6.3	0.4	0.2	-	-

HCM 6th AWSC
6: Allen Street & Front Street

Background Traffic Volumes
Year 2041 - Saturday Peak Hour

Intersection	
Intersection Delay, s/veh	16.8
Intersection LOS	C

Movement	EBL	EBR	NBL	NBT	SBT	SBR
Lane Configurations	↙	↗	↙	↗	↗	↗
Traffic Vol, veh/h	288	142	118	252	239	256
Future Vol, veh/h	288	142	118	252	239	256
Peak Hour Factor	0.92	0.92	0.92	0.92	0.92	0.92
Heavy Vehicles, %	2	2	2	2	2	2
Mvmt Flow	313	154	128	274	260	278
Number of Lanes	1	1	1	1	1	1

Approach	EB	NB	SB
Opposing Approach		SB	NB
Opposing Lanes	0	2	2
Conflicting Approach Left	SB	EB	
Conflicting Lanes Left	2	2	0
Conflicting Approach Right	NB		EB
Conflicting Lanes Right	2	0	2
HCM Control Delay	19.4	15.9	15.1
HCM LOS	C	C	C

Lane	NBLn1	NBLn2	EBLn1	EBLn2	SBLn1	SBLn2
Vol Left, %	100%	0%	100%	0%	0%	0%
Vol Thru, %	0%	100%	0%	0%	100%	0%
Vol Right, %	0%	0%	0%	100%	0%	100%
Sign Control	Stop	Stop	Stop	Stop	Stop	Stop
Traffic Vol by Lane	118	252	288	142	239	256
LT Vol	118	0	288	0	0	0
Through Vol	0	252	0	0	239	0
RT Vol	0	0	0	142	0	256
Lane Flow Rate	128	274	313	154	260	278
Geometry Grp	7	7	7	7	7	7
Degree of Util (X)	0.265	0.527	0.652	0.269	0.49	0.47
Departure Headway (Hd)	7.439	6.927	7.503	6.283	6.797	6.081
Convergence, Y/N	Yes	Yes	Yes	Yes	Yes	Yes
Cap	480	518	479	568	527	587
Service Time	5.227	4.715	5.279	4.058	4.581	3.864
HCM Lane V/C Ratio	0.267	0.529	0.653	0.271	0.493	0.474
HCM Control Delay	12.9	17.3	23.4	11.4	16	14.2
HCM Lane LOS	B	C	C	B	C	B
HCM 95th-tile Q	1.1	3	4.6	1.1	2.7	2.5

HCM 6th TWSC
7: Private Access/Brewer Court & Alexander Place

Background Traffic Volumes
Year 2041 - Saturday Peak Hour

Intersection												
Int Delay, s/veh	7.7											
Movement	EBL	EBT	EBR	WBL	WBT	WBR	NBL	NBT	NBR	SBL	SBT	SBR
Lane Configurations	↕			↕			↕			↕		
Traffic Vol, veh/h	204	20	5	0	38	0	3	0	0	0	0	235
Future Vol, veh/h	204	20	5	0	38	0	3	0	0	0	0	235
Conflicting Peds, #/hr	0	0	0	0	0	0	0	0	0	0	0	0
Sign Control	Free	Free	Free	Free	Free	Free	Stop	Stop	Stop	Stop	Stop	Stop
RT Channelized	-	-	None	-	-	None	-	-	None	-	-	None
Storage Length	-	-	-	-	-	-	-	-	-	-	-	-
Veh in Median Storage, #	-	0	-	-	0	-	-	0	-	-	0	-
Grade, %	-	0	-	-	0	-	-	0	-	-	0	-
Peak Hour Factor	92	92	92	92	92	92	92	92	92	92	92	92
Heavy Vehicles, %	2	2	2	2	2	2	2	2	2	2	2	2
Mvmt Flow	222	22	5	0	41	0	3	0	0	0	0	255

Major/Minor	Major1		Major2		Minor1		Minor2					
Conflicting Flow All	41	0	0	27	0	0	638	510	25	510	512	41
Stage 1	-	-	-	-	-	-	469	469	-	41	41	-
Stage 2	-	-	-	-	-	-	169	41	-	469	471	-
Critical Hdwy	4.12	-	-	4.12	-	-	7.12	6.52	6.22	7.12	6.52	6.22
Critical Hdwy Stg 1	-	-	-	-	-	-	6.12	5.52	-	6.12	5.52	-
Critical Hdwy Stg 2	-	-	-	-	-	-	6.12	5.52	-	6.12	5.52	-
Follow-up Hdwy	2.218	-	-	2.218	-	-	3.518	4.018	3.318	3.518	4.018	3.318
Pot Cap-1 Maneuver	1568	-	-	1587	-	-	389	467	1051	474	465	1030
Stage 1	-	-	-	-	-	-	575	561	-	974	861	-
Stage 2	-	-	-	-	-	-	833	861	-	575	560	-
Platoon blocked, %	-	-	-	-	-	-	-	-	-	-	-	-
Mov Cap-1 Maneuver	1568	-	-	1587	-	-	260	400	1051	422	398	1030
Mov Cap-2 Maneuver	-	-	-	-	-	-	260	400	-	422	398	-
Stage 1	-	-	-	-	-	-	492	480	-	834	861	-
Stage 2	-	-	-	-	-	-	626	861	-	492	479	-

Approach	EB	WB	NB	SB
HCM Control Delay, s	6.8	0	19	9.6
HCM LOS			C	A

Minor Lane/Major Mvmt	NBLn1	EBL	EBT	EBR	WBL	WBT	WBR	SBLn1
Capacity (veh/h)	260	1568	-	-	1587	-	-	1030
HCM Lane V/C Ratio	0.013	0.141	-	-	-	-	-	0.248
HCM Control Delay (s)	19	7.7	0	-	0	-	-	9.6
HCM Lane LOS	C	A	A	-	A	-	-	A
HCM 95th %tile Q(veh)	0	0.5	-	-	0	-	-	1

Timings
1: Front Street & Founders Parkway (SH 86)

Total Traffic Volumes
Year 2023 - AM Peak Hour

Lane Group	EBL	EBT	EBR	WBL	WBT	WBR	NBL	NBT	NBR	SBL	SBT	SBR
Lane Configurations												
Traffic Volume (vph)	178	42	37	19	30	60	59	1526	10	53	901	166
Future Volume (vph)	178	42	37	19	30	60	59	1526	10	53	901	166
Satd. Flow (prot)	3433	1863	1583	1770	3189	0	1770	5080	0	1770	4968	0
Flt Permitted	0.549			0.727			0.209			0.105		
Satd. Flow (perm)	1984	1863	1583	1354	3189	0	389	5080	0	196	4968	0
Satd. Flow (RTOR)			164		65			1			57	
Lane Group Flow (vph)	193	46	40	21	98	0	64	1670	0	58	1159	0
Turn Type	pm+pt	NA	Perm	pm+pt	NA		pm+pt	NA		pm+pt	NA	
Protected Phases	7	4		3	8		1	6		5	2	
Permitted Phases	4		4	8			6			2		
Detector Phase	7	4	4	3	8		1	6		5	2	
Switch Phase												
Minimum Initial (s)	3.0	5.0	5.0	3.0	5.0		3.0	20.0		3.0	20.0	
Minimum Split (s)	10.0	11.0	11.0	10.0	11.0		10.0	26.0		10.0	26.0	
Total Split (s)	11.0	12.0	12.0	18.0	19.0		10.0	80.0		10.0	80.0	
Total Split (%)	9.2%	10.0%	10.0%	15.0%	15.8%		8.3%	66.7%		8.3%	66.7%	
Yellow Time (s)	3.0	4.0	4.0	3.0	4.0		3.0	4.0		3.0	4.0	
All-Red Time (s)	2.0	2.0	2.0	2.0	2.0		2.0	2.0		2.0	2.0	
Lost Time Adjust (s)	0.0	0.0	0.0	0.0	0.0		0.0	0.0		0.0	0.0	
Total Lost Time (s)	5.0	6.0	6.0	5.0	6.0		5.0	6.0		5.0	6.0	
Lead/Lag	Lead	Lag	Lag	Lead	Lag		Lead	Lag		Lead	Lag	
Lead-Lag Optimize?	Yes	Yes	Yes	Yes	Yes		Yes	Yes		Yes	Yes	
Recall Mode	None	None	None	None	None		None	C-Max		None	C-Max	
Act Effct Green (s)	17.6	14.2	14.2	16.1	8.3		85.7	79.8		85.6	79.7	
Actuated g/C Ratio	0.15	0.12	0.12	0.13	0.07		0.71	0.66		0.71	0.66	
v/c Ratio	0.53	0.21	0.12	0.10	0.35		0.18	0.49		0.27	0.35	
Control Delay	49.9	52.3	0.7	41.4	24.2		5.8	11.4		7.7	9.3	
Queue Delay	0.0	0.0	0.0	0.0	0.0		0.0	0.0		0.0	0.0	
Total Delay	49.9	52.3	0.7	41.4	24.2		5.8	11.4		7.7	9.3	
LOS	D	D	A	D	C		A	B		A	A	
Approach Delay		43.2			27.3			11.2			9.2	
Approach LOS		D			C			B			A	
Queue Length 50th (ft)	69	32	0	14	13		10	222		9	127	
Queue Length 95th (ft)	99	73	0	36	39		26	292		25	173	
Internal Link Dist (ft)		695			413			423			624	
Turn Bay Length (ft)	285		285	195			175			455		
Base Capacity (vph)	363	220	332	274	403		347	3377		218	3319	
Starvation Cap Reductn	0	0	0	0	0		0	0		0	0	
Spillback Cap Reductn	0	0	0	0	0		0	0		0	0	
Storage Cap Reductn	0	0	0	0	0		0	0		0	0	
Reduced v/c Ratio	0.53	0.21	0.12	0.08	0.24		0.18	0.49		0.27	0.35	

Intersection Summary









Cycle Length: 120
 Actuated Cycle Length: 120
 Offset: 42 (35%), Referenced to phase 2:SBTL and 6:NBTL, Start of Green
 Natural Cycle: 60
 Control Type: Actuated-Coordinated

Timings
 1: Front Street & Founders Parkway (SH 86)

Total Traffic Volumes
 Year 2023 - AM Peak Hour

Maximum v/c Ratio: 0.53	
Intersection Signal Delay: 13.7	Intersection LOS: B
Intersection Capacity Utilization 59.0%	ICU Level of Service B
Analysis Period (min) 15	

Splits and Phases: 1: Front Street & Founders Parkway (SH 86)

 Ø1	 Ø2 (R)	 Ø3	 Ø4
10 s	80 s	18 s	12 s
 Ø5	 Ø6 (R)	 Ø7	 Ø8
10 s	80 s	11 s	19 s

Timings
2: Allen Way & Founders Parkway (SH 86)

Total Traffic Volumes
Year 2023 - AM Peak Hour

Lane Group	EBL	EBT	EBR	WBL	WBT	WBR	NBL	NBT	NBR	SBL	SBT	SBR
Lane Configurations												
Traffic Volume (vph)	261	993	138	39	1602	137	98	21	55	66	15	318
Future Volume (vph)	261	993	138	39	1602	137	98	21	55	66	15	318
Satd. Flow (prot)	3433	4994	0	1770	5085	1583	1770	1662	0	1770	1863	2787
Flt Permitted	0.950			0.216			0.552			0.703		
Satd. Flow (perm)	3433	4994	0	402	5085	1583	1028	1662	0	1310	1863	2787
Satd. Flow (RTOR)		42				149		60				302
Lane Group Flow (vph)	284	1229	0	42	1741	149	107	83	0	72	16	346
Turn Type	Prot	NA		pm+pt	NA	Perm	pm+pt	NA		pm+pt	NA	Perm
Protected Phases	5	2		1	6		7	4		3	8	
Permitted Phases				6		6	4			8		8
Detector Phase	5	2		1	6	6	7	4		3	8	8
Switch Phase												
Minimum Initial (s)	5.0	20.0		5.0	20.0	20.0	5.0	5.0		5.0	5.0	5.0
Minimum Split (s)	10.0	26.0		10.0	26.0	26.0	10.0	11.0		11.0	11.0	11.0
Total Split (s)	15.0	83.0		11.0	79.0	79.0	13.0	12.0		14.0	13.0	13.0
Total Split (%)	12.5%	69.2%		9.2%	65.8%	65.8%	10.8%	10.0%		11.7%	10.8%	10.8%
Yellow Time (s)	3.0	4.0		3.0	4.0	4.0	3.0	4.0		3.0	4.0	4.0
All-Red Time (s)	2.0	2.0		2.0	2.0	2.0	2.0	2.0		2.0	2.0	2.0
Lost Time Adjust (s)	0.0	0.0		0.0	0.0	0.0	0.0	0.0		0.0	0.0	0.0
Total Lost Time (s)	5.0	6.0		5.0	6.0	6.0	5.0	6.0		5.0	6.0	6.0
Lead/Lag	Lead	Lead		Lag	Lag	Lag	Lead	Lag		Lead	Lag	Lag
Lead-Lag Optimize?	Yes	Yes		Yes	Yes	Yes	Yes	Yes		Yes	Yes	Yes
Recall Mode	None	C-Min		None	C-Min	C-Min	None	None		None	None	None
Act Effct Green (s)	15.2	64.6		65.1	64.1	64.1	22.1	11.1		18.0	7.2	7.2
Actuated g/C Ratio	0.13	0.54		0.54	0.53	0.53	0.18	0.09		0.15	0.06	0.06
v/c Ratio	0.65	0.45		0.10	0.64	0.16	0.41	0.40		0.31	0.14	0.77
Control Delay	62.6	19.1		16.3	21.5	2.7	44.3	25.9		44.6	60.3	26.1
Queue Delay	0.0	0.0		0.0	0.0	0.0	0.0	0.0		0.0	0.0	0.0
Total Delay	62.6	19.2		16.3	21.5	2.7	44.3	25.9		44.6	60.3	26.1
LOS	E	B		B	C	A	D	C		D	E	C
Approach Delay		27.3			20.0			36.3			30.5	
Approach LOS		C			B			D			C	
Queue Length 50th (ft)	112	229		15	352	0	70	17		50	12	0
Queue Length 95th (ft)	#212	239		31	371	30	120	69		97	m37	#89
Internal Link Dist (ft)		347			406			277			368	
Turn Bay Length (ft)	300			330			80			120		100
Base Capacity (vph)	434	3408		435	3093	1021	260	208		244	119	461
Starvation Cap Reductn	0	524		0	0	0	0	0		0	0	0
Spillback Cap Reductn	0	0		0	0	0	0	0		0	0	0
Storage Cap Reductn	0	0		0	0	0	0	0		0	0	0
Reduced v/c Ratio	0.65	0.43		0.10	0.56	0.15	0.41	0.40		0.30	0.13	0.75

Intersection Summary

Cycle Length: 120
 Actuated Cycle Length: 120
 Offset: 36 (30%), Referenced to phase 2:EBT and 6:WBTL, Start of Green
 Natural Cycle: 60
 Control Type: Actuated-Coordinated

Timings
 2: Allen Way & Founders Parkway (SH 86)

Total Traffic Volumes
 Year 2023 - AM Peak Hour

Maximum v/c Ratio: 0.77

Intersection Signal Delay: 24.6

Intersection LOS: C

Intersection Capacity Utilization 64.7%

ICU Level of Service C

Analysis Period (min) 15

95th percentile volume exceeds capacity, queue may be longer.

Queue shown is maximum after two cycles.

m Volume for 95th percentile queue is metered by upstream signal.

Splits and Phases: 2: Allen Way & Founders Parkway (SH 86)



















Ø2 (R)		Ø1		Ø3		Ø4	
83 s		11 s		14 s		12 s	
Ø5		Ø6 (R)		Ø7		Ø8	
15 s		79 s		13 s		13 s	

Timings

3: I-25 NB Off-Ramp/I-25 NB On-Ramp & Founders Parkway (SH 86)

Total Traffic Volumes

Year 2023 - AM Peak Hour

												
Lane Group	EBL	EBT	EBR	WBL	WBT	WBR	NBL	NBT	NBR	SBL	SBT	SBR
Lane Configurations												
Traffic Volume (vph)	0	1019	550	0	780	1334	225	0	224	0	0	0
Future Volume (vph)	0	1019	550	0	780	1334	225	0	224	0	0	0
Satd. Flow (prot)	0	4691	1362	0	3156	1441	3433	0	2787	0	0	0
Flt Permitted							0.950					
Satd. Flow (perm)	0	4691	1362	0	3156	1441	3433	0	2787	0	0	0
Satd. Flow (RTOR)		70	383		417	725			232			
Lane Group Flow (vph)	0	1323	383	0	1573	725	245	0	243	0	0	0
Turn Type		NA	Free		NA	Free	Prot		Prot			
Protected Phases		2			2		4		4			
Permitted Phases			Free			Free						
Detector Phase		2			2		4		4			
Switch Phase												
Minimum Initial (s)		20.0			20.0		5.0		5.0			
Minimum Split (s)		26.0			26.0		10.5		10.5			
Total Split (s)		89.0			89.0		31.0		31.0			
Total Split (%)		74.2%			74.2%		25.8%		25.8%			
Yellow Time (s)		4.0			4.0		3.5		3.5			
All-Red Time (s)		2.0			2.0		2.0		2.0			
Lost Time Adjust (s)		0.0			0.0		0.0		0.0			
Total Lost Time (s)		6.0			6.0		5.5		5.5			
Lead/Lag												
Lead-Lag Optimize?												
Recall Mode		C-Max			C-Max		None		None			
Act Effct Green (s)		94.6	120.0		94.6	120.0	13.9		13.9			
Actuated g/C Ratio		0.79	1.00		0.79	1.00	0.12		0.12			
v/c Ratio		0.36	0.28		0.61	0.50	0.62		0.46			
Control Delay		4.0	0.5		5.0	3.6	57.2		10.0			
Queue Delay		0.0	0.0		0.3	0.0	0.0		0.0			
Total Delay		4.0	0.5		5.3	3.6	57.2		10.0			
LOS		A	A		A	A	E		A			
Approach Delay		3.2			4.8			33.7				
Approach LOS		A			A			C				
Queue Length 50th (ft)		89	0		69	69	94		4			
Queue Length 95th (ft)		127	0		51	125	132		44			
Internal Link Dist (ft)		649			347			213			215	
Turn Bay Length (ft)			500						100			
Base Capacity (vph)		3713	1362		2576	1441	729		774			
Starvation Cap Reductn		0	0		390	0	0		0			
Spillback Cap Reductn		29	0		0	0	0		1			
Storage Cap Reductn		0	0		0	0	0		0			
Reduced v/c Ratio		0.36	0.28		0.72	0.50	0.34		0.31			
Intersection Summary												
Cycle Length: 120												
Actuated Cycle Length: 120												
Offset: 35 (29%), Referenced to phase 2:EBWB, Start of Green												
Natural Cycle: 45												
Control Type: Actuated-Coordinated												

Timings

3: I-25 NB Off-Ramp/I-25 NB On-Ramp & Founders Parkway (SH 86)

Total Traffic Volumes

Year 2023 - AM Peak Hour

Maximum v/c Ratio: 0.62

Intersection Signal Delay: 7.3

Intersection LOS: A

Intersection Capacity Utilization 50.6%

ICU Level of Service A























Analysis Period (min) 15

Splits and Phases: 3: I-25 NB Off-Ramp/I-25 NB On-Ramp & Founders Parkway (SH 86)

 Ø2 (R)	 Ø4
89 s	31 s

Timings
4: Allen Way & Allen Street

Total Traffic Volumes
Year 2023 - AM Peak Hour

												
Lane Group	EBL	EBT	EBR	WBL	WBT	WBR	NBL	NBT	NBR	SBL	SBT	SBR
Lane Configurations												
Traffic Volume (vph)	7	12	92	71	19	56	119	257	43	22	225	4
Future Volume (vph)	7	12	92	71	19	56	119	257	43	22	225	4
Satd. Flow (prot)	1770	1615	0	1770	1863	1583	1770	3539	1583	0	3518	0
Flt Permitted	0.449			0.684			0.584				0.920	
Satd. Flow (perm)	836	1615	0	1274	1863	1583	1088	3539	1583	0	3250	0
Satd. Flow (RTOR)		100				218			218		3	
Lane Group Flow (vph)	8	113	0	77	21	61	129	279	47	0	273	0
Turn Type	pm+pt	NA		Perm	NA	Perm	Perm	NA	Perm	D.P+P	NA	
Protected Phases	3	8			4			6		5	2	
Permitted Phases	8			4		4	6		6	6		
Detector Phase	3	8		4	4	4	6	6	6	5	2	
Switch Phase												
Minimum Initial (s)	3.0	5.0		5.0	5.0	5.0	5.0	5.0	5.0	3.0	5.0	
Minimum Split (s)	8.0	10.0		10.0	10.0	10.0	10.0	10.0	10.0	8.0	10.0	
Total Split (s)	12.0	27.0		15.0	15.0	15.0	21.0	21.0	21.0	12.0	33.0	
Total Split (%)	20.0%	45.0%		25.0%	25.0%	25.0%	35.0%	35.0%	35.0%	20.0%	55.0%	
Yellow Time (s)	3.0	3.0		3.0	3.0	3.0	3.0	3.0	3.0	3.0	3.0	
All-Red Time (s)	2.0	2.0		2.0	2.0	2.0	2.0	2.0	2.0	2.0	2.0	
Lost Time Adjust (s)	0.0	0.0		0.0	0.0	0.0	0.0	0.0	0.0		0.0	
Total Lost Time (s)	5.0	5.0		5.0	5.0	5.0	5.0	5.0	5.0		5.0	
Lead/Lag	Lead			Lag	Lag	Lag	Lag	Lag	Lag	Lead		
Lead-Lag Optimize?	Yes			Yes	Yes	Yes	Yes	Yes	Yes	Yes		
Recall Mode	None	None		None	None	None	C-Min	C-Min	C-Min	None	C-Min	
Act Effct Green (s)	11.0	11.0		8.7	8.7	8.7	42.1	42.1	42.1		42.1	
Actuated g/C Ratio	0.18	0.18		0.14	0.14	0.14	0.70	0.70	0.70		0.70	
v/c Ratio	0.03	0.30		0.42	0.08	0.15	0.17	0.11	0.04		0.12	
Control Delay	16.0	7.3		29.5	21.3	0.7	4.2	2.1	0.0		5.4	
Queue Delay	0.0	0.0		0.0	0.0	0.0	0.0	0.0	0.0		0.0	
Total Delay	16.0	7.3		29.5	21.3	0.7	4.2	2.1	0.0		5.4	
LOS	B	A		C	C	A	A	A	A		A	
Approach Delay		7.9			17.4			2.5			5.4	
Approach LOS		A			B			A			A	
Queue Length 50th (ft)	3	4		26	7	0	4	4	0		14	
Queue Length 95th (ft)	9	29		58	22	0	m33	22	m0		48	
Internal Link Dist (ft)		422			420			368			300	
Turn Bay Length (ft)	60			95		65	70		95			
Base Capacity (vph)	266	659		220	323	454	764	2484	1176		2290	
Starvation Cap Reductn	0	0		0	0	0	0	0	0		0	
Spillback Cap Reductn	0	0		0	0	0	0	0	0		0	
Storage Cap Reductn	0	0		0	0	0	0	0	0		0	
Reduced v/c Ratio	0.03	0.17		0.35	0.07	0.13	0.17	0.11	0.04		0.12	

Intersection Summary

Cycle Length: 60
 Actuated Cycle Length: 60
 Offset: 31 (52%), Referenced to phase 2:SBT and 6:NBSB, Start of Green
 Natural Cycle: 45
 Control Type: Actuated-Coordinated

Timings
4: Allen Way & Allen Street

Total Traffic Volumes
Year 2023 - AM Peak Hour

Maximum v/c Ratio: 0.42

Intersection Signal Delay: 6.3

Intersection LOS: A

Intersection Capacity Utilization 37.2%

ICU Level of Service A

Analysis Period (min) 15

m Volume for 95th percentile queue is metered by upstream signal.

Splits and Phases: 4: Allen Way & Allen Street

↓ Ø2 (R)	↓	↗ Ø3	← Ø4
33 s		12 s	15 s
↘ Ø5	↓	↖ Ø8	
12 s	↑ Ø6 (R)	27 s	
	21 s		

HCM 6th TWSC
5: Allen Street & Alexander Place

Total Traffic Volumes
Year 2023 - AM Peak Hour

Intersection												
Int Delay, s/veh	5.7											
Movement	EBL	EBT	EBR	WBL	WBT	WBR	NBL	NBT	NBR	SBL	SBT	SBR
Lane Configurations		↔		↵	↶		↵	↶	↷	↵	↶	
Traffic Vol, veh/h	28	4	18	40	4	98	23	72	47	38	33	15
Future Vol, veh/h	28	4	18	40	4	98	23	72	47	38	33	15
Conflicting Peds, #/hr	0	0	0	0	0	0	0	0	0	0	0	0
Sign Control	Stop	Stop	Stop	Stop	Stop	Stop	Free	Free	Free	Free	Free	Free
RT Channelized	-	-	None	-	-	None	-	-	None	-	-	None
Storage Length	-	-	-	60	-	-	75	-	75	80	-	-
Veh in Median Storage, #	-	0	-	-	0	-	-	0	-	-	0	-
Grade, %	-	0	-	-	0	-	-	0	-	-	0	-
Peak Hour Factor	92	92	92	92	92	92	92	92	92	92	92	92
Heavy Vehicles, %	2	2	2	2	2	2	2	2	2	2	2	2
Mvmt Flow	30	4	20	43	4	107	25	78	51	41	36	16

Major/Minor	Minor2		Minor1		Major1		Major2					
Conflicting Flow All	335	305	44	266	262	78	52	0	0	129	0	0
Stage 1	126	126	-	128	128	-	-	-	-	-	-	-
Stage 2	209	179	-	138	134	-	-	-	-	-	-	-
Critical Hdwy	7.12	6.52	6.22	7.12	6.52	6.22	4.12	-	-	4.12	-	-
Critical Hdwy Stg 1	6.12	5.52	-	6.12	5.52	-	-	-	-	-	-	-
Critical Hdwy Stg 2	6.12	5.52	-	6.12	5.52	-	-	-	-	-	-	-
Follow-up Hdwy	3.518	4.018	3.318	3.518	4.018	3.318	2.218	-	-	2.218	-	-
Pot Cap-1 Maneuver	619	608	1026	687	643	983	1554	-	-	1457	-	-
Stage 1	878	792	-	876	790	-	-	-	-	-	-	-
Stage 2	793	751	-	865	785	-	-	-	-	-	-	-
Platoon blocked, %								-	-	-	-	-
Mov Cap-1 Maneuver	530	581	1026	648	615	983	1554	-	-	1457	-	-
Mov Cap-2 Maneuver	530	581	-	648	615	-	-	-	-	-	-	-
Stage 1	864	770	-	862	777	-	-	-	-	-	-	-
Stage 2	692	739	-	820	763	-	-	-	-	-	-	-

Approach	EB		WB		NB		SB	
HCM Control Delay, s	11.1		9.7		1.2		3.3	
HCM LOS	B		A					

Minor Lane/Major Mvmt	NBL	NBT	NBR	EBLn1	WBLn1	WBLn2	SBL	SBT	SBR
Capacity (veh/h)	1554	-	-	647	648	960	1457	-	-
HCM Lane V/C Ratio	0.016	-	-	0.084	0.067	0.115	0.028	-	-
HCM Control Delay (s)	7.4	-	-	11.1	11	9.2	7.5	-	-
HCM Lane LOS	A	-	-	B	B	A	A	-	-
HCM 95th %tile Q(veh)	0	-	-	0.3	0.2	0.4	0.1	-	-

HCM 6th AWSC
6: Allen Street & Front Street

Total Traffic Volumes
Year 2023 - AM Peak Hour

Intersection	
Intersection Delay, s/veh	8.3
Intersection LOS	A

Movement	EBL	EBR	NBL	NBT	SBT	SBR
Lane Configurations	↙	↗	↙	↑	↑	↗
Traffic Vol, veh/h	63	40	55	94	68	51
Future Vol, veh/h	63	40	55	94	68	51
Peak Hour Factor	0.92	0.92	0.92	0.92	0.92	0.92
Heavy Vehicles, %	2	2	2	2	2	2
Mvmt Flow	68	43	60	102	74	55
Number of Lanes	1	1	1	1	1	1

Approach	EB	NB	SB
Opposing Approach		SB	NB
Opposing Lanes	0	2	2
Conflicting Approach Left	SB	EB	
Conflicting Lanes Left	2	2	0
Conflicting Approach Right	NB		EB
Conflicting Lanes Right	2	0	2
HCM Control Delay	8.5	8.6	7.9
HCM LOS	A	A	A

Lane	NBLn1	NBLn2	EBLn1	EBLn2	SBLn1	SBLn2
Vol Left, %	100%	0%	100%	0%	0%	0%
Vol Thru, %	0%	100%	0%	0%	100%	0%
Vol Right, %	0%	0%	0%	100%	0%	100%
Sign Control	Stop	Stop	Stop	Stop	Stop	Stop
Traffic Vol by Lane	55	94	63	40	68	51
LT Vol	55	0	63	0	0	0
Through Vol	0	94	0	0	68	0
RT Vol	0	0	0	40	0	51
Lane Flow Rate	60	102	68	43	74	55
Geometry Grp	7	7	7	7	7	7
Degree of Util (X)	0.09	0.14	0.109	0.055	0.102	0.066
Departure Headway (Hd)	5.445	4.943	5.73	4.526	4.985	4.282
Convergence, Y/N	Yes	Yes	Yes	Yes	Yes	Yes
Cap	660	727	627	793	721	838
Service Time	3.163	2.661	3.45	2.246	2.703	2
HCM Lane V/C Ratio	0.091	0.14	0.108	0.054	0.103	0.066
HCM Control Delay	8.7	8.5	9.2	7.5	8.3	7.3
HCM Lane LOS	A	A	A	A	A	A
HCM 95th-tile Q	0.3	0.5	0.4	0.2	0.3	0.2

HCM 6th TWSC
7: Private Access/Brewer Court & Alexander Place

Total Traffic Volumes
Year 2023 - AM Peak Hour

Intersection												
Int Delay, s/veh	5.4											
Movement	EBL	EBT	EBR	WBL	WBT	WBR	NBL	NBT	NBR	SBL	SBT	SBR
Lane Configurations	↕			↕			↕			↕		
Traffic Vol, veh/h	48	14	29	0	21	0	12	2	0	0	2	54
Future Vol, veh/h	48	14	29	0	21	0	12	2	0	0	2	54
Conflicting Peds, #/hr	0	0	0	0	0	0	0	0	0	0	0	0
Sign Control	Free	Free	Free	Free	Free	Free	Stop	Stop	Stop	Stop	Stop	Stop
RT Channelized	-	-	None	-	-	None	-	-	None	-	-	None
Storage Length	-	-	-	-	-	-	-	-	-	-	-	-
Veh in Median Storage, #	-	0	-	-	0	-	-	0	-	-	0	-
Grade, %	-	0	-	-	0	-	-	0	-	-	0	-
Peak Hour Factor	92	92	92	92	92	92	92	92	92	92	92	92
Heavy Vehicles, %	2	2	2	2	2	2	2	2	2	2	2	2
Mvmt Flow	52	15	32	0	23	0	13	2	0	0	2	59

Major/Minor	Major1		Major2		Minor1			Minor2				
Conflicting Flow All	23	0	0	47	0	0	189	158	31	159	174	23
Stage 1	-	-	-	-	-	-	135	135	-	23	23	-
Stage 2	-	-	-	-	-	-	54	23	-	136	151	-
Critical Hdwy	4.12	-	-	4.12	-	-	7.12	6.52	6.22	7.12	6.52	6.22
Critical Hdwy Stg 1	-	-	-	-	-	-	6.12	5.52	-	6.12	5.52	-
Critical Hdwy Stg 2	-	-	-	-	-	-	6.12	5.52	-	6.12	5.52	-
Follow-up Hdwy	2.218	-	-	2.218	-	-	3.518	4.018	3.318	3.518	4.018	3.318
Pot Cap-1 Maneuver	1592	-	-	1560	-	-	771	734	1043	807	719	1054
Stage 1	-	-	-	-	-	-	868	785	-	995	876	-
Stage 2	-	-	-	-	-	-	958	876	-	867	772	-
Platoon blocked, %	-	-	-	-	-	-	-	-	-	-	-	-
Mov Cap-1 Maneuver	1592	-	-	1560	-	-	708	709	1043	784	695	1054
Mov Cap-2 Maneuver	-	-	-	-	-	-	708	709	-	784	695	-
Stage 1	-	-	-	-	-	-	838	758	-	961	876	-
Stage 2	-	-	-	-	-	-	902	876	-	835	746	-

Approach	EB	WB	NB	SB
HCM Control Delay, s	3.9	0	10.2	8.7
HCM LOS			B	A

Minor Lane/Major Mvmt	NBLn1	EBL	EBT	EBR	WBL	WBT	WBR	SBLn1
Capacity (veh/h)	708	1592	-	-	1560	-	-	1035
HCM Lane V/C Ratio	0.021	0.033	-	-	-	-	-	0.059
HCM Control Delay (s)	10.2	7.3	0	-	0	-	-	8.7
HCM Lane LOS	B	A	A	-	A	-	-	A
HCM 95th %tile Q(veh)	0.1	0.1	-	-	0	-	-	0.2

Timings
1: Front Street & Founders Parkway (SH 86)

Total Traffic Volumes
Year 2023 - PM Peak Hour

Lane Group	EBL	EBT	EBR	WBL	WBT	WBR	NBL	NBT	NBR	SBL	SBT	SBR
Lane Configurations												
Traffic Volume (vph)	321	122	177	32	81	90	103	1386	15	165	1745	354
Future Volume (vph)	321	122	177	32	81	90	103	1386	15	165	1745	354
Satd. Flow (prot)	3433	1863	1583	1770	3260	0	1770	5075	0	1770	4958	0
Flt Permitted	0.445			0.672			0.056			0.116		
Satd. Flow (perm)	1608	1863	1583	1252	3260	0	104	5075	0	216	4958	0
Satd. Flow (RTOR)			164		98			2			71	
Lane Group Flow (vph)	349	133	192	35	186	0	112	1523	0	179	2282	0
Turn Type	pm+pt	NA	Perm	pm+pt	NA		pm+pt	NA		pm+pt	NA	
Protected Phases	7	4		3	8		1	6		5	2	
Permitted Phases	4		4	8			6			2		
Detector Phase	7	4	4	3	8		1	6		5	2	
Switch Phase												
Minimum Initial (s)	3.0	5.0	5.0	3.0	5.0		3.0	20.0		3.0	20.0	
Minimum Split (s)	10.0	11.0	11.0	10.0	11.0		10.0	26.0		10.0	26.0	
Total Split (s)	13.0	13.0	13.0	13.0	13.0		11.0	74.0		20.0	83.0	
Total Split (%)	10.8%	10.8%	10.8%	10.8%	10.8%		9.2%	61.7%		16.7%	69.2%	
Yellow Time (s)	3.0	4.0	4.0	3.0	4.0		3.0	4.0		3.0	4.0	
All-Red Time (s)	2.0	2.0	2.0	2.0	2.0		2.0	2.0		2.0	2.0	
Lost Time Adjust (s)	0.0	0.0	0.0	0.0	0.0		0.0	0.0		0.0	0.0	
Total Lost Time (s)	5.0	6.0	6.0	5.0	6.0		5.0	6.0		5.0	6.0	
Lead/Lag	Lead	Lag	Lag	Lead	Lag		Lead	Lag		Lead	Lag	
Lead-Lag Optimize?	Yes	Yes	Yes	Yes	Yes		Yes	Yes		Yes	Yes	
Recall Mode	None	None	None	None	None		None	C-Max		None	C-Max	
Act Effct Green (s)	18.1	12.3	12.3	15.1	7.0		80.1	73.1		87.2	77.0	
Actuated g/C Ratio	0.15	0.10	0.10	0.13	0.06		0.67	0.61		0.73	0.64	
v/c Ratio	0.96	0.70	0.62	0.19	0.66		0.74	0.49		0.63	0.71	
Control Delay	85.5	73.5	22.1	44.5	38.3		49.0	14.0		17.8	15.2	
Queue Delay	0.0	0.0	0.0	0.0	0.0		0.0	0.0		0.0	0.0	
Total Delay	85.5	73.5	22.1	44.5	38.3		49.0	14.0		17.8	15.2	
LOS	F	E	C	D	D		D	B		B	B	
Approach Delay		65.1			39.2			16.4			15.4	
Approach LOS		E			D			B			B	
Queue Length 50th (ft)	~131	~119	21	23	35		32	220		34	384	
Queue Length 95th (ft)	#201	#256	#133	53	74		#131	293		88	436	
Internal Link Dist (ft)		695			413			423			624	
Turn Bay Length (ft)	285		285	195			175			455		
Base Capacity (vph)	364	191	309	201	282		152	3093		354	3206	
Starvation Cap Reductn	0	0	0	0	0		0	0		0	0	
Spillback Cap Reductn	0	0	0	0	0		0	0		0	0	
Storage Cap Reductn	0	0	0	0	0		0	0		0	0	
Reduced v/c Ratio	0.96	0.70	0.62	0.17	0.66		0.74	0.49		0.51	0.71	

Intersection Summary

Cycle Length: 120
 Actuated Cycle Length: 120
 Offset: 112 (93%), Referenced to phase 2:SBTL and 6:NBTL, Start of Green
 Natural Cycle: 75
 Control Type: Actuated-Coordinated

Timings
 1: Front Street & Founders Parkway (SH 86)

Total Traffic Volumes
 Year 2023 - PM Peak Hour

Maximum v/c Ratio: 0.96

Intersection Signal Delay: 23.5

Intersection LOS: C

Intersection Capacity Utilization 79.9%

ICU Level of Service D

Analysis Period (min) 15









~ Volume exceeds capacity, queue is theoretically infinite.

Queue shown is maximum after two cycles.

95th percentile volume exceeds capacity, queue may be longer.































Queue shown is maximum after two cycles.

Splits and Phases: 1: Front Street & Founders Parkway (SH 86)

 Ø1	 Ø2 (P)	 Ø3	 Ø4
11 s	83 s	13 s	13 s
 Ø5	 Ø6 (R)	 Ø7	 Ø8
20 s	74 s	13 s	13 s

Timings
2: Allen Way & Founders Parkway (SH 86)

Total Traffic Volumes
Year 2023 - PM Peak Hour

												
Lane Group	EBL	EBT	EBR	WBL	WBT	WBR	NBL	NBT	NBR	SBL	SBT	SBR
Lane Configurations	 	  			  			 			 	 
Traffic Volume (vph)	394	2176	248	48	1620	130	163	30	51	68	59	439
Future Volume (vph)	394	2176	248	48	1620	130	163	30	51	68	59	439
Satd. Flow (prot)	3433	5009	0	1770	5085	1583	1770	1688	0	1770	1863	2787
Flt Permitted	0.950			0.066			0.527			0.700		
Satd. Flow (perm)	3433	5009	0	123	5085	1583	982	1688	0	1304	1863	2787
Satd. Flow (RTOR)		33				141		53				378
Lane Group Flow (vph)	428	2635	0	52	1761	141	177	88	0	74	64	477
Turn Type	Prot	NA		pm+pt	NA	Perm	pm+pt	NA		pm+pt	NA	Perm
Protected Phases	5	2		1	6		7	4		3	8	
Permitted Phases				6		6	4			8		8
Detector Phase	5	2		1	6	6	7	4		3	8	8
Switch Phase												
Minimum Initial (s)	5.0	20.0		5.0	20.0	20.0	5.0	5.0		5.0	5.0	5.0
Minimum Split (s)	10.0	26.0		10.0	26.0	26.0	10.0	11.0		11.0	11.0	11.0
Total Split (s)	20.0	83.0		11.0	74.0	74.0	13.0	13.0		13.0	13.0	13.0
Total Split (%)	16.7%	69.2%		9.2%	61.7%	61.7%	10.8%	10.8%		10.8%	10.8%	10.8%
Yellow Time (s)	3.0	4.0		3.0	4.0	4.0	3.0	4.0		3.0	4.0	4.0
All-Red Time (s)	2.0	2.0		2.0	2.0	2.0	2.0	2.0		2.0	2.0	2.0
Lost Time Adjust (s)	0.0	0.0		0.0	0.0	0.0	0.0	0.0		0.0	0.0	0.0
Total Lost Time (s)	5.0	6.0		5.0	6.0	6.0	5.0	6.0		5.0	6.0	6.0
Lead/Lag	Lead	Lead		Lag	Lag	Lag	Lead	Lag		Lead	Lag	Lag
Lead-Lag Optimize?	Yes	Yes		Yes	Yes	Yes	Yes	Yes		Yes	Yes	Yes
Recall Mode	None	C-Min		None	C-Min	C-Min	None	None		None	None	None
Act Effct Green (s)	16.0	77.9		67.5	65.5	65.5	18.8	11.0		15.9	7.1	7.1
Actuated g/C Ratio	0.13	0.65		0.56	0.55	0.55	0.16	0.09		0.13	0.06	0.06
v/c Ratio	0.93	0.81		0.35	0.63	0.15	0.82	0.44		0.37	0.58	0.92
Control Delay	79.9	12.2		33.4	19.9	2.3	76.1	32.8		50.7	79.2	40.5
Queue Delay	0.0	1.3		0.0	0.0	0.0	0.0	0.0		0.0	0.0	0.5
Total Delay	79.9	13.4		33.4	20.0	2.3	76.1	32.8		50.7	79.2	41.0
LOS	E	B		C	B	A	E	C		D	E	D
Approach Delay		22.7			19.0			61.7			46.1	
Approach LOS		C			B			E			D	
Queue Length 50th (ft)	182	187		17	319	0	126	27		50	53	57
Queue Length 95th (ft)	m#278	312		35	362	28	#229	#91		m94	m#99	#152
Internal Link Dist (ft)		347			406			277			368	
Turn Bay Length (ft)	300			330			80			120		100
Base Capacity (vph)	458	3272		151	2881	958	215	202		207	110	520
Starvation Cap Reductn	0	398		0	0	0	0	0		0	0	0
Spillback Cap Reductn	0	0		0	42	0	0	0		0	0	3
Storage Cap Reductn	0	0		0	0	0	0	0		0	0	0
Reduced v/c Ratio	0.93	0.92		0.34	0.62	0.15	0.82	0.44		0.36	0.58	0.92

Intersection Summary

Cycle Length: 120
 Actuated Cycle Length: 120
 Offset: 107 (89%), Referenced to phase 2:EBT and 6:WBTL, Start of Green
 Natural Cycle: 90
 Control Type: Actuated-Coordinated

Timings
 2: Allen Way & Founders Parkway (SH 86)

Total Traffic Volumes
 Year 2023 - PM Peak Hour

Maximum v/c Ratio: 0.93

Intersection Signal Delay: 25.7

Intersection LOS: C

Intersection Capacity Utilization 81.6%

ICU Level of Service D

Analysis Period (min) 15

95th percentile volume exceeds capacity, queue may be longer.

Queue shown is maximum after two cycles.

m Volume for 95th percentile queue is metered by upstream signal.

Splits and Phases: 2: Allen Way & Founders Parkway (SH 86)



















Ø2 (R)		Ø1		Ø3		Ø4	
83 s		11 s		13 s		13 s	
Ø5		Ø6 (R)		Ø7		Ø8	
20 s		74 s		13 s		13 s	

Timings

3: I-25 NB Off-Ramp/I-25 NB On-Ramp & Founders Parkway (SH 86)

Total Traffic Volumes

Year 2023 - PM Peak Hour

												
Lane Group	EBL	EBT	EBR	WBL	WBT	WBR	NBL	NBT	NBR	SBL	SBT	SBR
Lane Configurations												
Traffic Volume (vph)	0	2458	584	0	1229	1004	415	0	368	0	0	0
Future Volume (vph)	0	2458	584	0	1229	1004	415	0	368	0	0	0
Satd. Flow (prot)	0	4787	1362	0	3285	1441	3433	0	2787	0	0	0
Flt Permitted							0.950					
Satd. Flow (perm)	0	4787	1362	0	3285	1441	3433	0	2787	0	0	0
Satd. Flow (RTOR)		6	361		53	424			27			
Lane Group Flow (vph)	0	2736	571	0	1685	742	451	0	400	0	0	0
Turn Type		NA	Free		NA	Free	Prot		Prot			
Protected Phases		2			2		4		4			
Permitted Phases			Free			Free						
Detector Phase		2			2		4		4			
Switch Phase												
Minimum Initial (s)		20.0			20.0		5.0		5.0			
Minimum Split (s)		26.0			26.0		10.5		10.5			
Total Split (s)		85.0			85.0		35.0		35.0			
Total Split (%)		70.8%			70.8%		29.2%		29.2%			
Yellow Time (s)		4.0			4.0		3.5		3.5			
All-Red Time (s)		2.0			2.0		2.0		2.0			
Lost Time Adjust (s)		0.0			0.0		0.0		0.0			
Total Lost Time (s)		6.0			6.0		5.5		5.5			
Lead/Lag												
Lead-Lag Optimize?												
Recall Mode		C-Max			C-Max		None		None			
Act Effct Green (s)		86.5	120.0		86.5	120.0	22.0		22.0			
Actuated g/C Ratio		0.72	1.00		0.72	1.00	0.18		0.18			
v/c Ratio		0.79	0.42		0.71	0.51	0.72		0.75			
Control Delay		13.9	1.0		6.6	2.6	52.4		52.0			
Queue Delay		0.0	0.0		0.1	0.0	0.0		0.2			
Total Delay		13.9	1.0		6.7	2.6	52.4		52.2			
LOS		B	A		A	A	D		D			
Approach Delay		11.7			5.5			52.3				
Approach LOS		B			A			D				
Queue Length 50th (ft)		477	0		119	0	170		156			
Queue Length 95th (ft)		656	0		m146	m434	213		205			
Internal Link Dist (ft)		649			347			213			215	
Turn Bay Length (ft)			500						100			
Base Capacity (vph)		3452	1362		2382	1441	843		705			
Starvation Cap Reductn		0	0		51	0	0		0			
Spillback Cap Reductn		0	0		0	0	0		41			
Storage Cap Reductn		0	0		0	0	0		0			
Reduced v/c Ratio		0.79	0.42		0.72	0.51	0.53		0.60			
Intersection Summary												
Cycle Length: 120												
Actuated Cycle Length: 120												
Offset: 106 (88%), Referenced to phase 2:EBWB, Start of Green												
Natural Cycle: 60												
Control Type: Actuated-Coordinated												

Timings

3: I-25 NB Off-Ramp/I-25 NB On-Ramp & Founders Parkway (SH 86)

Total Traffic Volumes

Year 2023 - PM Peak Hour

Maximum v/c Ratio: 0.79

Intersection Signal Delay: 14.6

Intersection LOS: B

Intersection Capacity Utilization 74.3%

ICU Level of Service D

Analysis Period (min) 15























m Volume for 95th percentile queue is metered by upstream signal.

Splits and Phases: 3: I-25 NB Off-Ramp/I-25 NB On-Ramp & Founders Parkway (SH 86)

  Ø2 (R)	  Ø4
85 s	35 s

Timings
4: Allen Way & Allen Street

Total Traffic Volumes
Year 2023 - PM Peak Hour

												
Lane Group	EBL	EBT	EBR	WBL	WBT	WBR	NBL	NBT	NBR	SBL	SBT	SBR
Lane Configurations												
Traffic Volume (vph)	2	63	88	165	25	47	150	324	100	19	355	10
Future Volume (vph)	2	63	88	165	25	47	150	324	100	19	355	10
Satd. Flow (prot)	1770	1699	0	1770	1863	1583	1770	3539	1583	0	3514	0
Flt Permitted	0.543			0.653			0.507				0.930	
Satd. Flow (perm)	1011	1699	0	1216	1863	1583	944	3539	1583	0	3278	0
Satd. Flow (RTOR)		96				218			218		6	
Lane Group Flow (vph)	2	164	0	179	27	51	163	352	109	0	418	0
Turn Type	pm+pt	NA		Perm	NA	Perm	Perm	NA	Perm	D.P+P	NA	
Protected Phases	3	8			4			6		5	2	
Permitted Phases	8			4		4	6		6	6		
Detector Phase	3	8		4	4	4	6	6	6	5	2	
Switch Phase												
Minimum Initial (s)	3.0	5.0		5.0	5.0	5.0	5.0	5.0	5.0	3.0	5.0	
Minimum Split (s)	8.0	10.0		10.0	10.0	10.0	10.0	10.0	10.0	8.0	10.0	
Total Split (s)	12.0	27.0		15.0	15.0	15.0	21.0	21.0	21.0	12.0	33.0	
Total Split (%)	20.0%	45.0%		25.0%	25.0%	25.0%	35.0%	35.0%	35.0%	20.0%	55.0%	
Yellow Time (s)	3.0	3.0		3.0	3.0	3.0	3.0	3.0	3.0	3.0	3.0	
All-Red Time (s)	2.0	2.0		2.0	2.0	2.0	2.0	2.0	2.0	2.0	2.0	
Lost Time Adjust (s)	0.0	0.0		0.0	0.0	0.0	0.0	0.0	0.0		0.0	
Total Lost Time (s)	5.0	5.0		5.0	5.0	5.0	5.0	5.0	5.0		5.0	
Lead/Lag	Lead			Lag	Lag	Lag	Lag	Lag	Lag	Lead		
Lead-Lag Optimize?	Yes			Yes	Yes	Yes	Yes	Yes	Yes	Yes		
Recall Mode	None	None		None	None	None	C-Min	C-Min	C-Min	None	C-Min	
Act Effct Green (s)	16.0	16.0		13.8	13.8	13.8	34.0	34.0	34.0		34.0	
Actuated g/C Ratio	0.27	0.27		0.23	0.23	0.23	0.57	0.57	0.57		0.57	
v/c Ratio	0.01	0.31		0.64	0.06	0.10	0.31	0.18	0.11		0.22	
Control Delay	13.5	9.0		35.1	18.6	0.4	17.4	11.9	5.1		7.6	
Queue Delay	0.0	0.0		0.0	0.0	0.0	0.0	0.0	0.0		0.0	
Total Delay	13.5	9.0		35.1	18.6	0.4	17.4	11.9	5.1		7.6	
LOS	B	A		D	B	A	B	B	A		A	
Approach Delay		9.0			26.5			12.2			7.6	
Approach LOS		A			C			B			A	
Queue Length 50th (ft)	1	19		55	7	0	78	86	18		34	
Queue Length 95th (ft)	4	50		#156	26	0	m84	m76	m8		70	
Internal Link Dist (ft)		422			420			368			300	
Turn Bay Length (ft)	60			95		65	70		95			
Base Capacity (vph)	358	683		280	429	532	534	2005	991		1860	
Starvation Cap Reductn	0	0		0	0	0	0	0	0		0	
Spillback Cap Reductn	0	0		0	0	0	0	0	0		0	
Storage Cap Reductn	0	0		0	0	0	0	0	0		0	
Reduced v/c Ratio	0.01	0.24		0.64	0.06	0.10	0.31	0.18	0.11		0.22	

Intersection Summary

Cycle Length: 60
 Actuated Cycle Length: 60
 Offset: 31 (52%), Referenced to phase 2:SBT and 6:NBSB, Start of Green
 Natural Cycle: 60
 Control Type: Actuated-Coordinated

Timings
 4: Allen Way & Allen Street

Total Traffic Volumes
 Year 2023 - PM Peak Hour

Maximum v/c Ratio: 0.64
 Intersection Signal Delay: 13.0 Intersection LOS: B
 Intersection Capacity Utilization 54.2% ICU Level of Service A
 Analysis Period (min) 15
 # 95th percentile volume exceeds capacity, queue may be longer.
 Queue shown is maximum after two cycles.
 m Volume for 95th percentile queue is metered by upstream signal.

Splits and Phases: 4: Allen Way & Allen Street

↓ Ø2 (R)	↑	↗ Ø3	← Ø4
33 s	12 s	15 s	
↘ Ø5	↓	↖ Ø8	
12 s	21 s	27 s	
	↑ Ø6 (R)		

HCM 6th TWSC
5: Allen Street & Alexander Place

Total Traffic Volumes
Year 2023 - PM Peak Hour

Intersection												
Int Delay, s/veh	7.2											
Movement	EBL	EBT	EBR	WBL	WBT	WBR	NBL	NBT	NBR	SBL	SBT	SBR
Lane Configurations		↕↔		↕	↔		↕	↕	↕	↕	↕	↕
Traffic Vol, veh/h	59	14	53	98	9	75	58	106	108	64	101	17
Future Vol, veh/h	59	14	53	98	9	75	58	106	108	64	101	17
Conflicting Peds, #/hr	0	0	0	0	0	0	0	0	0	0	0	0
Sign Control	Stop	Stop	Stop	Stop	Stop	Stop	Free	Free	Free	Free	Free	Free
RT Channelized	-	-	None	-	-	None	-	-	None	-	-	None
Storage Length	-	-	-	60	-	-	75	-	75	80	-	-
Veh in Median Storage, #	-	0	-	-	0	-	-	0	-	-	0	-
Grade, %	-	0	-	-	0	-	-	0	-	-	0	-
Peak Hour Factor	92	92	92	92	92	92	92	92	92	92	92	92
Heavy Vehicles, %	2	2	2	2	2	2	2	2	2	2	2	2
Mvmt Flow	64	15	58	107	10	82	63	115	117	70	110	18

Major/Minor	Minor2		Minor1		Major1		Major2					
Conflicting Flow All	605	617	119	537	509	115	128	0	0	232	0	0
Stage 1	259	259	-	241	241	-	-	-	-	-	-	-
Stage 2	346	358	-	296	268	-	-	-	-	-	-	-
Critical Hdwy	7.12	6.52	6.22	7.12	6.52	6.22	4.12	-	-	4.12	-	-
Critical Hdwy Stg 1	6.12	5.52	-	6.12	5.52	-	-	-	-	-	-	-
Critical Hdwy Stg 2	6.12	5.52	-	6.12	5.52	-	-	-	-	-	-	-
Follow-up Hdwy	3.518	4.018	3.318	3.518	4.018	3.318	2.218	-	-	2.218	-	-
Pot Cap-1 Maneuver	410	405	933	455	467	937	1458	-	-	1336	-	-
Stage 1	746	694	-	762	706	-	-	-	-	-	-	-
Stage 2	670	628	-	712	687	-	-	-	-	-	-	-
Platoon blocked, %								-	-	-	-	-
Mov Cap-1 Maneuver	342	367	933	384	424	937	1458	-	-	1336	-	-
Mov Cap-2 Maneuver	342	367	-	384	424	-	-	-	-	-	-	-
Stage 1	714	658	-	729	676	-	-	-	-	-	-	-
Stage 2	577	601	-	618	651	-	-	-	-	-	-	-

Approach	EB		WB		NB		SB	
HCM Control Delay, s	15.7		14.2		1.6		2.8	
HCM LOS	C		B					

Minor Lane/Major Mvmt	NBL	NBT	NBR	EBLn1	WBLn1	WBLn2	SBL	SBT	SBR
Capacity (veh/h)	1458	-	-	471	384	829	1336	-	-
HCM Lane V/C Ratio	0.043	-	-	0.291	0.277	0.11	0.052	-	-
HCM Control Delay (s)	7.6	-	-	15.7	17.9	9.9	7.8	-	-
HCM Lane LOS	A	-	-	C	C	A	A	-	-
HCM 95th %tile Q(veh)	0.1	-	-	1.2	1.1	0.4	0.2	-	-

HCM 6th AWSC
6: Allen Street & Front Street

Total Traffic Volumes
Year 2023 - PM Peak Hour

Intersection	
Intersection Delay, s/veh	10.7
Intersection LOS	B

Movement	EBL	EBR	NBL	NBT	SBT	SBR
Lane Configurations	↙	↗	↙	↑	↑	↗
Traffic Vol, veh/h	178	130	81	157	154	119
Future Vol, veh/h	178	130	81	157	154	119
Peak Hour Factor	0.92	0.92	0.92	0.92	0.92	0.92
Heavy Vehicles, %	2	2	2	2	2	2
Mvmt Flow	193	141	88	171	167	129
Number of Lanes	1	1	1	1	1	1

Approach	EB	NB	SB
Opposing Approach		SB	NB
Opposing Lanes	0	2	2
Conflicting Approach Left	SB	EB	
Conflicting Lanes Left	2	2	0
Conflicting Approach Right	NB		EB
Conflicting Lanes Right	2	0	2
HCM Control Delay	11.3	10.7	10.1
HCM LOS	B	B	B

Lane	NBLn1	NBLn2	EBLn1	EBLn2	SBLn1	SBLn2
Vol Left, %	100%	0%	100%	0%	0%	0%
Vol Thru, %	0%	100%	0%	0%	100%	0%
Vol Right, %	0%	0%	0%	100%	0%	100%
Sign Control	Stop	Stop	Stop	Stop	Stop	Stop
Traffic Vol by Lane	81	157	178	130	154	119
LT Vol	81	0	178	0	0	0
Through Vol	0	157	0	0	154	0
RT Vol	0	0	0	130	0	119
Lane Flow Rate	88	171	193	141	167	129
Geometry Grp	7	7	7	7	7	7
Degree of Util (X)	0.157	0.28	0.35	0.208	0.274	0.186
Departure Headway (Hd)	6.416	5.909	6.505	5.295	5.891	5.181
Convergence, Y/N	Yes	Yes	Yes	Yes	Yes	Yes
Cap	560	609	553	678	611	693
Service Time	4.145	3.638	4.229	3.019	3.619	2.91
HCM Lane V/C Ratio	0.157	0.281	0.349	0.208	0.273	0.186
HCM Control Delay	10.3	10.9	12.7	9.4	10.8	9.1
HCM Lane LOS	B	B	B	A	B	A
HCM 95th-tile Q	0.6	1.1	1.6	0.8	1.1	0.7

HCM 6th TWSC
7: Private Access/Brewer Court & Alexander Place

Total Traffic Volumes
Year 2023 - PM Peak Hour

Intersection												
Int Delay, s/veh	7.4											
Movement	EBL	EBT	EBR	WBL	WBT	WBR	NBL	NBT	NBR	SBL	SBT	SBR
Lane Configurations	↕			↕			↕			↕		
Traffic Vol, veh/h	143	27	7	0	25	0	20	2	0	0	2	147
Future Vol, veh/h	143	27	7	0	25	0	20	2	0	0	2	147
Conflicting Peds, #/hr	0	0	0	0	0	0	0	0	0	0	0	0
Sign Control	Free	Free	Free	Free	Free	Free	Stop	Stop	Stop	Stop	Stop	Stop
RT Channelized	-	-	None	-	-	None	-	-	None	-	-	None
Storage Length	-	-	-	-	-	-	-	-	-	-	-	-
Veh in Median Storage, #	-	0	-	-	0	-	-	0	-	-	0	-
Grade, %	-	0	-	-	0	-	-	0	-	-	0	-
Peak Hour Factor	92	92	92	92	92	92	92	92	92	92	92	92
Heavy Vehicles, %	2	2	2	2	2	2	2	2	2	2	2	2
Mvmt Flow	155	29	8	0	27	0	22	2	0	0	2	160

Major/Minor	Major1		Major2		Minor1		Minor2					
Conflicting Flow All	27	0	0	37	0	0	451	370	33	371	374	27
Stage 1	-	-	-	-	-	-	343	343	-	27	27	-
Stage 2	-	-	-	-	-	-	108	27	-	344	347	-
Critical Hdwy	4.12	-	-	4.12	-	-	7.12	6.52	6.22	7.12	6.52	6.22
Critical Hdwy Stg 1	-	-	-	-	-	-	6.12	5.52	-	6.12	5.52	-
Critical Hdwy Stg 2	-	-	-	-	-	-	6.12	5.52	-	6.12	5.52	-
Follow-up Hdwy	2.218	-	-	2.218	-	-	3.518	4.018	3.318	3.518	4.018	3.318
Pot Cap-1 Maneuver	1587	-	-	1574	-	-	519	560	1041	586	557	1048
Stage 1	-	-	-	-	-	-	672	637	-	990	873	-
Stage 2	-	-	-	-	-	-	897	873	-	671	635	-
Platoon blocked, %	-	-	-	-	-	-	-	-	-	-	-	-
Mov Cap-1 Maneuver	1587	-	-	1574	-	-	405	504	1041	539	501	1048
Mov Cap-2 Maneuver	-	-	-	-	-	-	405	504	-	539	501	-
Stage 1	-	-	-	-	-	-	605	573	-	891	873	-
Stage 2	-	-	-	-	-	-	758	873	-	602	572	-

Approach	EB	WB	NB	SB
HCM Control Delay, s	6.1	0	14.3	9.1
HCM LOS			B	A

Minor Lane/Major Mvmt	NBLn1	EBL	EBT	EBR	WBL	WBT	WBR	SBLn1
Capacity (veh/h)	412	1587	-	-	1574	-	-	1033
HCM Lane V/C Ratio	0.058	0.098	-	-	-	-	-	0.157
HCM Control Delay (s)	14.3	7.5	0	-	0	-	-	9.1
HCM Lane LOS	B	A	A	-	A	-	-	A
HCM 95th %tile Q(veh)	0.2	0.3	-	-	0	-	-	0.6

Timings
1: Front Street & Founders Parkway (SH 86)

Total Traffic Volumes
Year 2023 - Saturday Peak Hour

Lane Group	EBL	EBT	EBR	WBL	WBT	WBR	NBL	NBT	NBR	SBL	SBT	SBR
Lane Configurations												
Traffic Volume (vph)	348	113	145	47	123	93	114	1554	41	160	1419	394
Future Volume (vph)	348	113	145	47	123	93	114	1554	41	160	1419	394
Satd. Flow (prot)	3433	1863	1583	1770	3313	0	1770	5065	0	1770	4917	0
Flt Permitted	0.483			0.678			0.084			0.080		
Satd. Flow (perm)	1745	1863	1583	1263	3313	0	156	5065	0	149	4917	0
Satd. Flow (RTOR)			196		101			5			98	
Lane Group Flow (vph)	378	123	158	51	235	0	124	1734	0	174	1970	0
Turn Type	pm+pt	NA	Perm	pm+pt	NA		pm+pt	NA		pm+pt	NA	
Protected Phases	7	4		3	8		1	6		5	2	
Permitted Phases	4		4	8			6			2		
Detector Phase	7	4	4	3	8		1	6		5	2	
Switch Phase												
Minimum Initial (s)	3.0	5.0	5.0	3.0	5.0		3.0	20.0		3.0	20.0	
Minimum Split (s)	10.0	11.0	11.0	10.0	11.0		10.0	26.0		10.0	26.0	
Total Split (s)	14.0	13.0	13.0	20.0	19.0		12.0	52.0		15.0	55.0	
Total Split (%)	14.0%	13.0%	13.0%	20.0%	19.0%		12.0%	52.0%		15.0%	55.0%	
Yellow Time (s)	3.0	4.0	4.0	3.0	4.0		3.0	4.0		3.0	4.0	
All-Red Time (s)	2.0	2.0	2.0	2.0	2.0		2.0	2.0		2.0	2.0	
Lost Time Adjust (s)	0.0	0.0	0.0	0.0	0.0		0.0	0.0		0.0	0.0	
Total Lost Time (s)	5.0	6.0	6.0	5.0	6.0		5.0	6.0		5.0	6.0	
Lead/Lag	Lead	Lag	Lag	Lead	Lag		Lead	Lag		Lead	Lag	
Lead-Lag Optimize?	Yes	Yes	Yes	Yes	Yes		Yes	Yes		Yes	Yes	
Recall Mode	None	None	None	None	None		None	C-Max		None	C-Max	
Act Effct Green (s)	22.5	14.3	14.3	19.5	10.8		57.0	48.9		61.4	51.1	
Actuated g/C Ratio	0.22	0.14	0.14	0.20	0.11		0.57	0.49		0.61	0.51	
v/c Ratio	0.70	0.46	0.40	0.18	0.52		0.61	0.70		0.72	0.77	
Control Delay	38.9	46.7	6.1	29.0	27.6		28.5	22.3		35.4	21.6	
Queue Delay	0.0	0.0	0.0	0.0	0.0		0.0	0.0		0.0	0.0	
Total Delay	38.9	46.7	6.1	29.0	27.6		28.5	22.3		35.4	21.6	
LOS	D	D	A	C	C		C	C		D	C	
Approach Delay		32.5			27.8			22.7			22.7	
Approach LOS		C			C			C			C	
Queue Length 50th (ft)	101	74	0	24	41		29	321		54	354	
Queue Length 95th (ft)	142	134	34	53	78		#99	379		#147	420	
Internal Link Dist (ft)		695			413			423			624	
Turn Bay Length (ft)	285		285	195			175			455		
Base Capacity (vph)	543	265	394	402	518		205	2479		257	2560	
Starvation Cap Reductn	0	0	0	0	0		0	0		0	0	
Spillback Cap Reductn	0	0	0	0	0		0	0		0	0	
Storage Cap Reductn	0	0	0	0	0		0	0		0	0	
Reduced v/c Ratio	0.70	0.46	0.40	0.13	0.45		0.60	0.70		0.68	0.77	

Intersection Summary









Cycle Length: 100
 Actuated Cycle Length: 100
 Offset: 62 (62%), Referenced to phase 2:SBTL and 6:NBTL, Start of Green
 Natural Cycle: 60
 Control Type: Actuated-Coordinated

Timings
 1: Front Street & Founders Parkway (SH 86)

Total Traffic Volumes
 Year 2023 - Saturday Peak Hour

Maximum v/c Ratio: 0.77
 Intersection Signal Delay: 24.3 Intersection LOS: C
 Intersection Capacity Utilization 77.2% ICU Level of Service D
 Analysis Period (min) 15
 # 95th percentile volume exceeds capacity, queue may be longer.
 Queue shown is maximum after two cycles.

Splits and Phases: 1: Front Street & Founders Parkway (SH 86)

 Ø1	 Ø2 (R)	 Ø3	 Ø4
12 s	55 s	20 s	13 s
 Ø5	 Ø6 (R)	 Ø7	 Ø8
15 s	52 s	14 s	19 s

Timings
2: Allen Way & Founders Parkway (SH 86)

Total Traffic Volumes
Year 2023 - Saturday Peak Hour

Lane Group	EBL	EBT	EBR	WBL	WBT	WBR	NBL	NBT	NBR	SBL	SBT	SBR
Lane Configurations												
Traffic Volume (vph)	487	1744	226	45	1738	202	189	38	90	140	41	528
Future Volume (vph)	487	1744	226	45	1738	202	189	38	90	140	41	528
Satd. Flow (prot)	3433	4999	0	1770	5085	1583	1770	1665	0	1770	1863	2787
Flt Permitted	0.950			0.101			0.634			0.598		
Satd. Flow (perm)	3433	4999	0	188	5085	1583	1181	1665	0	1114	1863	2787
Satd. Flow (RTOR)		34				220		93				535
Lane Group Flow (vph)	529	2142	0	49	1889	220	205	139	0	152	45	574
Turn Type	Prot	NA		pm+pt	NA	Perm	pm+pt	NA		pm+pt	NA	Perm
Protected Phases	5	2		1	6		7	4		3	8	
Permitted Phases				6		6	4			8		8
Detector Phase	5	2		1	6	6	7	4		3	8	8
Switch Phase												
Minimum Initial (s)	5.0	20.0		5.0	20.0	20.0	5.0	5.0		5.0	5.0	5.0
Minimum Split (s)	10.0	26.0		10.0	26.0	26.0	10.0	11.0		11.0	11.0	11.0
Total Split (s)	20.0	58.0		11.0	49.0	49.0	18.0	13.0		18.0	13.0	13.0
Total Split (%)	20.0%	58.0%		11.0%	49.0%	49.0%	18.0%	13.0%		18.0%	13.0%	13.0%
Yellow Time (s)	3.0	4.0		3.0	4.0	4.0	3.0	4.0		3.0	4.0	4.0
All-Red Time (s)	2.0	2.0		2.0	2.0	2.0	2.0	2.0		2.0	2.0	2.0
Lost Time Adjust (s)	0.0	0.0		0.0	0.0	0.0	0.0	0.0		0.0	0.0	0.0
Total Lost Time (s)	5.0	6.0		5.0	6.0	6.0	5.0	6.0		5.0	6.0	6.0
Lead/Lag	Lead	Lead		Lag	Lag	Lag	Lead	Lag		Lead	Lag	Lag
Lead-Lag Optimize?	Yes	Yes		Yes	Yes	Yes	Yes	Yes		Yes	Yes	Yes
Recall Mode	None	C-Min		None	C-Min	C-Min	None	None		None	None	None
Act Effct Green (s)	16.5	57.2		43.3	42.3	42.3	21.2	7.8		19.2	6.8	6.8
Actuated g/C Ratio	0.16	0.57		0.43	0.42	0.42	0.21	0.08		0.19	0.07	0.07
v/c Ratio	0.93	0.75		0.28	0.88	0.28	0.64	0.65		0.53	0.36	0.84
Control Delay	63.3	20.9		30.2	32.1	3.4	41.6	32.7		37.7	52.8	17.9
Queue Delay	0.0	1.9		0.0	10.3	0.0	0.0	0.0		0.0	0.0	1.3
Total Delay	63.3	22.8		30.2	42.5	3.4	41.6	32.7		37.7	52.8	19.2
LOS	E	C		C	D	A	D	C		D	D	B
Approach Delay		30.8			38.2			38.0			24.8	
Approach LOS		C			D			D			C	
Queue Length 50th (ft)	~187	368		17	390	0	109	28		79	28	13
Queue Length 95th (ft)	#294	464		39	459	41	178	#112		136	64	#94
Internal Link Dist (ft)		347			406			277			368	
Turn Bay Length (ft)	300			330			80			120		100
Base Capacity (vph)	566	2875		176	2186	806	333	215		316	130	692
Starvation Cap Reductn	0	539		0	0	0	0	0		0	0	0
Spillback Cap Reductn	0	0		0	301	0	0	0		0	0	31
Storage Cap Reductn	0	0		0	0	0	0	0		0	0	0
Reduced v/c Ratio	0.93	0.92		0.28	1.00	0.27	0.62	0.65		0.48	0.35	0.87

Intersection Summary

Cycle Length: 100
 Actuated Cycle Length: 100
 Offset: 70 (70%), Referenced to phase 2:EBT and 6:WBTL, Start of Green
 Natural Cycle: 80
 Control Type: Actuated-Coordinated

Timings
 2: Allen Way & Founders Parkway (SH 86)

Total Traffic Volumes
 Year 2023 - Saturday Peak Hour

Maximum v/c Ratio: 0.93

Intersection Signal Delay: 33.1

Intersection LOS: C

Intersection Capacity Utilization 81.1%

ICU Level of Service D

Analysis Period (min) 15

~ Volume exceeds capacity, queue is theoretically infinite.

Queue shown is maximum after two cycles.

95th percentile volume exceeds capacity, queue may be longer.

Queue shown is maximum after two cycles.

Splits and Phases: 2: Allen Way & Founders Parkway (SH 86)



















→ Ø2 (R) 58 s	↓	↙ Ø1 11 s	↘ Ø3 18 s	↕ Ø4 13 s
↗ Ø5 20 s	↖ Ø6 (R) 49 s	↙ Ø7 18 s	↘ Ø8 13 s	

Timings

3: I-25 NB Off-Ramp/I-25 NB On-Ramp & Founders Parkway (SH 86)

Total Traffic Volumes

Year 2023 - Saturday Peak Hour

												
Lane Group	EBL	EBT	EBR	WBL	WBT	WBR	NBL	NBT	NBR	SBL	SBT	SBR
Lane Configurations												
Traffic Volume (vph)	0	2061	517	0	1393	1065	532	0	400	0	0	0
Future Volume (vph)	0	2061	517	0	1393	1065	532	0	400	0	0	0
Satd. Flow (prot)	0	4787	1362	0	3295	1441	3433	0	2787	0	0	0
Flt Permitted							0.950					
Satd. Flow (perm)	0	4787	1362	0	3295	1441	3433	0	2787	0	0	0
Satd. Flow (RTOR)		6	459		49	475			33			
Lane Group Flow (vph)	0	2296	506	0	1861	811	578	0	435	0	0	0
Turn Type		NA	Free		NA	Free	Prot		Prot			
Protected Phases		2			2		4		4			
Permitted Phases			Free			Free						
Detector Phase		2			2		4		4			
Switch Phase												
Minimum Initial (s)		20.0			20.0		5.0		5.0			
Minimum Split (s)		26.0			26.0		10.5		10.5			
Total Split (s)		68.0			68.0		32.0		32.0			
Total Split (%)		68.0%			68.0%		32.0%		32.0%			
Yellow Time (s)		4.0			4.0		3.5		3.5			
All-Red Time (s)		2.0			2.0		2.0		2.0			
Lost Time Adjust (s)		0.0			0.0		0.0		0.0			
Total Lost Time (s)		6.0			6.0		5.5		5.5			
Lead/Lag												
Lead-Lag Optimize?												
Recall Mode		C-Max			C-Max		None		None			
Act Effct Green (s)		66.2	100.0		66.2	100.0	22.3		22.3			
Actuated g/C Ratio		0.66	1.00		0.66	1.00	0.22		0.22			
v/c Ratio		0.72	0.37		0.85	0.56	0.75		0.67			
Control Delay		13.2	0.8		11.0	3.8	42.7		37.8			
Queue Delay		0.1	0.0		34.7	0.0	0.0		56.5			
Total Delay		13.3	0.8		45.7	3.8	42.7		94.3			
LOS		B	A		D	A	D		F			
Approach Delay		11.1			33.0			64.9				
Approach LOS		B			C			E				
Queue Length 50th (ft)		335	0		611	231	177		132			
Queue Length 95th (ft)		447	0		742	m357	225		181			
Internal Link Dist (ft)		649			347			213			215	
Turn Bay Length (ft)			500						100			
Base Capacity (vph)		3170	1362		2197	1441	909		762			
Starvation Cap Reductn		0	0		459	0	0		0			
Spillback Cap Reductn		126	0		0	0	0		389			
Storage Cap Reductn		0	0		0	0	0		0			
Reduced v/c Ratio		0.75	0.37		1.07	0.56	0.64		1.17			
Intersection Summary												
Cycle Length: 100												
Actuated Cycle Length: 100												
Offset: 80 (80%), Referenced to phase 2:EBWB, Start of Green												
Natural Cycle: 65												
Control Type: Actuated-Coordinated												

Timings

Total Traffic Volumes

3: I-25 NB Off-Ramp/I-25 NB On-Ramp & Founders Parkway (SH 86)

Year 2023 - Saturday Peak Hour

Maximum v/c Ratio: 0.85

Intersection Signal Delay: 28.5

Intersection LOS: C

Intersection Capacity Utilization 73.3%

ICU Level of Service D

Analysis Period (min) 15























m Volume for 95th percentile queue is metered by upstream signal.

Splits and Phases: 3: I-25 NB Off-Ramp/I-25 NB On-Ramp & Founders Parkway (SH 86)

 Ø2 (R)	 Ø4
68 s	32 s

Timings
4: Allen Way & Allen Street

Total Traffic Volumes
Year 2023 - Saturday Peak Hour

												
Lane Group	EBL	EBT	EBR	WBL	WBT	WBR	NBL	NBT	NBR	SBL	SBT	SBR
Lane Configurations												
Traffic Volume (vph)	10	57	139	151	57	72	159	392	96	59	363	4
Future Volume (vph)	10	57	139	151	57	72	159	392	96	59	363	4
Satd. Flow (prot)	1770	1665	0	1770	1863	1583	1770	3539	1583	0	3511	0
Flt Permitted	0.519			0.625			0.486				0.847	
Satd. Flow (perm)	967	1665	0	1164	1863	1583	905	3539	1583	0	2995	0
Satd. Flow (RTOR)		151				218			218		2	
Lane Group Flow (vph)	11	213	0	164	62	78	173	426	104	0	463	0
Turn Type	pm+pt	NA		Perm	NA	Perm	Perm	NA	Perm	D.P+P	NA	
Protected Phases	3	8			4			6		5	2	
Permitted Phases	8			4		4	6		6	6		
Detector Phase	3	8		4	4	4	6	6	6	5	2	
Switch Phase												
Minimum Initial (s)	3.0	5.0		5.0	5.0	5.0	5.0	5.0	5.0	3.0	5.0	
Minimum Split (s)	8.0	10.0		10.0	10.0	10.0	10.0	10.0	10.0	8.0	10.0	
Total Split (s)	12.0	27.0		15.0	15.0	15.0	21.0	21.0	21.0	12.0	33.0	
Total Split (%)	20.0%	45.0%		25.0%	25.0%	25.0%	35.0%	35.0%	35.0%	20.0%	55.0%	
Yellow Time (s)	3.0	3.0		3.0	3.0	3.0	3.0	3.0	3.0	3.0	3.0	
All-Red Time (s)	2.0	2.0		2.0	2.0	2.0	2.0	2.0	2.0	2.0	2.0	
Lost Time Adjust (s)	0.0	0.0		0.0	0.0	0.0	0.0	0.0	0.0		0.0	
Total Lost Time (s)	5.0	5.0		5.0	5.0	5.0	5.0	5.0	5.0		5.0	
Lead/Lag	Lead			Lag	Lag	Lag	Lag	Lag	Lag	Lead		
Lead-Lag Optimize?	Yes			Yes	Yes	Yes	Yes	Yes	Yes	Yes		
Recall Mode	None	None		None	None	None	C-Min	C-Min	C-Min	None	C-Min	
Act Effct Green (s)	15.4	15.4		13.1	13.1	13.1	34.6	34.6	34.6		34.6	
Actuated g/C Ratio	0.26	0.26		0.22	0.22	0.22	0.58	0.58	0.58		0.58	
v/c Ratio	0.03	0.39		0.65	0.15	0.15	0.33	0.21	0.10		0.27	
Control Delay	14.1	7.8		37.0	19.9	0.6	10.5	7.4	0.2		7.8	
Queue Delay	0.0	0.0		0.0	0.0	0.0	0.0	0.0	0.0		0.0	
Total Delay	14.1	7.8		37.0	19.9	0.6	10.5	7.4	0.2		7.8	
LOS	B	A		D	B	A	B	A	A		A	
Approach Delay		8.1			24.2			7.1			7.8	
Approach LOS		A			C			A			A	
Queue Length 50th (ft)	3	17		51	17	0	29	34	0		38	
Queue Length 95th (ft)	11	53		#149	48	0	84	71	0		80	
Internal Link Dist (ft)		422			420			368			300	
Turn Bay Length (ft)	60			95		65	70		95			
Base Capacity (vph)	342	706		256	410	518	521	2039	1005		1726	
Starvation Cap Reductn	0	0		0	0	0	0	0	0		0	
Spillback Cap Reductn	0	0		0	0	0	0	0	0		0	
Storage Cap Reductn	0	0		0	0	0	0	0	0		0	
Reduced v/c Ratio	0.03	0.30		0.64	0.15	0.15	0.33	0.21	0.10		0.27	

Intersection Summary

Cycle Length: 60
 Actuated Cycle Length: 60
 Offset: 31 (52%), Referenced to phase 2:SBT and 6:NBSB, Start of Green
 Natural Cycle: 60
 Control Type: Actuated-Coordinated

Timings
4: Allen Way & Allen Street

Total Traffic Volumes
Year 2023 - Saturday Peak Hour

Maximum v/c Ratio: 0.65

Intersection Signal Delay: 10.5

Intersection LOS: B

Intersection Capacity Utilization 59.3%

ICU Level of Service B

Analysis Period (min) 15

95th percentile volume exceeds capacity, queue may be longer.

Queue shown is maximum after two cycles.

Splits and Phases: 4: Allen Way & Allen Street

↓ Ø2 (R)	↑ Ø6 (R)	↘ Ø3	← Ø4
33 s	21 s	12 s	15 s
↙ Ø5	↓ Ø6 (R)	↗ Ø8	
12 s	21 s	27 s	

HCM 6th TWSC
5: Allen Street & Alexander Place

Total Traffic Volumes
Year 2023 - Saturday Peak Hour

Intersection												
Int Delay, s/veh	8.4											
Movement	EBL	EBT	EBR	WBL	WBT	WBR	NBL	NBT	NBR	SBL	SBT	SBR
Lane Configurations		↕		↕	↕		↕	↕	↕	↕	↕	↕
Traffic Vol, veh/h	77	6	49	141	8	60	58	136	117	66	135	27
Future Vol, veh/h	77	6	49	141	8	60	58	136	117	66	135	27
Conflicting Peds, #/hr	0	0	0	0	0	0	0	0	0	0	0	0
Sign Control	Stop	Stop	Stop	Stop	Stop	Stop	Free	Free	Free	Free	Free	Free
RT Channelized	-	-	None	-	-	None	-	-	None	-	-	None
Storage Length	-	-	-	60	-	-	75	-	75	80	-	-
Veh in Median Storage, #	-	0	-	-	0	-	-	0	-	-	0	-
Grade, %	-	0	-	-	0	-	-	0	-	-	0	-
Peak Hour Factor	92	92	92	92	92	92	92	92	92	92	92	92
Heavy Vehicles, %	2	2	2	2	2	2	2	2	2	2	2	2
Mvmt Flow	84	7	53	153	9	65	63	148	127	72	147	29

Major/Minor	Minor2		Minor1		Major1		Major2					
Conflicting Flow All	681	707	162	610	594	148	176	0	0	275	0	0
Stage 1	306	306	-	274	274	-	-	-	-	-	-	-
Stage 2	375	401	-	336	320	-	-	-	-	-	-	-
Critical Hdwy	7.12	6.52	6.22	7.12	6.52	6.22	4.12	-	-	4.12	-	-
Critical Hdwy Stg 1	6.12	5.52	-	6.12	5.52	-	-	-	-	-	-	-
Critical Hdwy Stg 2	6.12	5.52	-	6.12	5.52	-	-	-	-	-	-	-
Follow-up Hdwy	3.518	4.018	3.318	3.518	4.018	3.318	2.218	-	-	2.218	-	-
Pot Cap-1 Maneuver	364	360	883	407	418	899	1400	-	-	1288	-	-
Stage 1	704	662	-	732	683	-	-	-	-	-	-	-
Stage 2	646	601	-	678	652	-	-	-	-	-	-	-
Platoon blocked, %								-	-	-	-	-
Mov Cap-1 Maneuver	307	325	883	348	377	899	1400	-	-	1288	-	-
Mov Cap-2 Maneuver	307	325	-	348	377	-	-	-	-	-	-	-
Stage 1	672	625	-	699	652	-	-	-	-	-	-	-
Stage 2	565	574	-	595	615	-	-	-	-	-	-	-

Approach	EB		WB		NB		SB	
HCM Control Delay, s	18.6		18.9		1.4		2.3	
HCM LOS	C		C					

Minor Lane/Major Mvmt	NBL	NBT	NBR	EBLn1	WBLn1	WBLn2	SBL	SBT	SBR
Capacity (veh/h)	1400	-	-	406	348	773	1288	-	-
HCM Lane V/C Ratio	0.045	-	-	0.353	0.44	0.096	0.056	-	-
HCM Control Delay (s)	7.7	-	-	18.6	23.2	10.1	8	-	-
HCM Lane LOS	A	-	-	C	C	B	A	-	-
HCM 95th %tile Q(veh)	0.1	-	-	1.6	2.2	0.3	0.2	-	-

HCM 6th AWSC
6: Allen Street & Front Street

Total Traffic Volumes
Year 2023 - Saturday Peak Hour

Intersection	
Intersection Delay, s/veh	11.7
Intersection LOS	B

Movement	EBL	EBR	NBL	NBT	SBT	SBR
Lane Configurations	↙	↗	↙	↗	↗	↗
Traffic Vol, veh/h	209	99	83	181	173	185
Future Vol, veh/h	209	99	83	181	173	185
Peak Hour Factor	0.92	0.92	0.92	0.92	0.92	0.92
Heavy Vehicles, %	2	2	2	2	2	2
Mvmt Flow	227	108	90	197	188	201
Number of Lanes	1	1	1	1	1	1

Approach	EB	NB	SB
Opposing Approach		SB	NB
Opposing Lanes	0	2	2
Conflicting Approach Left	SB	EB	
Conflicting Lanes Left	2	2	0
Conflicting Approach Right	NB		EB
Conflicting Lanes Right	2	0	2
HCM Control Delay	12.9	11.5	10.9
HCM LOS	B	B	B

Lane	NBLn1	NBLn2	EBLn1	EBLn2	SBLn1	SBLn2
Vol Left, %	100%	0%	100%	0%	0%	0%
Vol Thru, %	0%	100%	0%	0%	100%	0%
Vol Right, %	0%	0%	0%	100%	0%	100%
Sign Control	Stop	Stop	Stop	Stop	Stop	Stop
Traffic Vol by Lane	83	181	209	99	173	185
LT Vol	83	0	209	0	0	0
Through Vol	0	181	0	0	173	0
RT Vol	0	0	0	99	0	185
Lane Flow Rate	90	197	227	108	188	201
Geometry Grp	7	7	7	7	7	7
Degree of Util (X)	0.166	0.334	0.428	0.167	0.315	0.297
Departure Headway (Hd)	6.62	6.112	6.786	5.574	6.022	5.312
Convergence, Y/N	Yes	Yes	Yes	Yes	Yes	Yes
Cap	542	588	532	644	598	676
Service Time	4.36	3.852	4.523	3.311	3.758	3.047
HCM Lane V/C Ratio	0.166	0.335	0.427	0.168	0.314	0.297
HCM Control Delay	10.7	11.9	14.5	9.4	11.5	10.3
HCM Lane LOS	B	B	B	A	B	B
HCM 95th-tile Q	0.6	1.5	2.1	0.6	1.3	1.2

HCM 6th TWSC
7: Private Access/Brewer Court & Alexander Place

Total Traffic Volumes
Year 2023 - Saturday Peak Hour

Intersection												
Int Delay, s/veh	7.3											
Movement	EBL	EBT	EBR	WBL	WBT	WBR	NBL	NBT	NBR	SBL	SBT	SBR
Lane Configurations	↕			↕			↕			↕		
Traffic Vol, veh/h	169	24	4	0	36	0	3	0	0	0	0	188
Future Vol, veh/h	169	24	4	0	36	0	3	0	0	0	0	188
Conflicting Peds, #/hr	0	0	0	0	0	0	0	0	0	0	0	0
Sign Control	Free	Free	Free	Free	Free	Free	Stop	Stop	Stop	Stop	Stop	Stop
RT Channelized	-	-	None	-	-	None	-	-	None	-	-	None
Storage Length	-	-	-	-	-	-	-	-	-	-	-	-
Veh in Median Storage, #	-	0	-	-	0	-	-	0	-	-	0	-
Grade, %	-	0	-	-	0	-	-	0	-	-	0	-
Peak Hour Factor	92	92	92	92	92	92	92	92	92	92	92	92
Heavy Vehicles, %	2	2	2	2	2	2	2	2	2	2	2	2
Mvmt Flow	184	26	4	0	39	0	3	0	0	0	0	204

Major/Minor	Major1			Major2			Minor1			Minor2		
Conflicting Flow All	39	0	0	30	0	0	537	435	28	435	437	39
Stage 1	-	-	-	-	-	-	396	396	-	39	39	-
Stage 2	-	-	-	-	-	-	141	39	-	396	398	-
Critical Hdwy	4.12	-	-	4.12	-	-	7.12	6.52	6.22	7.12	6.52	6.22
Critical Hdwy Stg 1	-	-	-	-	-	-	6.12	5.52	-	6.12	5.52	-
Critical Hdwy Stg 2	-	-	-	-	-	-	6.12	5.52	-	6.12	5.52	-
Follow-up Hdwy	2.218	-	-	2.218	-	-	3.518	4.018	3.318	3.518	4.018	3.318
Pot Cap-1 Maneuver	1571	-	-	1583	-	-	455	514	1047	531	513	1033
Stage 1	-	-	-	-	-	-	629	604	-	976	862	-
Stage 2	-	-	-	-	-	-	862	862	-	629	603	-
Platoon blocked, %	-	-	-	-	-	-	-	-	-	-	-	-
Mov Cap-1 Maneuver	1571	-	-	1583	-	-	332	453	1047	483	452	1033
Mov Cap-2 Maneuver	-	-	-	-	-	-	332	453	-	483	452	-
Stage 1	-	-	-	-	-	-	554	532	-	860	862	-
Stage 2	-	-	-	-	-	-	691	862	-	554	531	-

Approach	EB	WB	NB	SB
HCM Control Delay, s	6.5	0	16	9.3
HCM LOS			C	A

Minor Lane/Major Mvmt	NBLn1	EBL	EBT	EBR	WBL	WBT	WBR	SBLn1
Capacity (veh/h)	332	1571	-	-	1583	-	-	1033
HCM Lane V/C Ratio	0.01	0.117	-	-	-	-	-	0.198
HCM Control Delay (s)	16	7.6	0	-	0	-	-	9.3
HCM Lane LOS	C	A	A	-	A	-	-	A
HCM 95th %tile Q(veh)	0	0.4	-	-	0	-	-	0.7

Timings
1: Front Street & Founders Parkway (SH 86)

Total Traffic Volumes
Year 2041 - AM Peak Hour

Lane Group	EBL	EBT	EBR	WBL	WBT	WBR	NBL	NBT	NBR	SBL	SBT	SBR
Lane Configurations												
Traffic Volume (vph)	255	58	53	26	42	85	84	2179	14	75	1287	237
Future Volume (vph)	255	58	53	26	42	85	84	2179	14	75	1287	237
Satd. Flow (prot)	3433	1863	1583	1770	3185	0	3433	5080	0	1770	5085	1583
Flt Permitted	0.420			0.716			0.151			0.055		
Satd. Flow (perm)	1518	1863	1583	1334	3185	0	546	5080	0	102	5085	1583
Satd. Flow (RTOR)			118		76			1				258
Lane Group Flow (vph)	277	63	58	28	138	0	91	2383	0	82	1399	258
Turn Type	pm+pt	NA	Perm	pm+pt	NA		pm+pt	NA		pm+pt	NA	Perm
Protected Phases	7	4		3	8		1	6		5	2	
Permitted Phases	4		4	8			6			2		2
Detector Phase	7	4	4	3	8		1	6		5	2	2
Switch Phase												
Minimum Initial (s)	3.0	5.0	5.0	3.0	5.0		3.0	20.0		3.0	20.0	20.0
Minimum Split (s)	10.0	11.0	11.0	10.0	11.0		10.0	26.0		10.0	26.0	26.0
Total Split (s)	16.0	19.0	19.0	10.0	13.0		10.0	77.0		14.0	81.0	81.0
Total Split (%)	13.3%	15.8%	15.8%	8.3%	10.8%		8.3%	64.2%		11.7%	67.5%	67.5%
Yellow Time (s)	3.0	4.0	4.0	3.0	4.0		3.0	4.0		3.0	4.0	4.0
All-Red Time (s)	2.0	2.0	2.0	2.0	2.0		2.0	2.0		2.0	2.0	2.0
Lost Time Adjust (s)	0.0	0.0	0.0	0.0	0.0		0.0	0.0		0.0	0.0	0.0
Total Lost Time (s)	5.0	6.0	6.0	5.0	6.0		5.0	6.0		5.0	6.0	6.0
Lead/Lag	Lead	Lag	Lag	Lead	Lag		Lead	Lag		Lead	Lag	Lag
Lead-Lag Optimize?	Yes	Yes	Yes	Yes	Yes		Yes	Yes		Yes	Yes	Yes
Recall Mode	None	None	None	None	None		None	C-Max		None	C-Max	C-Max
Act Effct Green (s)	23.6	16.6	16.6	12.6	6.6		80.3	75.2		83.5	75.2	75.2
Actuated g/C Ratio	0.20	0.14	0.14	0.10	0.06		0.67	0.63		0.70	0.63	0.63
v/c Ratio	0.59	0.25	0.18	0.18	0.56		0.19	0.75		0.47	0.44	0.24
Control Delay	47.6	51.1	1.2	42.4	35.2		6.1	18.4		20.9	12.1	1.6
Queue Delay	0.0	0.0	0.0	0.0	0.0		0.0	0.0		0.0	0.0	0.0
Total Delay	47.6	51.1	1.2	42.4	35.2		6.1	18.4		20.9	12.1	1.6
LOS	D	D	A	D	D		A	B		C	B	A
Approach Delay		41.4			36.4			18.0			11.0	
Approach LOS		D			D			B			B	
Queue Length 50th (ft)	96	46	0	18	24		9	469		17	191	0
Queue Length 95th (ft)	139	92	0	44	58		16	556		59	223	30
Internal Link Dist (ft)		695			413			423			624	
Turn Bay Length (ft)	285		285	195			175			455		
Base Capacity (vph)	473	257	320	158	257		491	3185		197	3186	1088
Starvation Cap Reductn	0	0	0	0	0		0	0		0	0	0
Spillback Cap Reductn	0	0	0	0	0		0	0		0	0	0
Storage Cap Reductn	0	0	0	0	0		0	0		0	0	0
Reduced v/c Ratio	0.59	0.25	0.18	0.18	0.54		0.19	0.75		0.42	0.44	0.24

Intersection Summary









Cycle Length: 120
 Actuated Cycle Length: 120
 Offset: 42 (35%), Referenced to phase 2:SBTL and 6:NBTL, Start of Green
 Natural Cycle: 70
 Control Type: Actuated-Coordinated

Timings
 1: Front Street & Founders Parkway (SH 86)

Total Traffic Volumes
 Year 2041 - AM Peak Hour

Maximum v/c Ratio: 0.75	
Intersection Signal Delay: 18.0	Intersection LOS: B
Intersection Capacity Utilization 76.3%	ICU Level of Service D
Analysis Period (min) 15	

Splits and Phases: 1: Front Street & Founders Parkway (SH 86)

 Ø1	 Ø2 (R)	 Ø3	 Ø4
10 s	81 s	10 s	19 s
 Ø5	 Ø6 (R)	 Ø7	 Ø8
14 s	77 s	16 s	13 s

Timings
2: Allen Way & Founders Parkway (SH 86)

Total Traffic Volumes
Year 2041 - AM Peak Hour

Lane Group	EBL	EBT	EBR	WBL	WBT	WBR	NBL	NBT	NBR	SBL	SBT	SBR
Lane Configurations												
Traffic Volume (vph)	373	1418	197	55	2287	195	140	29	269	95	25	442
Future Volume (vph)	373	1418	197	55	2287	195	140	29	269	95	25	442
Satd. Flow (prot)	3433	5085	1583	1770	5085	1583	3433	1611	0	3433	1863	2787
Flt Permitted	0.950			0.146			0.740			0.222		
Satd. Flow (perm)	3433	5085	1583	272	5085	1583	2674	1611	0	802	1863	2787
Satd. Flow (RTOR)			214			154		102				428
Lane Group Flow (vph)	405	1541	214	60	2486	212	152	324	0	103	27	480
Turn Type	Prot	NA	Perm	pm+pt	NA	Perm	pm+pt	NA		pm+pt	NA	Perm
Protected Phases	5	2		1	6		7	4		3	8	
Permitted Phases			2	6		6	4			8		8
Detector Phase	5	2	2	1	6	6	7	4		3	8	8
Switch Phase												
Minimum Initial (s)	5.0	20.0	20.0	5.0	20.0	20.0	5.0	5.0		5.0	5.0	5.0
Minimum Split (s)	10.0	26.0	26.0	10.0	26.0	26.0	10.0	11.0		11.0	11.0	11.0
Total Split (s)	20.0	76.0	76.0	10.0	66.0	66.0	10.0	23.0		11.0	24.0	24.0
Total Split (%)	16.7%	63.3%	63.3%	8.3%	55.0%	55.0%	8.3%	19.2%		9.2%	20.0%	20.0%
Yellow Time (s)	3.0	4.0	4.0	3.0	4.0	4.0	3.0	4.0		3.0	4.0	4.0
All-Red Time (s)	2.0	2.0	2.0	2.0	2.0	2.0	2.0	2.0		2.0	2.0	2.0
Lost Time Adjust (s)	0.0	0.0	0.0	0.0	0.0	0.0	0.0	0.0		0.0	0.0	0.0
Total Lost Time (s)	5.0	6.0	6.0	5.0	6.0	6.0	5.0	6.0		5.0	6.0	6.0
Lead/Lag	Lead	Lead	Lead	Lag	Lag	Lag	Lead	Lag		Lead	Lag	Lag
Lead-Lag Optimize?	Yes	Yes	Yes	Yes	Yes	Yes	Yes	Yes		Yes	Yes	Yes
Recall Mode	None	C-Min	C-Min	None	C-Min	C-Min	None	None		None	None	None
Act Effct Green (s)	15.0	58.2	58.2	61.0	60.0	60.0	23.0	17.0		25.0	18.0	18.0
Actuated g/C Ratio	0.12	0.48	0.48	0.51	0.50	0.50	0.19	0.14		0.21	0.15	0.15
v/c Ratio	0.94	0.62	0.24	0.16	0.98	0.24	0.28	1.03		0.35	0.10	0.61
Control Delay	85.1	21.3	1.7	22.2	43.0	5.8	38.3	93.2		40.6	47.8	14.2
Queue Delay	0.0	0.1	0.0	0.0	0.0	0.0	0.1	0.0		0.0	0.0	0.3
Total Delay	85.1	21.4	1.7	22.2	43.0	5.8	38.4	93.2		40.6	47.8	14.5
LOS	F	C	A	C	D	A	D	F		D	D	B
Approach Delay		31.4			39.7			75.7			20.4	
Approach LOS		C			D			E			C	
Queue Length 50th (ft)	158	300	0	23	668	23	48	~195		34	19	0
Queue Length 95th (ft)	#260	281	22	46	#809	64	77	#380		62	m50	97
Internal Link Dist (ft)		347			406			277			368	
Turn Bay Length (ft)	300			330			80			120		100
Base Capacity (vph)	429	3051	1035	373	2542	868	544	315		298	279	781
Starvation Cap Reductn	0	434	0	0	0	0	0	0		0	0	0
Spillback Cap Reductn	0	0	0	0	0	0	48	0		0	0	50
Storage Cap Reductn	0	0	0	0	0	0	0	0		0	0	0
Reduced v/c Ratio	0.94	0.59	0.21	0.16	0.98	0.24	0.31	1.03		0.35	0.10	0.66

Intersection Summary

Cycle Length: 120
 Actuated Cycle Length: 120
 Offset: 36 (30%), Referenced to phase 2:EBT and 6:WBTL, Start of Green
 Natural Cycle: 100
 Control Type: Actuated-Coordinated

Timings
 2: Allen Way & Founders Parkway (SH 86)

Total Traffic Volumes
 Year 2041 - AM Peak Hour

Maximum v/c Ratio: 1.03
 Intersection Signal Delay: 37.6 Intersection LOS: D
 Intersection Capacity Utilization 95.5% ICU Level of Service F
 Analysis Period (min) 15
 ~ Volume exceeds capacity, queue is theoretically infinite.
 Queue shown is maximum after two cycles.
 # 95th percentile volume exceeds capacity, queue may be longer.
 Queue shown is maximum after two cycles.
 m Volume for 95th percentile queue is metered by upstream signal.

Splits and Phases: 2: Allen Way & Founders Parkway (SH 86)













→ Ø2 (R)	↓	↙ Ø1	↘ Ø3	↑ Ø4
76 s		10 s	11 s	23 s
↖ Ø5	↗ Ø6 (R)	↙ Ø7	↓ Ø8	
20 s	66 s	10 s	24 s	

Timings

3: I-25 NB Off-Ramp/I-25 NB On-Ramp & Founders Parkway (SH 86)

Total Traffic Volumes

Year 2041 - AM Peak Hour

												
Lane Group	EBL	EBT	EBR	WBL	WBT	WBR	NBL	NBT	NBR	SBL	SBT	SBR
Lane Configurations		↑↑↑	↗		↑↑	↗	↘↘		↘↘			
Traffic Volume (vph)	0	1454	785	0	1111	1902	320	0	321	0	0	0
Future Volume (vph)	0	1454	785	0	1111	1902	320	0	321	0	0	0
Satd. Flow (prot)	0	4691	1362	0	3156	1441	3433	0	2787	0	0	0
Flt Permitted							0.950					
Satd. Flow (perm)	0	4691	1362	0	3156	1441	3433	0	2787	0	0	0
Satd. Flow (RTOR)		90	546		533	1033			119			
Lane Group Flow (vph)	0	1887	546	0	2242	1033	348	0	349	0	0	0
Turn Type		NA	Free		NA	Free	Prot		Prot			
Protected Phases		2			2		4		4			
Permitted Phases			Free			Free						
Detector Phase		2			2		4		4			
Switch Phase												
Minimum Initial (s)		20.0			20.0		5.0		5.0			
Minimum Split (s)		26.0			26.0		10.5		10.5			
Total Split (s)		97.0			97.0		23.0		23.0			
Total Split (%)		80.8%			80.8%		19.2%		19.2%			
Yellow Time (s)		4.0			4.0		3.5		3.5			
All-Red Time (s)		2.0			2.0		2.0		2.0			
Lost Time Adjust (s)		0.0			0.0		0.0		0.0			
Total Lost Time (s)		6.0			6.0		5.5		5.5			
Lead/Lag												
Lead-Lag Optimize?												
Recall Mode		C-Max			C-Max		None		None			
Act Effct Green (s)		92.4	120.0		92.4	120.0	16.1		16.1			
Actuated g/C Ratio		0.77	1.00		0.77	1.00	0.13		0.13			
v/c Ratio		0.52	0.40		0.88	0.72	0.75		0.73			
Control Delay		5.7	0.9		10.3	9.4	60.9		42.0			
Queue Delay		0.0	0.0		15.3	0.0	0.0		0.0			
Total Delay		5.7	0.9		25.6	9.4	60.9		42.0			
LOS		A	A		C	A	E		D			
Approach Delay		4.6			20.5			51.4				
Approach LOS		A			C			D				
Queue Length 50th (ft)		182	0		235	224	134		97			
Queue Length 95th (ft)		213	0		m206	m215	185		154			
Internal Link Dist (ft)		649			347			213			215	
Turn Bay Length (ft)			500						100			
Base Capacity (vph)		3631	1362		2551	1441	500		508			
Starvation Cap Reductn		0	0		358	0	0		0			
Spillback Cap Reductn		0	0		0	0	0		0			
Storage Cap Reductn		0	0		0	0	0		0			
Reduced v/c Ratio		0.52	0.40		1.02	0.72	0.70		0.69			
Intersection Summary												
Cycle Length: 120												
Actuated Cycle Length: 120												
Offset: 35 (29%), Referenced to phase 2:EBWB, Start of Green												
Natural Cycle: 70												
Control Type: Actuated-Coordinated												

Timings

3: I-25 NB Off-Ramp/I-25 NB On-Ramp & Founders Parkway (SH 86)

Total Traffic Volumes

Year 2041 - AM Peak Hour

Maximum v/c Ratio: 0.88

Intersection Signal Delay: 17.8

Intersection LOS: B

Intersection Capacity Utilization 68.5%

ICU Level of Service C

Analysis Period (min) 15























m Volume for 95th percentile queue is metered by upstream signal.

Splits and Phases: 3: I-25 NB Off-Ramp/I-25 NB On-Ramp & Founders Parkway (SH 86)

 Ø2 (R)	 Ø4
97 s	23 s

Timings
4: Allen Way & Allen Street

Total Traffic Volumes
Year 2041 - AM Peak Hour

												
Lane Group	EBL	EBT	EBR	WBL	WBT	WBR	NBL	NBT	NBR	SBL	SBT	SBR
Lane Configurations												
Traffic Volume (vph)	9	17	131	95	26	78	170	368	60	31	321	5
Future Volume (vph)	9	17	131	95	26	78	170	368	60	31	321	5
Satd. Flow (prot)	1770	1615	0	1770	1863	1583	1770	3539	1583	0	3518	0
Flt Permitted	0.463			0.656			0.522				0.902	
Satd. Flow (perm)	862	1615	0	1222	1863	1583	972	3539	1583	0	3186	0
Satd. Flow (RTOR)		142				218			218		3	
Lane Group Flow (vph)	10	160	0	103	28	85	185	400	65	0	388	0
Turn Type	pm+pt	NA		Perm	NA	Perm	Perm	NA	Perm	D.P+P	NA	
Protected Phases	3	8			4			6		5	2	
Permitted Phases	8			4		4	6		6	6		
Detector Phase	3	8		4	4	4	6	6	6	5	2	
Switch Phase												
Minimum Initial (s)	3.0	5.0		5.0	5.0	5.0	5.0	5.0	5.0	3.0	5.0	
Minimum Split (s)	8.0	10.0		10.0	10.0	10.0	10.0	10.0	10.0	8.0	10.0	
Total Split (s)	8.0	24.0		16.0	16.0	16.0	28.0	28.0	28.0	8.0	36.0	
Total Split (%)	13.3%	40.0%		26.7%	26.7%	26.7%	46.7%	46.7%	46.7%	13.3%	60.0%	
Yellow Time (s)	3.0	3.0		3.0	3.0	3.0	3.0	3.0	3.0	3.0	3.0	
All-Red Time (s)	2.0	2.0		2.0	2.0	2.0	2.0	2.0	2.0	2.0	2.0	
Lost Time Adjust (s)	0.0	0.0		0.0	0.0	0.0	0.0	0.0	0.0		0.0	
Total Lost Time (s)	5.0	5.0		5.0	5.0	5.0	5.0	5.0	5.0		5.0	
Lead/Lag	Lead			Lag	Lag	Lag	Lag	Lag	Lag	Lead		
Lead-Lag Optimize?	Yes			Yes	Yes	Yes	Yes	Yes	Yes	Yes		
Recall Mode	None	None		None	None	None	C-Min	C-Min	C-Min	None	C-Min	
Act Effct Green (s)	11.3	11.3		9.5	9.5	9.5	41.8	41.8	41.8		41.8	
Actuated g/C Ratio	0.19	0.19		0.16	0.16	0.16	0.70	0.70	0.70		0.70	
v/c Ratio	0.04	0.38		0.53	0.10	0.20	0.27	0.16	0.06		0.17	
Control Delay	16.7	7.5		33.1	21.2	1.0	4.8	2.3	0.1		5.3	
Queue Delay	0.0	0.0		0.0	0.0	0.0	0.0	0.0	0.0		0.0	
Total Delay	16.7	7.5		33.1	21.2	1.0	4.8	2.3	0.1		5.3	
LOS	B	A		C	C	A	A	A	A		A	
Approach Delay		8.0			19.0			2.8			5.3	
Approach LOS		A			B			A			A	
Queue Length 50th (ft)	3	6		34	9	0	23	18	0		22	
Queue Length 95th (ft)	11	38		75	27	0	m20	m21	m0		61	
Internal Link Dist (ft)		422			420			368			300	
Turn Bay Length (ft)	60			95		65	70		95			
Base Capacity (vph)	243	613		229	348	473	677	2465	1169		2232	
Starvation Cap Reductn	0	0		0	0	0	0	0	0		0	
Spillback Cap Reductn	0	0		0	0	0	0	0	0		0	
Storage Cap Reductn	0	0		0	0	0	0	0	0		0	
Reduced v/c Ratio	0.04	0.26		0.45	0.08	0.18	0.27	0.16	0.06		0.17	

Intersection Summary

Cycle Length: 60
 Actuated Cycle Length: 60
 Offset: 31 (52%), Referenced to phase 2:SBT and 6:NBSB, Start of Green
 Natural Cycle: 55
 Control Type: Actuated-Coordinated

Timings
 4: Allen Way & Allen Street

Total Traffic Volumes
 Year 2041 - AM Peak Hour

Maximum v/c Ratio: 0.53

Intersection Signal Delay: 6.5

Intersection LOS: A

Intersection Capacity Utilization 51.0%

ICU Level of Service A

Analysis Period (min) 15

m Volume for 95th percentile queue is metered by upstream signal.

Splits and Phases: 4: Allen Way & Allen Street

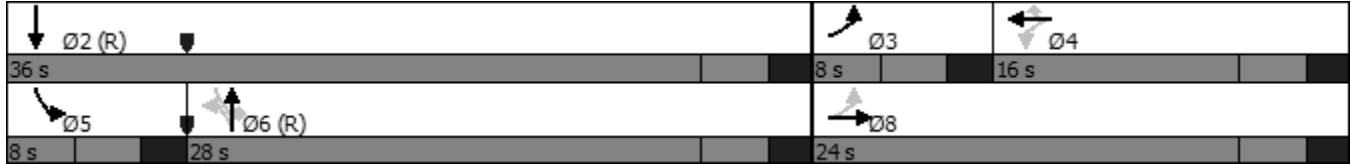

HCM 6th TWSC
5: Allen Street & Alexander Place

Total Traffic Volumes
Year 2041 - AM Peak Hour

Intersection												
Int Delay, s/veh	6											
Movement	EBL	EBT	EBR	WBL	WBT	WBR	NBL	NBT	NBR	SBL	SBT	SBR
Lane Configurations		↕↔		↕	↕		↕	↑	↗	↕	↕	
Traffic Vol, veh/h	39	4	26	51	4	130	33	103	65	52	47	21
Future Vol, veh/h	39	4	26	51	4	130	33	103	65	52	47	21
Conflicting Peds, #/hr	0	0	0	0	0	0	0	0	0	0	0	0
Sign Control	Stop	Stop	Stop	Stop	Stop	Stop	Free	Free	Free	Free	Free	Free
RT Channelized	-	-	None	-	-	None	-	-	None	-	-	None
Storage Length	-	-	-	60	-	-	75	-	75	80	-	-
Veh in Median Storage, #	-	0	-	-	0	-	-	0	-	-	0	-
Grade, %	-	0	-	-	0	-	-	0	-	-	0	-
Peak Hour Factor	92	92	92	92	92	92	92	92	92	92	92	92
Heavy Vehicles, %	2	2	2	2	2	2	2	2	2	2	2	2
Mvmt Flow	42	4	28	55	4	141	36	112	71	57	51	23

Major/Minor	Minor2		Minor1		Major1		Major2					
Conflicting Flow All	469	432	63	377	372	112	74	0	0	183	0	0
Stage 1	177	177	-	184	184	-	-	-	-	-	-	-
Stage 2	292	255	-	193	188	-	-	-	-	-	-	-
Critical Hdwy	7.12	6.52	6.22	7.12	6.52	6.22	4.12	-	-	4.12	-	-
Critical Hdwy Stg 1	6.12	5.52	-	6.12	5.52	-	-	-	-	-	-	-
Critical Hdwy Stg 2	6.12	5.52	-	6.12	5.52	-	-	-	-	-	-	-
Follow-up Hdwy	3.518	4.018	3.318	3.518	4.018	3.318	2.218	-	-	2.218	-	-
Pot Cap-1 Maneuver	505	516	1002	580	558	941	1526	-	-	1392	-	-
Stage 1	825	753	-	818	747	-	-	-	-	-	-	-
Stage 2	716	696	-	809	745	-	-	-	-	-	-	-
Platoon blocked, %								-	-	-	-	-
Mov Cap-1 Maneuver	406	483	1002	532	522	941	1526	-	-	1392	-	-
Mov Cap-2 Maneuver	406	483	-	532	522	-	-	-	-	-	-	-
Stage 1	805	722	-	798	729	-	-	-	-	-	-	-
Stage 2	591	679	-	749	714	-	-	-	-	-	-	-

Approach	EB	WB	NB	SB
HCM Control Delay, s	12.9	10.5	1.2	3.3
HCM LOS	B	B		

Minor Lane/Major Mvmt	NBL	NBT	NBR	EBLn1	WBLn1	WBLn2	SBL	SBT	SBR
Capacity (veh/h)	1526	-	-	530	532	919	1392	-	-
HCM Lane V/C Ratio	0.024	-	-	0.142	0.104	0.158	0.041	-	-
HCM Control Delay (s)	7.4	-	-	12.9	12.6	9.7	7.7	-	-
HCM Lane LOS	A	-	-	B	B	A	A	-	-
HCM 95th %tile Q(veh)	0.1	-	-	0.5	0.3	0.6	0.1	-	-

HCM 6th AWSC
6: Allen Street & Front Street

Total Traffic Volumes
Year 2041 - AM Peak Hour

Intersection	
Intersection Delay, s/veh	8.9
Intersection LOS	A

Movement	EBL	EBR	NBL	NBT	SBT	SBR
Lane Configurations	↙	↗	↙	↑	↑	↗
Traffic Vol, veh/h	89	57	78	133	93	70
Future Vol, veh/h	89	57	78	133	93	70
Peak Hour Factor	0.92	0.92	0.92	0.92	0.92	0.92
Heavy Vehicles, %	2	2	2	2	2	2
Mvmt Flow	97	62	85	145	101	76
Number of Lanes	1	1	1	1	1	1

Approach	EB	NB	SB
Opposing Approach		SB	NB
Opposing Lanes	0	2	2
Conflicting Approach Left	SB	EB	
Conflicting Lanes Left	2	2	0
Conflicting Approach Right	NB		EB
Conflicting Lanes Right	2	0	2
HCM Control Delay	9.2	9.2	8.3
HCM LOS	A	A	A

Lane	NBLn1	NBLn2	EBLn1	EBLn2	SBLn1	SBLn2
Vol Left, %	100%	0%	100%	0%	0%	0%
Vol Thru, %	0%	100%	0%	0%	100%	0%
Vol Right, %	0%	0%	0%	100%	0%	100%
Sign Control	Stop	Stop	Stop	Stop	Stop	Stop
Traffic Vol by Lane	78	133	89	57	93	70
LT Vol	78	0	89	0	0	0
Through Vol	0	133	0	0	93	0
RT Vol	0	0	0	57	0	70
Lane Flow Rate	85	145	97	62	101	76
Geometry Grp	7	7	7	7	7	7
Degree of Util (X)	0.133	0.206	0.161	0.083	0.146	0.095
Departure Headway (Hd)	5.637	5.134	6.006	4.8	5.203	4.498
Convergence, Y/N	Yes	Yes	Yes	Yes	Yes	Yes
Cap	636	698	597	744	688	794
Service Time	3.373	2.87	3.749	2.543	2.942	2.237
HCM Lane V/C Ratio	0.134	0.208	0.162	0.083	0.147	0.096
HCM Control Delay	9.2	9.2	9.9	8	8.8	7.7
HCM Lane LOS	A	A	A	A	A	A
HCM 95th-tile Q	0.5	0.8	0.6	0.3	0.5	0.3

HCM 6th TWSC
7: Private Access/Brewer Court & Alexander Place

Total Traffic Volumes
Year 2041 - AM Peak Hour

Intersection												
Int Delay, s/veh	5.4											
Movement	EBL	EBT	EBR	WBL	WBT	WBR	NBL	NBT	NBR	SBL	SBT	SBR
Lane Configurations	↕			↕			↕			↕		
Traffic Vol, veh/h	64	19	41	0	24	0	17	2	0	0	2	65
Future Vol, veh/h	64	19	41	0	24	0	17	2	0	0	2	65
Conflicting Peds, #/hr	0	0	0	0	0	0	0	0	0	0	0	0
Sign Control	Free	Free	Free	Free	Free	Free	Stop	Stop	Stop	Stop	Stop	Stop
RT Channelized	-	-	None	-	-	None	-	-	None	-	-	None
Storage Length	-	-	-	-	-	-	-	-	-	-	-	-
Veh in Median Storage, #	-	0	-	-	0	-	-	0	-	-	0	-
Grade, %	-	0	-	-	0	-	-	0	-	-	0	-
Peak Hour Factor	92	92	92	92	92	92	92	92	92	92	92	92
Heavy Vehicles, %	2	2	2	2	2	2	2	2	2	2	2	2
Mvmt Flow	70	21	45	0	26	0	18	2	0	0	2	71





























Major/Minor	Major1		Major2		Minor1		Minor2					
Conflicting Flow All	26	0	0	66	0	0	247	210	44	211	232	26
Stage 1	-	-	-	-	-	-	184	184	-	26	26	-
Stage 2	-	-	-	-	-	-	63	26	-	185	206	-
Critical Hdwy	4.12	-	-	4.12	-	-	7.12	6.52	6.22	7.12	6.52	6.22
Critical Hdwy Stg 1	-	-	-	-	-	-	6.12	5.52	-	6.12	5.52	-
Critical Hdwy Stg 2	-	-	-	-	-	-	6.12	5.52	-	6.12	5.52	-
Follow-up Hdwy	2.218	-	-	2.218	-	-	3.518	4.018	3.318	3.518	4.018	3.318
Pot Cap-1 Maneuver	1588	-	-	1536	-	-	707	687	1026	746	668	1050
Stage 1	-	-	-	-	-	-	818	747	-	992	874	-
Stage 2	-	-	-	-	-	-	948	874	-	817	731	-
Platoon blocked, %	-	-	-	-	-	-	-	-	-	-	-	-
Mov Cap-1 Maneuver	1588	-	-	1536	-	-	635	655	1026	718	637	1050
Mov Cap-2 Maneuver	-	-	-	-	-	-	635	655	-	718	637	-
Stage 1	-	-	-	-	-	-	780	713	-	946	874	-
Stage 2	-	-	-	-	-	-	882	874	-	777	697	-

Approach	EB	WB	NB	SB
HCM Control Delay, s	3.8	0	10.8	8.8
HCM LOS			B	A

Minor Lane/Major Mvmt	NBLn1	EBL	EBT	EBR	WBL	WBT	WBR	SBLn1
Capacity (veh/h)	637	1588	-	-	1536	-	-	1030
HCM Lane V/C Ratio	0.032	0.044	-	-	-	-	-	0.071
HCM Control Delay (s)	10.8	7.4	0	-	0	-	-	8.8
HCM Lane LOS	B	A	A	-	A	-	-	A
HCM 95th %tile Q(veh)	0.1	0.1	-	-	0	-	-	0.2

Timings
1: Front Street & Founders Parkway (SH 86)

Total Traffic Volumes
Year 2041 - PM Peak Hour

													
Lane Group	EBL	EBT	EBR	WBL	WBT	WBR	NBL	NBT	NBR	SBL	SBT	SBR	
Lane Configurations	 		 	 	 		 	  		 			
Traffic Volume (vph)	458	170	253	44	115	128	148	1980	20	235	2492	506	
Future Volume (vph)	458	170	253	44	115	128	148	1980	20	235	2492	506	
Satd. Flow (prot)	3433	1863	1583	1770	3260	0	3433	5075	0	1770	5085	1583	
Flt Permitted	0.280			0.641			0.068			0.063			
Satd. Flow (perm)	1012	1863	1583	1194	3260	0	246	5075	0	117	5085	1583	
Satd. Flow (RTOR)			164		139			2				431	
Lane Group Flow (vph)	498	185	275	48	264	0	161	2174	0	255	2709	550	
Turn Type	pm+pt	NA	Perm	pm+pt	NA		pm+pt	NA		pm+pt	NA	Perm	
Protected Phases	7	4		3	8		1	6		5	2		
Permitted Phases	4		4	8			6			2		2	
Detector Phase	7	4	4	3	8		1	6		5	2	2	
Switch Phase													
Minimum Initial (s)	3.0	5.0	5.0	3.0	5.0		3.0	20.0		3.0	20.0	20.0	
Minimum Split (s)	10.0	11.0	11.0	10.0	11.0		10.0	26.0		10.0	26.0	26.0	
Total Split (s)	20.0	25.0	25.0	10.0	15.0		10.0	64.0		21.0	75.0	75.0	
Total Split (%)	16.7%	20.8%	20.8%	8.3%	12.5%		8.3%	53.3%		17.5%	62.5%	62.5%	
Yellow Time (s)	3.0	4.0	4.0	3.0	4.0		3.0	4.0		3.0	4.0	4.0	
All-Red Time (s)	2.0	2.0	2.0	2.0	2.0		2.0	2.0		2.0	2.0	2.0	
Lost Time Adjust (s)	0.0	0.0	0.0	0.0	0.0		0.0	0.0		0.0	0.0	0.0	
Total Lost Time (s)	5.0	6.0	6.0	5.0	6.0		5.0	6.0		5.0	6.0	6.0	
Lead/Lag	Lead	Lag	Lag	Lead	Lag		Lead	Lag		Lead	Lag	Lag	
Lead-Lag Optimize?	Yes	Yes	Yes	Yes	Yes		Yes	Yes		Yes	Yes	Yes	
Recall Mode	None	None	None	None	None		None	C-Max		None	C-Max	C-Max	
Act Effct Green (s)	29.3	20.3	20.3	14.3	8.3		65.8	59.5		80.7	69.4	69.4	
Actuated g/C Ratio	0.24	0.17	0.17	0.12	0.07		0.55	0.50		0.67	0.58	0.58	
v/c Ratio	0.91	0.59	0.68	0.29	0.75		0.58	0.86		0.89	0.92	0.50	
Control Delay	62.3	55.3	28.7	40.8	39.2		22.8	31.6		62.1	29.5	4.7	
Queue Delay	0.0	0.0	0.0	0.0	0.0		0.0	0.0		0.0	0.0	0.0	
Total Delay	62.3	55.3	28.7	40.8	39.2		22.8	31.6		62.1	29.5	4.7	
LOS	E	E	C	D	D		C	C		E	C	A	
Approach Delay		51.3			39.5			31.0			28.0		
Approach LOS		D			D			C			C		
Queue Length 50th (ft)	175	135	80	29	50		20	541		142	664	40	
Queue Length 95th (ft)	#238	215	181	61	96		48	616		#288	749	109	
Internal Link Dist (ft)		695			413			423			624		
Turn Bay Length (ft)	285		285	195			175			455			
Base Capacity (vph)	549	316	404	166	373		277	2516		300	2939	1097	
Starvation Cap Reductn	0	0	0	0	0		0	0		0	0	0	
Spillback Cap Reductn	0	0	0	0	0		0	0		0	0	0	
Storage Cap Reductn	0	0	0	0	0		0	0		0	0	0	
Reduced v/c Ratio	0.91	0.59	0.68	0.29	0.71		0.58	0.86		0.85	0.92	0.50	

Intersection Summary

Cycle Length: 120
 Actuated Cycle Length: 120
 Offset: 112 (93%), Referenced to phase 2:SBTL and 6:NBTL, Start of Green
 Natural Cycle: 90
 Control Type: Actuated-Coordinated

Timings
 1: Front Street & Founders Parkway (SH 86)

Total Traffic Volumes
 Year 2041 - PM Peak Hour

Maximum v/c Ratio: 0.92

Intersection Signal Delay: 32.6

Intersection LOS: C

Intersection Capacity Utilization 91.1%









ICU Level of Service F

Analysis Period (min) 15

95th percentile volume exceeds capacity, queue may be longer.































Queue shown is maximum after two cycles.

Splits and Phases: 1: Front Street & Founders Parkway (SH 86)

 Ø1	 Ø2 (R)	 Ø3	 Ø4
10 s	75 s	10 s	25 s
 Ø5	 Ø6 (R)	 Ø7	 Ø8
21 s	64 s	20 s	15 s

Timings
2: Allen Way & Founders Parkway (SH 86)

Total Traffic Volumes
Year 2041 - PM Peak Hour

												
Lane Group	EBL	EBT	EBR	WBL	WBT	WBR	NBL	NBT	NBR	SBL	SBT	SBR
Lane Configurations	 	  	 	 	  	 	 	 				
Traffic Volume (vph)	555	3108	354	69	2314	185	232	41	51	98	89	618
Future Volume (vph)	555	3108	354	69	2314	185	232	41	51	98	89	618
Satd. Flow (prot)	3433	5085	1583	1770	5085	1583	3433	1708	0	3433	1863	2787
Flt Permitted	0.950			0.068			0.694			0.586		
Satd. Flow (perm)	3433	5085	1583	127	5085	1583	2508	1708	0	2118	1863	2787
Satd. Flow (RTOR)			293			149		40				497
Lane Group Flow (vph)	603	3378	385	75	2515	201	252	100	0	107	97	672
Turn Type	Prot	NA	Perm	pm+pt	NA	Perm	pm+pt	NA		pm+pt	NA	Perm
Protected Phases	5	2		1	6		7	4		3	8	
Permitted Phases			2	6		6	4			8		8
Detector Phase	5	2	2	1	6	6	7	4		3	8	8
Switch Phase												
Minimum Initial (s)	5.0	20.0	20.0	5.0	20.0	20.0	5.0	5.0		5.0	5.0	5.0
Minimum Split (s)	10.0	26.0	26.0	10.0	26.0	26.0	10.0	11.0		11.0	11.0	11.0
Total Split (s)	26.0	84.0	84.0	10.0	68.0	68.0	10.0	15.0		11.0	16.0	16.0
Total Split (%)	21.7%	70.0%	70.0%	8.3%	56.7%	56.7%	8.3%	12.5%		9.2%	13.3%	13.3%
Yellow Time (s)	3.0	4.0	4.0	3.0	4.0	4.0	3.0	4.0		3.0	4.0	4.0
All-Red Time (s)	2.0	2.0	2.0	2.0	2.0	2.0	2.0	2.0		2.0	2.0	2.0
Lost Time Adjust (s)	0.0	0.0	0.0	0.0	0.0	0.0	0.0	0.0		0.0	0.0	0.0
Total Lost Time (s)	5.0	6.0	6.0	5.0	6.0	6.0	5.0	6.0		5.0	6.0	6.0
Lead/Lag	Lead	Lead	Lead	Lag	Lag	Lag	Lead	Lag		Lead	Lag	Lag
Lead-Lag Optimize?	Yes	Yes	Yes	Yes	Yes	Yes	Yes	Yes		Yes	Yes	Yes
Recall Mode	None	C-Min	C-Min	None	C-Min	C-Min	None	None		None	None	None
Act Effct Green (s)	21.0	80.0	80.0	63.0	62.0	62.0	15.0	9.0		17.0	10.0	10.0
Actuated g/C Ratio	0.18	0.67	0.67	0.52	0.52	0.52	0.12	0.08		0.14	0.08	0.08
v/c Ratio	1.00	1.00	0.33	0.56	0.96	0.23	0.72	0.61		0.29	0.63	0.98
Control Delay	62.7	24.4	3.9	51.1	38.2	5.2	58.8	49.2		46.4	71.8	47.0
Queue Delay	0.0	39.5	0.8	0.0	3.4	0.0	0.0	0.0		0.0	0.0	2.0
Total Delay	62.7	63.9	4.7	51.1	41.5	5.2	58.8	49.2		46.4	71.8	49.0
LOS	E	E	A	D	D	A	E	D		D	E	D
Approach Delay		58.5			39.2			56.1			51.2	
Approach LOS		E			D			E			D	
Queue Length 50th (ft)	~251	~1012	49	28	658	19	90	45		38	74	92
Queue Length 95th (ft)	m218	m500	m33	#62	#769	59	#134	#112		m68	m#135	#251
Internal Link Dist (ft)		347			406			277			368	
Turn Bay Length (ft)	300			330			80			120		100
Base Capacity (vph)	600	3390	1153	135	2627	889	352	165		365	155	687
Starvation Cap Reductn	0	777	475	0	0	0	0	0		0	0	0
Spillback Cap Reductn	0	0	0	0	79	0	0	0		0	0	7
Storage Cap Reductn	0	0	0	0	0	0	0	0		0	0	0
Reduced v/c Ratio	1.00	1.29	0.57	0.56	0.99	0.23	0.72	0.61		0.29	0.63	0.99

Intersection Summary

Cycle Length: 120
 Actuated Cycle Length: 120
 Offset: 107 (89%), Referenced to phase 2:EBT and 6:WBTL, Start of Green
 Natural Cycle: 120
 Control Type: Actuated-Coordinated

Timings
 2: Allen Way & Founders Parkway (SH 86)

Total Traffic Volumes
 Year 2041 - PM Peak Hour

Maximum v/c Ratio: 1.00
 Intersection Signal Delay: 51.2 Intersection LOS: D
 Intersection Capacity Utilization 91.7% ICU Level of Service F
 Analysis Period (min) 15
 ~ Volume exceeds capacity, queue is theoretically infinite.
 Queue shown is maximum after two cycles.
 # 95th percentile volume exceeds capacity, queue may be longer.
 Queue shown is maximum after two cycles.
 m Volume for 95th percentile queue is metered by upstream signal.

Splits and Phases: 2: Allen Way & Founders Parkway (SH 86)













→ Ø2 (R)	↓	↙ Ø1	↘ Ø3	↑ Ø4
84 s		10 s	11 s	15 s
↖ Ø5	↗ Ø6 (R)	↙ Ø7	↓ Ø8	
26 s	68 s	10 s	16 s	

Timings

3: I-25 NB Off-Ramp/I-25 NB On-Ramp & Founders Parkway (SH 86)

Total Traffic Volumes

Year 2041 - PM Peak Hour

												
Lane Group	EBL	EBT	EBR	WBL	WBT	WBR	NBL	NBT	NBR	SBL	SBT	SBR
Lane Configurations		↑↑↑	↗		↑↑	↗	↘↘		↘↘			
Traffic Volume (vph)	0	3504	834	0	1753	1432	592	0	524	0	0	0
Future Volume (vph)	0	3504	834	0	1753	1432	592	0	524	0	0	0
Satd. Flow (prot)	0	4787	1362	0	3285	1441	3433	0	2787	0	0	0
Flt Permitted							0.950					
Satd. Flow (perm)	0	4787	1362	0	3285	1441	3433	0	2787	0	0	0
Satd. Flow (RTOR)		7	362		64	425			27			
Lane Group Flow (vph)	0	3900	816	0	2403	1059	643	0	570	0	0	0
Turn Type		NA	Free		NA	Free	Prot		Prot			
Protected Phases		2			2		4		4			
Permitted Phases			Free			Free						
Detector Phase		2			2		4		4			
Switch Phase												
Minimum Initial (s)		20.0			20.0		5.0		5.0			
Minimum Split (s)		26.0			26.0		10.5		10.5			
Total Split (s)		92.0			92.0		28.0		28.0			
Total Split (%)		76.7%			76.7%		23.3%		23.3%			
Yellow Time (s)		4.0			4.0		3.5		3.5			
All-Red Time (s)		2.0			2.0		2.0		2.0			
Lost Time Adjust (s)		0.0			0.0		0.0		0.0			
Total Lost Time (s)		6.0			6.0		5.5		5.5			
Lead/Lag												
Lead-Lag Optimize?												
Recall Mode		C-Max			C-Max		None		None			
Act Effct Green (s)		86.0	120.0		86.0	120.0	22.5		22.5			
Actuated g/C Ratio		0.72	1.00		0.72	1.00	0.19		0.19			
v/c Ratio		1.14	0.60		1.01	0.73	1.00		1.05			
Control Delay		84.9	2.0		24.8	7.5	84.4		96.7			
Queue Delay		0.1	0.0		34.1	0.0	0.0		34.9			
Total Delay		85.1	2.0		58.9	7.5	84.4		131.6			
LOS		F	A		E	A	F		F			
Approach Delay		70.7			43.2			106.6				
Approach LOS		E			D			F				
Queue Length 50th (ft)		~1368	0		~271	760	259		~262			
Queue Length 95th (ft)		#1443	0		m#1193	m823	#384		#390			
Internal Link Dist (ft)		649			347			213			215	
Turn Bay Length (ft)			500						100			
Base Capacity (vph)		3432	1362		2372	1441	643		544			
Starvation Cap Reductn		0	0		267	0	0		0			
Spillback Cap Reductn		253	0		0	0	0		390			
Storage Cap Reductn		0	0		0	0	0		0			
Reduced v/c Ratio		1.23	0.60		1.14	0.73	1.00		3.70			
Intersection Summary												
Cycle Length: 120												
Actuated Cycle Length: 120												
Offset: 106 (88%), Referenced to phase 2:EBWB, Start of Green												
Natural Cycle: 150												
Control Type: Actuated-Coordinated												

Timings

Total Traffic Volumes

3: I-25 NB Off-Ramp/I-25 NB On-Ramp & Founders Parkway (SH 86)

Year 2041 - PM Peak Hour

Maximum v/c Ratio: 1.14

Intersection Signal Delay: 65.2

Intersection LOS: E

Intersection Capacity Utilization 101.8%

ICU Level of Service G

Analysis Period (min) 15

~ Volume exceeds capacity, queue is theoretically infinite.

Queue shown is maximum after two cycles.

95th percentile volume exceeds capacity, queue may be longer.

Queue shown is maximum after two cycles.























m Volume for 95th percentile queue is metered by upstream signal.

Splits and Phases: 3: I-25 NB Off-Ramp/I-25 NB On-Ramp & Founders Parkway (SH 86)

 <p>Ø2 (R)</p> <p>92 s</p>	 <p>Ø4</p> <p>28 s</p>
---	---

Timings
4: Allen Way & Allen Street

Total Traffic Volumes
Year 2041 - PM Peak Hour

												
Lane Group	EBL	EBT	EBR	WBL	WBT	WBR	NBL	NBT	NBR	SBL	SBT	SBR
Lane Configurations												
Traffic Volume (vph)	2	88	125	233	35	65	214	463	135	26	507	14
Future Volume (vph)	2	88	125	233	35	65	214	463	135	26	507	14
Satd. Flow (prot)	1770	1699	0	1770	1863	1583	1770	3539	1583	0	3518	0
Flt Permitted	0.581			0.614			0.388				0.918	
Satd. Flow (perm)	1082	1699	0	1144	1863	1583	723	3539	1583	0	3236	0
Satd. Flow (RTOR)		131				218			218		6	
Lane Group Flow (vph)	2	232	0	253	38	71	233	503	147	0	594	0
Turn Type	pm+pt	NA		Perm	NA	Perm	Perm	NA	Perm	D.P+P	NA	
Protected Phases	3	8			4			6		5	2	
Permitted Phases	8			4		4	6		6	6		
Detector Phase	3	8		4	4	4	6	6	6	5	2	
Switch Phase												
Minimum Initial (s)	3.0	5.0		5.0	5.0	5.0	5.0	5.0	5.0	3.0	5.0	
Minimum Split (s)	8.0	10.0		10.0	10.0	10.0	10.0	10.0	10.0	8.0	10.0	
Total Split (s)	8.0	26.0		18.0	18.0	18.0	26.0	26.0	26.0	8.0	34.0	
Total Split (%)	13.3%	43.3%		30.0%	30.0%	30.0%	43.3%	43.3%	43.3%	13.3%	56.7%	
Yellow Time (s)	3.0	3.0		3.0	3.0	3.0	3.0	3.0	3.0	3.0	3.0	
All-Red Time (s)	2.0	2.0		2.0	2.0	2.0	2.0	2.0	2.0	2.0	2.0	
Lost Time Adjust (s)	0.0	0.0		0.0	0.0	0.0	0.0	0.0	0.0		0.0	
Total Lost Time (s)	5.0	5.0		5.0	5.0	5.0	5.0	5.0	5.0		5.0	
Lead/Lag	Lead			Lag	Lag	Lag	Lag	Lag	Lag	Lead		
Lead-Lag Optimize?	Yes			Yes	Yes	Yes	Yes	Yes	Yes	Yes		
Recall Mode	None	None		None	None	None	C-Min	C-Min	C-Min	None	C-Min	
Act Effct Green (s)	20.8	20.8		19.2	19.2	19.2	29.2	29.2	29.2		29.2	
Actuated g/C Ratio	0.35	0.35		0.32	0.32	0.32	0.49	0.49	0.49		0.49	
v/c Ratio	0.00	0.34		0.69	0.06	0.11	0.66	0.29	0.17		0.38	
Control Delay	13.0	8.3		33.8	16.2	0.3	24.1	6.1	0.6		10.5	
Queue Delay	0.0	0.0		0.0	0.0	0.0	0.0	0.0	0.0		0.0	
Total Delay	13.0	8.3		33.8	16.2	0.3	24.1	6.1	0.6		10.5	
LOS	B	A		C	B	A	C	A	A		B	
Approach Delay		8.3			25.4			9.9			10.5	
Approach LOS		A			C			A			B	
Queue Length 50th (ft)	1	25		74	9	0	68	35	1		65	
Queue Length 95th (ft)	4	68		#223	32	0	m95	m44	m0		98	
Internal Link Dist (ft)		422			420			368			300	
Turn Bay Length (ft)	60			95		65	70		95			
Base Capacity (vph)	420	680		365	595	653	352	1724	883		1581	
Starvation Cap Reductn	0	0		0	0	0	0	0	0		0	
Spillback Cap Reductn	0	0		0	0	0	0	0	0		0	
Storage Cap Reductn	0	0		0	0	0	0	0	0		0	
Reduced v/c Ratio	0.00	0.34		0.69	0.06	0.11	0.66	0.29	0.17		0.38	

Intersection Summary

Cycle Length: 60
 Actuated Cycle Length: 60
 Offset: 31 (52%), Referenced to phase 2:SBT and 6:NBSB, Start of Green
 Natural Cycle: 70
 Control Type: Actuated-Coordinated

Timings
 4: Allen Way & Allen Street

Total Traffic Volumes
 Year 2041 - PM Peak Hour

Maximum v/c Ratio: 0.69

Intersection Signal Delay: 12.6

Intersection LOS: B

Intersection Capacity Utilization 69.9%

ICU Level of Service C

Analysis Period (min) 15

95th percentile volume exceeds capacity, queue may be longer.

Queue shown is maximum after two cycles.

m Volume for 95th percentile queue is metered by upstream signal.

Splits and Phases: 4: Allen Way & Allen Street

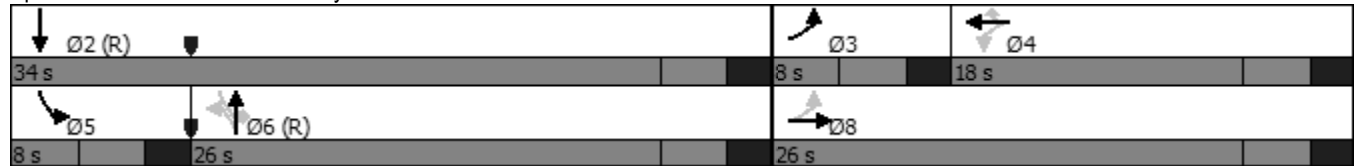

HCM 6th TWSC
5: Allen Street & Alexander Place

Total Traffic Volumes
Year 2041 - PM Peak Hour

Intersection												
Int Delay, s/veh	12.1											
Movement	EBL	EBT	EBR	WBL	WBT	WBR	NBL	NBT	NBR	SBL	SBT	SBR
Lane Configurations		↕		↕	↕		↕	↑	↕	↕	↕	
Traffic Vol, veh/h	84	18	75	136	11	101	82	151	147	80	145	24
Future Vol, veh/h	84	18	75	136	11	101	82	151	147	80	145	24
Conflicting Peds, #/hr	0	0	0	0	0	0	0	0	0	0	0	0
Sign Control	Stop	Stop	Stop	Stop	Stop	Stop	Free	Free	Free	Free	Free	Free
RT Channelized	-	-	None	-	-	None	-	-	None	-	-	None
Storage Length	-	-	-	60	-	-	75	-	75	80	-	-
Veh in Median Storage, #	-	0	-	-	0	-	-	0	-	-	0	-
Grade, %	-	0	-	-	0	-	-	0	-	-	0	-
Peak Hour Factor	92	92	92	92	92	92	92	92	92	92	92	92
Heavy Vehicles, %	2	2	2	2	2	2	2	2	2	2	2	2
Mvmt Flow	91	20	82	148	12	110	89	164	160	87	158	26

Major/Minor	Minor2		Minor1		Major1		Major2					
Conflicting Flow All	828	847	171	738	700	164	184	0	0	324	0	0
Stage 1	345	345	-	342	342	-	-	-	-	-	-	-
Stage 2	483	502	-	396	358	-	-	-	-	-	-	-
Critical Hdwy	7.12	6.52	6.22	7.12	6.52	6.22	4.12	-	-	4.12	-	-
Critical Hdwy Stg 1	6.12	5.52	-	6.12	5.52	-	-	-	-	-	-	-
Critical Hdwy Stg 2	6.12	5.52	-	6.12	5.52	-	-	-	-	-	-	-
Follow-up Hdwy	3.518	4.018	3.318	3.518	4.018	3.318	2.218	-	-	2.218	-	-
Pot Cap-1 Maneuver	290	299	873	334	363	881	1391	-	-	1236	-	-
Stage 1	671	636	-	673	638	-	-	-	-	-	-	-
Stage 2	565	542	-	629	628	-	-	-	-	-	-	-
Platoon blocked, %								-	-	-	-	-
Mov Cap-1 Maneuver	222	260	873	257	316	881	1391	-	-	1236	-	-
Mov Cap-2 Maneuver	222	260	-	257	316	-	-	-	-	-	-	-
Stage 1	628	591	-	630	597	-	-	-	-	-	-	-
Stage 2	454	507	-	513	584	-	-	-	-	-	-	-

Approach	EB		WB		NB		SB	
HCM Control Delay, s	29.8		24.8		1.7		2.6	
HCM LOS	D		C					

Minor Lane/Major Mvmt	NBL	NBT	NBR	EBLn1	WBLn1	WBLn2	SBL	SBT	SBR
Capacity (veh/h)	1391	-	-	332	257	749	1236	-	-
HCM Lane V/C Ratio	0.064	-	-	0.579	0.575	0.163	0.07	-	-
HCM Control Delay (s)	7.8	-	-	29.8	36.4	10.7	8.1	-	-
HCM Lane LOS	A	-	-	D	E	B	A	-	-
HCM 95th %tile Q(veh)	0.2	-	-	3.5	3.3	0.6	0.2	-	-

HCM 6th AWSC
6: Allen Street & Front Street

Total Traffic Volumes
Year 2041 - PM Peak Hour

Intersection	
Intersection Delay, s/veh	14.1
Intersection LOS	B

Movement	EBL	EBR	NBL	NBT	SBT	SBR
Lane Configurations	↙	↗	↙	↗	↗	↗
Traffic Vol, veh/h	249	185	115	222	219	167
Future Vol, veh/h	249	185	115	222	219	167
Peak Hour Factor	0.92	0.92	0.92	0.92	0.92	0.92
Heavy Vehicles, %	2	2	2	2	2	2
Mvmt Flow	271	201	125	241	238	182
Number of Lanes	1	1	1	1	1	1

Approach	EB	NB	SB
Opposing Approach		SB	NB
Opposing Lanes	0	2	2
Conflicting Approach Left	SB	EB	
Conflicting Lanes Left	2	2	0
Conflicting Approach Right	NB		EB
Conflicting Lanes Right	2	0	2
HCM Control Delay	15.3	13.9	13
HCM LOS	C	B	B

Lane	NBLn1	NBLn2	EBLn1	EBLn2	SBLn1	SBLn2
Vol Left, %	100%	0%	100%	0%	0%	0%
Vol Thru, %	0%	100%	0%	0%	100%	0%
Vol Right, %	0%	0%	0%	100%	0%	100%
Sign Control	Stop	Stop	Stop	Stop	Stop	Stop
Traffic Vol by Lane	115	222	249	185	219	167
LT Vol	115	0	249	0	0	0
Through Vol	0	222	0	0	219	0
RT Vol	0	0	0	185	0	167
Lane Flow Rate	125	241	271	201	238	182
Geometry Grp	7	7	7	7	7	7
Degree of Util (X)	0.248	0.445	0.538	0.332	0.437	0.297
Departure Headway (Hd)	7.147	6.636	7.161	5.945	6.604	5.89
Convergence, Y/N	Yes	Yes	Yes	Yes	Yes	Yes
Cap	501	541	503	603	543	608
Service Time	4.914	4.403	4.921	3.704	4.369	3.655
HCM Lane V/C Ratio	0.25	0.445	0.539	0.333	0.438	0.299
HCM Control Delay	12.3	14.7	18	11.7	14.4	11.2
HCM Lane LOS	B	B	C	B	B	B
HCM 95th-tile Q	1	2.3	3.1	1.4	2.2	1.2

HCM 6th TWSC
7: Private Access/Brewer Court & Alexander Place

Total Traffic Volumes
Year 2041 - PM Peak Hour

Intersection												
Int Delay, s/veh	8											
Movement	EBL	EBT	EBR	WBL	WBT	WBR	NBL	NBT	NBR	SBL	SBT	SBR
Lane Configurations	↕			↕			↕			↕		
Traffic Vol, veh/h	191	31	9	0	31	0	29	2	0	0	2	202
Future Vol, veh/h	191	31	9	0	31	0	29	2	0	0	2	202
Conflicting Peds, #/hr	0	0	0	0	0	0	0	0	0	0	0	0
Sign Control	Free	Free	Free	Free	Free	Free	Stop	Stop	Stop	Stop	Stop	Stop
RT Channelized	-	-	None	-	-	None	-	-	None	-	-	None
Storage Length	-	-	-	-	-	-	-	-	-	-	-	-
Veh in Median Storage, #	-	0	-	-	0	-	-	0	-	-	0	-
Grade, %	-	0	-	-	0	-	-	0	-	-	0	-
Peak Hour Factor	92	92	92	92	92	92	92	92	92	92	92	92
Heavy Vehicles, %	2	2	2	2	2	2	2	2	2	2	2	2
Mvmt Flow	208	34	10	0	34	0	32	2	0	0	2	220

Major/Minor	Major1		Major2		Minor1		Minor2					
Conflicting Flow All	34	0	0	44	0	0	600	489	39	490	494	34
Stage 1	-	-	-	-	-	-	455	455	-	34	34	-
Stage 2	-	-	-	-	-	-	145	34	-	456	460	-
Critical Hdwy	4.12	-	-	4.12	-	-	7.12	6.52	6.22	7.12	6.52	6.22
Critical Hdwy Stg 1	-	-	-	-	-	-	6.12	5.52	-	6.12	5.52	-
Critical Hdwy Stg 2	-	-	-	-	-	-	6.12	5.52	-	6.12	5.52	-
Follow-up Hdwy	2.218	-	-	2.218	-	-	3.518	4.018	3.318	3.518	4.018	3.318
Pot Cap-1 Maneuver	1578	-	-	1564	-	-	413	480	1033	489	476	1039
Stage 1	-	-	-	-	-	-	585	569	-	982	867	-
Stage 2	-	-	-	-	-	-	858	867	-	584	566	-
Platoon blocked, %	-	-	-	-	-	-	-	-	-	-	-	-
Mov Cap-1 Maneuver	1578	-	-	1564	-	-	291	415	1033	437	412	1039
Mov Cap-2 Maneuver	-	-	-	-	-	-	291	415	-	437	412	-
Stage 1	-	-	-	-	-	-	506	492	-	849	867	-
Stage 2	-	-	-	-	-	-	675	867	-	503	490	-

Approach	EB	WB	NB	SB
HCM Control Delay, s	6.3	0	18.7	9.5
HCM LOS			C	A

Minor Lane/Major Mvmt	NBLn1	EBL	EBT	EBR	WBL	WBT	WBR	SBLn1
Capacity (veh/h)	297	1578	-	-	1564	-	-	1024
HCM Lane V/C Ratio	0.113	0.132	-	-	-	-	-	0.217
HCM Control Delay (s)	18.7	7.6	0	-	0	-	-	9.5
HCM Lane LOS	C	A	A	-	A	-	-	A
HCM 95th %tile Q(veh)	0.4	0.5	-	-	0	-	-	0.8

Timings
1: Front Street & Founders Parkway (SH 86)

Total Traffic Volumes
Year 2041 - Saturday Peak Hour

Lane Group	SEL	SET	SER	NWL	NWT	NWR	NEL	NET	NER	SWL	SWT	SWR
Lane Configurations												
Traffic Volume (vph)	228	2026	562	162	2219	57	497	159	207	66	174	133
Future Volume (vph)	228	2026	562	162	2219	57	497	159	207	66	174	133
Satd. Flow (prot)	1770	5085	1583	3433	5065	0	3433	1863	1583	1770	3309	0
Flt Permitted	0.078			0.086			0.296			0.648		
Satd. Flow (perm)	145	5085	1583	311	5065	0	1070	1863	1583	1207	3309	0
Satd. Flow (RTOR)			420		5				172		110	
Lane Group Flow (vph)	248	2202	611	176	2474	0	540	173	225	72	334	0
Turn Type	pm+pt	NA	Perm	pm+pt	NA		pm+pt	NA	Perm	pm+pt	NA	
Protected Phases	5	2		1	6		7	4		3	8	
Permitted Phases	2		2	6			4		4	8		
Detector Phase	5	2	2	1	6		7	4	4	3	8	
Switch Phase												
Minimum Initial (s)	3.0	20.0	20.0	3.0	20.0		3.0	5.0	5.0	3.0	5.0	
Minimum Split (s)	10.0	26.0	26.0	10.0	26.0		10.0	11.0	11.0	10.0	11.0	
Total Split (s)	16.0	58.5	58.5	11.0	53.5		17.0	18.5	18.5	12.0	13.5	
Total Split (%)	16.0%	58.5%	58.5%	11.0%	53.5%		17.0%	18.5%	18.5%	12.0%	13.5%	
Yellow Time (s)	3.0	4.0	4.0	3.0	4.0		3.0	4.0	4.0	3.0	4.0	
All-Red Time (s)	2.0	2.0	2.0	2.0	2.0		2.0	2.0	2.0	2.0	2.0	
Lost Time Adjust (s)	0.0	0.0	0.0	0.0	0.0		0.0	0.0	0.0	0.0	0.0	
Total Lost Time (s)	5.0	6.0	6.0	5.0	6.0		5.0	6.0	6.0	5.0	6.0	
Lead/Lag	Lead	Lag	Lag	Lead	Lag		Lead	Lag	Lag	Lead	Lag	
Lead-Lag Optimize?	Yes	Yes	Yes	Yes	Yes		Yes	Yes	Yes	Yes	Yes	
Recall Mode	None	C-Max	C-Max	None	C-Max		None	None	None	None	None	
Act Effct Green (s)	64.5	52.5	52.5	54.5	47.5		25.5	14.9	14.9	15.2	7.5	
Actuated g/C Ratio	0.64	0.52	0.52	0.54	0.48		0.26	0.15	0.15	0.15	0.08	
v/c Ratio	0.91	0.83	0.59	0.49	1.03		0.97	0.62	0.59	0.33	0.96	
Control Delay	45.5	30.6	14.1	14.1	52.6		66.9	52.7	18.8	33.8	70.6	
Queue Delay	0.0	0.0	0.0	0.0	0.0		0.0	0.0	0.0	0.0	0.0	
Total Delay	45.5	30.6	14.1	14.1	52.6		66.9	52.7	18.8	33.8	70.6	
LOS	D	C	B	B	D		E	D	B	C	E	
Approach Delay		28.5			50.0			52.7			64.0	
Approach LOS		C			D			D			E	
Queue Length 50th (ft)	127	435	163	19	~620		157	108	31	36	75	
Queue Length 95th (ft)	m#163	m493	m222	35	#717		#233	#209	109	72	#166	
Internal Link Dist (ft)		1018			611			608			363	
Turn Bay Length (ft)	455			175			285		285	195		
Base Capacity (vph)	272	2669	1030	356	2408		556	277	382	226	349	
Starvation Cap Reductn	0	0	0	0	0		0	0	0	0	0	
Spillback Cap Reductn	0	0	0	0	0		0	0	0	0	0	
Storage Cap Reductn	0	0	0	0	0		0	0	0	0	0	
Reduced v/c Ratio	0.91	0.83	0.59	0.49	1.03		0.97	0.62	0.59	0.32	0.96	

Intersection Summary









Cycle Length: 100
 Actuated Cycle Length: 100
 Offset: 62 (62%), Referenced to phase 2:SETL and 6:NWTL, Start of Green
 Natural Cycle: 90
 Control Type: Actuated-Coordinated

Timings
 1: Front Street & Founders Parkway (SH 86)

Total Traffic Volumes
 Year 2041 - Saturday Peak Hour

































Maximum v/c Ratio: 1.03
 Intersection Signal Delay: 41.9 Intersection LOS: D
 Intersection Capacity Utilization 98.4% ICU Level of Service F
 Analysis Period (min) 15
 ~ Volume exceeds capacity, queue is theoretically infinite.
 Queue shown is maximum after two cycles.
 # 95th percentile volume exceeds capacity, queue may be longer.
 Queue shown is maximum after two cycles.
 m Volume for 95th percentile queue is metered by upstream signal.

Splits and Phases: 1: Front Street & Founders Parkway (SH 86)

 Ø1	 Ø2 (R)	 Ø3	 Ø4
11 s	58.5 s	12 s	18.5 s
 Ø5	 Ø6 (R)	 Ø7	 Ø8
16 s	53.5 s	17 s	13.5 s

Timings
2: Allen Way & Founders Parkway (SH 86)

Total Traffic Volumes
Year 2041 - Saturday Peak Hour

												
Lane Group	EBL	EBT	EBR	WBL	WBT	WBR	NBL	NBT	NBR	SBL	SBT	SBR
Lane Configurations	 	  			  		 			  		 
Traffic Volume (vph)	688	2491	323	64	2482	289	269	53	128	200	57	744
Future Volume (vph)	688	2491	323	64	2482	289	269	53	128	200	57	744
Satd. Flow (prot)	3433	5085	1583	1770	5085	1583	3433	1665	0	3433	1863	2787
Flt Permitted	0.950			0.091			0.717			0.571		
Satd. Flow (perm)	3433	5085	1583	170	5085	1583	2591	1665	0	2063	1863	2787
Satd. Flow (RTOR)			350			237		78				537
Lane Group Flow (vph)	748	2708	351	70	2698	314	292	197	0	217	62	809
Turn Type	Prot	NA	Perm	pm+pt	NA	Perm	pm+pt	NA		pm+pt	NA	Perm
Protected Phases	5	2		1	6		7	4		3	8	
Permitted Phases			2	6		6	4			8		8
Detector Phase	5	2	2	1	6	6	7	4		3	8	8
Switch Phase												
Minimum Initial (s)	5.0	20.0	20.0	5.0	20.0	20.0	5.0	5.0		5.0	5.0	5.0
Minimum Split (s)	10.0	26.0	26.0	10.0	26.0	26.0	10.0	11.0		11.0	11.0	11.0
Total Split (s)	23.0	66.0	66.0	10.0	53.0	53.0	11.0	12.0		12.0	13.0	13.0
Total Split (%)	23.0%	66.0%	66.0%	10.0%	53.0%	53.0%	11.0%	12.0%		12.0%	13.0%	13.0%
Yellow Time (s)	3.0	4.0	4.0	3.0	4.0	4.0	3.0	4.0		3.0	4.0	4.0
All-Red Time (s)	2.0	2.0	2.0	2.0	2.0	2.0	2.0	2.0		2.0	2.0	2.0
Lost Time Adjust (s)	0.0	0.0	0.0	0.0	0.0	0.0	0.0	0.0		0.0	0.0	0.0
Total Lost Time (s)	5.0	6.0	6.0	5.0	6.0	6.0	5.0	6.0		5.0	6.0	6.0
Lead/Lag	Lead	Lead	Lead	Lag	Lag	Lag	Lead	Lag		Lead	Lag	Lag
Lead-Lag Optimize?	Yes	Yes	Yes	Yes	Yes	Yes	Yes	Yes		Yes	Yes	Yes
Recall Mode	None	C-Min	C-Min	None	C-Min	C-Min	None	None		None	None	None
Act Effct Green (s)	18.0	62.0	62.0	48.0	47.0	47.0	13.0	6.0		15.0	7.0	7.0
Actuated g/C Ratio	0.18	0.62	0.62	0.48	0.47	0.47	0.13	0.06		0.15	0.07	0.07
v/c Ratio	1.21	0.86	0.32	0.43	1.13	0.36	0.75	1.14		0.54	0.48	1.17
Control Delay	138.7	13.4	1.3	20.0	78.5	2.0	51.1	138.1		40.7	57.4	105.1
Queue Delay	0.0	12.7	0.0	0.0	0.1	0.0	9.4	0.0		0.0	0.0	1.6
Total Delay	138.7	26.0	1.3	20.0	78.6	2.0	60.4	138.1		40.7	57.4	106.6
LOS	F	C	A	B	E	A	E	F		D	E	F
Approach Delay		45.9			69.5			91.7			90.7	
Approach LOS		D			E			F			F	
Queue Length 50th (ft)	~302	371	9	14	~734	25	85	~97		62	39	~154
Queue Length 95th (ft)	m#296	m360	m9	m14	m#717	m24	#137	#240		96	82	#288
Internal Link Dist (ft)		399			1018			243			294	
Turn Bay Length (ft)	300			330			90			120		100
Base Capacity (vph)	617	3153	1114	163	2389	869	387	173		405	130	694
Starvation Cap Reductn	0	486	0	0	0	0	0	0		0	0	0
Spillback Cap Reductn	0	0	0	0	78	0	68	0		0	0	138
Storage Cap Reductn	0	0	0	0	0	0	0	0		0	0	0
Reduced v/c Ratio	1.21	1.02	0.32	0.43	1.17	0.36	0.92	1.14		0.54	0.48	1.46

Intersection Summary

Cycle Length: 100

Actuated Cycle Length: 100

Offset: 0 (0%), Referenced to phase 2:EBT and 6:WBTL, Start of Green

Natural Cycle: 150

Control Type: Actuated-Coordinated

Timings
 2: Allen Way & Founders Parkway (SH 86)

Total Traffic Volumes
 Year 2041 - Saturday Peak Hour

Maximum v/c Ratio: 1.21
 Intersection Signal Delay: 62.9 Intersection LOS: E
 Intersection Capacity Utilization 102.3% ICU Level of Service G
 Analysis Period (min) 15
 ~ Volume exceeds capacity, queue is theoretically infinite.
 Queue shown is maximum after two cycles.
 # 95th percentile volume exceeds capacity, queue may be longer.
 Queue shown is maximum after two cycles.
 m Volume for 95th percentile queue is metered by upstream signal.

Splits and Phases: 2: Allen Way & Founders Parkway (SH 86)

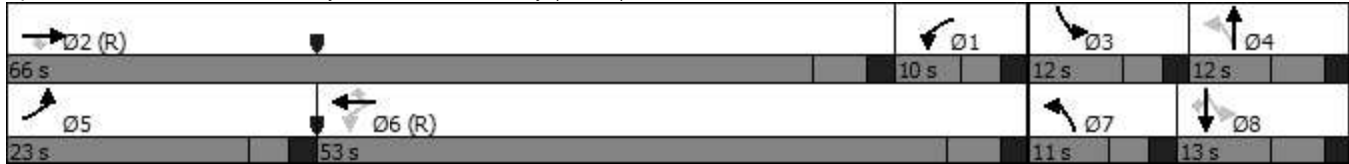

Timings

Total Traffic Volumes

3: I-25 NB Off-Ramp & Founders Parkway (SH 86) & I-25 NB On-Ramp Year 2041 - Saturday Peak Hour



Lane Group	EBL	EBT	EBR	WBL	WBT	WBR	NBL2	NBL	NBR	SEL	SER
Lane Configurations		↑↑↑	↗		↑↑	↗	↘↘		↘↘		
Traffic Volume (vph)	0	2936	738	0	1987	1518	760	0	570	0	0
Future Volume (vph)	0	2936	738	0	1987	1518	760	0	570	0	0
Satd. Flow (prot)	0	4787	1362	0	3295	1441	3433	0	2787	0	0
Flt Permitted							0.950				
Satd. Flow (perm)	0	4787	1362	0	3295	1441	3433	0	2787	0	0
Satd. Flow (RTOR)		8	459		58	474			33		
Lane Group Flow (vph)	0	3271	722	0	2655	1155	826	0	620	0	0
Turn Type		NA	Free		NA	Free	Prot		Prot		
Protected Phases		2			2		4		4		
Permitted Phases			Free			Free					
Detector Phase		2			2		4		4		
Switch Phase											
Minimum Initial (s)		20.0			20.0		5.0		5.0		
Minimum Split (s)		26.0			26.0		10.5		10.5		
Total Split (s)		74.0			74.0		26.0		26.0		
Total Split (%)		74.0%			74.0%		26.0%		26.0%		
Yellow Time (s)		4.0			4.0		3.5		3.5		
All-Red Time (s)		2.0			2.0		2.0		2.0		
Lost Time Adjust (s)		0.0			0.0		0.0		0.0		
Total Lost Time (s)		6.0			6.0		5.5		5.5		
Lead/Lag											
Lead-Lag Optimize?											
Recall Mode		C-Max			C-Max		None		None		
Act Effct Green (s)		68.0	100.0		68.0	100.0	20.5		20.5		
Actuated g/C Ratio		0.68	1.00		0.68	1.00	0.20		0.20		
v/c Ratio		1.00	0.53		1.18	0.80	1.17		1.04		
Control Delay		33.6	1.5		98.1	9.5	129.9		85.0		
Queue Delay		28.5	0.0		0.0	0.0	0.0		0.6		
Total Delay		62.1	1.5		98.1	9.5	129.9		85.6		
LOS		E	A		F	A	F		F		
Approach Delay		51.1			71.2			110.9			
Approach LOS		D			E			F			
Queue Length 50th (ft)		~733	0		~1091	297	~326		~233		
Queue Length 95th (ft)		#944	0		m#450	m114	#444		#356		
Internal Link Dist (ft)		429			399			361		299	
Turn Bay Length (ft)			500						100		
Base Capacity (vph)		3257	1362		2259	1441	703		597		
Starvation Cap Reductn		0	0		0	0	0		0		
Spillback Cap Reductn		228	0		0	0	0		1		
Storage Cap Reductn		0	0		0	0	0		0		
Reduced v/c Ratio		1.08	0.53		1.18	0.80	1.17		1.04		

Intersection Summary

Cycle Length: 100
Actuated Cycle Length: 100
Offset: 80 (80%), Referenced to phase 2:EBWB, Start of Green
Natural Cycle: 140
Control Type: Actuated-Coordinated

Timings

Total Traffic Volumes

3: I-25 NB Off-Ramp & Founders Parkway (SH 86) & I-25 NB On-Ramp Year 2041 - Saturday Peak Hour

Maximum v/c Ratio: 1.18

Intersection Signal Delay: 68.7

Intersection LOS: E

Intersection Capacity Utilization 101.1%

ICU Level of Service G

Analysis Period (min) 15

~ Volume exceeds capacity, queue is theoretically infinite.

Queue shown is maximum after two cycles.

95th percentile volume exceeds capacity, queue may be longer.

Queue shown is maximum after two cycles.























m Volume for 95th percentile queue is metered by upstream signal.

Splits and Phases: 3: I-25 NB Off-Ramp & Founders Parkway (SH 86) & I-25 NB On-Ramp

	
74 s	26 s

Timings
4: Allen Way & Allen Street

Total Traffic Volumes
Year 2041 - Saturday Peak Hour

												
Lane Group	EBL	EBT	EBR	WBL	WBT	WBR	NBL	NBT	NBR	SBL	SBT	SBR
Lane Configurations												
Traffic Volume (vph)	14	79	198	209	80	102	226	559	130	83	518	5
Future Volume (vph)	14	79	198	209	80	102	226	559	130	83	518	5
Satd. Flow (prot)	1770	1663	0	1770	1863	1583	1770	3539	1583	0	3511	0
Flt Permitted	0.551			0.577			0.353				0.791	
Satd. Flow (perm)	1026	1663	0	1075	1863	1583	658	3539	1583	0	2797	0
Satd. Flow (RTOR)		215				218			218		2	
Lane Group Flow (vph)	15	301	0	227	87	111	246	608	141	0	658	0
Turn Type	pm+pt	NA		Perm	NA	Perm	Perm	NA	Perm	D.P+P	NA	
Protected Phases	3	8			4			6		5	2	
Permitted Phases	8			4		4	6		6	6		
Detector Phase	3	8		4	4	4	6	6	6	5	2	
Switch Phase												
Minimum Initial (s)	3.0	5.0		5.0	5.0	5.0	5.0	5.0	5.0	3.0	5.0	
Minimum Split (s)	8.0	10.0		10.0	10.0	10.0	10.0	10.0	10.0	8.0	10.0	
Total Split (s)	8.0	25.0		17.0	17.0	17.0	27.0	27.0	27.0	8.0	35.0	
Total Split (%)	13.3%	41.7%		28.3%	28.3%	28.3%	45.0%	45.0%	45.0%	13.3%	58.3%	
Yellow Time (s)	3.0	3.0		3.0	3.0	3.0	3.0	3.0	3.0	3.0	3.0	
All-Red Time (s)	2.0	2.0		2.0	2.0	2.0	2.0	2.0	2.0	2.0	2.0	
Lost Time Adjust (s)	0.0	0.0		0.0	0.0	0.0	0.0	0.0	0.0		0.0	
Total Lost Time (s)	5.0	5.0		5.0	5.0	5.0	5.0	5.0	5.0		5.0	
Lead/Lag	Lead			Lag	Lag	Lag	Lag	Lag	Lag	Lead		
Lead-Lag Optimize?	Yes			Yes	Yes	Yes	Yes	Yes	Yes	Yes		
Recall Mode	None	None		None	None	None	C-Min	C-Min	C-Min	None	C-Min	
Act Effct Green (s)	20.1	20.1		18.5	18.5	18.5	29.9	29.9	29.9		29.9	
Actuated g/C Ratio	0.34	0.34		0.31	0.31	0.31	0.50	0.50	0.50		0.50	
v/c Ratio	0.04	0.43		0.69	0.15	0.17	0.75	0.34	0.16		0.47	
Control Delay	13.9	7.2		35.3	17.6	0.6	30.3	9.8	0.8		11.2	
Queue Delay	0.0	0.0		0.0	0.0	0.0	0.0	0.0	0.0		0.0	
Total Delay	13.9	7.2		35.3	17.6	0.6	30.3	9.8	0.8		11.2	
LOS	B	A		D	B	A	C	A	A		B	
Approach Delay		7.5			22.6			13.6			11.2	
Approach LOS		A			C			B			B	
Queue Length 50th (ft)	4	21		68	22	0	66	64	0		75	
Queue Length 95th (ft)	14	72		#210	60	1	#184	95	8		113	
Internal Link Dist (ft)		422			385			294			300	
Turn Bay Length (ft)	60			95		65	70		95			
Base Capacity (vph)	387	699		331	574	639	328	1763	898		1399	
Starvation Cap Reductn	0	0		0	0	0	0	0	0		0	
Spillback Cap Reductn	0	0		0	0	0	0	0	0		0	
Storage Cap Reductn	0	0		0	0	0	0	0	0		0	
Reduced v/c Ratio	0.04	0.43		0.69	0.15	0.17	0.75	0.34	0.16		0.47	

Intersection Summary

Cycle Length: 60
 Actuated Cycle Length: 60
 Offset: 31 (52%), Referenced to phase 2:SBT and 6:NBSB, Start of Green
 Natural Cycle: 75
 Control Type: Actuated-Coordinated

Timings
 4: Allen Way & Allen Street

Total Traffic Volumes
 Year 2041 - Saturday Peak Hour

Maximum v/c Ratio: 0.75

Intersection Signal Delay: 13.7

Intersection LOS: B

Intersection Capacity Utilization 76.9%

ICU Level of Service D

Analysis Period (min) 15

95th percentile volume exceeds capacity, queue may be longer.

Queue shown is maximum after two cycles.

Splits and Phases: 4: Allen Way & Allen Street

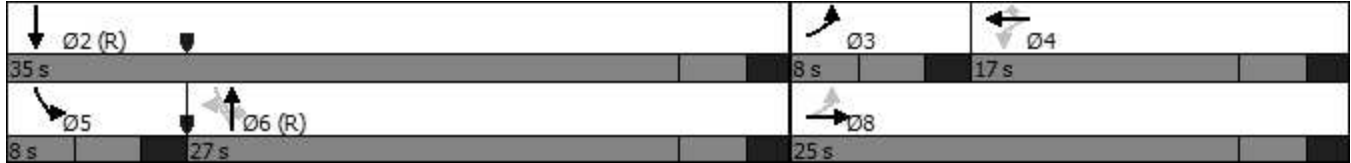

HCM 6th TWSC
5: Allen Street & Alexander Place

Total Traffic Volumes
Year 2041 - Saturday Peak Hour

Intersection												
Int Delay, s/veh	24.6											
Movement	SEL	SET	SER	NWL	NWT	NWR	NEL	NET	NER	SWL	SWT	SWR
Lane Configurations	↙	↘		↙	↑	↗		↔		↙	↘	
Traffic Vol, veh/h	83	192	38	82	194	161	110	6	70	197	10	78
Future Vol, veh/h	83	192	38	82	194	161	110	6	70	197	10	78
Conflicting Peds, #/hr	0	0	0	0	0	0	0	0	0	0	0	0
Sign Control	Free	Free	Free	Free	Free	Free	Stop	Stop	Stop	Stop	Stop	Stop
RT Channelized	-	-	None	-	-	None	-	-	None	-	-	None
Storage Length	80	-	-	75	-	75	-	-	-	60	-	-
Veh in Median Storage, #	-	0	-	-	0	-	-	0	-	-	0	-
Grade, %	-	0	-	-	0	-	-	0	-	-	0	-
Peak Hour Factor	92	92	92	92	92	92	92	92	92	92	92	92
Heavy Vehicles, %	2	2	2	2	2	2	2	2	2	2	2	2
Mvmt Flow	90	209	41	89	211	175	120	7	76	214	11	85

Major/Minor	Major1			Major2			Minor1			Minor2		
Conflicting Flow All	386	0	0	250	0	0	935	974	230	840	819	211
Stage 1	-	-	-	-	-	-	410	410	-	389	389	-
Stage 2	-	-	-	-	-	-	525	564	-	451	430	-
Critical Hdwy	4.12	-	-	4.12	-	-	7.12	6.52	6.22	7.12	6.52	6.22
Critical Hdwy Stg 1	-	-	-	-	-	-	6.12	5.52	-	6.12	5.52	-
Critical Hdwy Stg 2	-	-	-	-	-	-	6.12	5.52	-	6.12	5.52	-
Follow-up Hdwy	2.218	-	-	2.218	-	-	3.518	4.018	3.318	3.518	4.018	3.318
Pot Cap-1 Maneuver	1172	-	-	1316	-	-	246	252	809	285	310	829
Stage 1	-	-	-	-	-	-	619	595	-	635	608	-
Stage 2	-	-	-	-	-	-	536	508	-	588	583	-
Platoon blocked, %	-	-	-	-	-	-	-	-	-	-	-	-
Mov Cap-1 Maneuver	1172	-	-	1316	-	-	191	217	809	225	267	829
Mov Cap-2 Maneuver	-	-	-	-	-	-	191	217	-	225	267	-
Stage 1	-	-	-	-	-	-	571	549	-	586	567	-
Stage 2	-	-	-	-	-	-	440	473	-	486	538	-

Approach	SE			NW			NE			SW		
HCM Control Delay, s	2.2			1.5			49.5			68.2		
HCM LOS							E			F		

Minor Lane/Major Mvmt	NELn1	NWL	NWT	NWR	SEL	SET	SERSWLn1	SWLn2
Capacity (veh/h)	270	1316	-	-	1172	-	-	225 669
HCM Lane V/C Ratio	0.749	0.068	-	-	0.077	-	-	0.952 0.143
HCM Control Delay (s)	49.5	7.9	-	-	8.3	-	-	93.6 11.3
HCM Lane LOS	E	A	-	-	A	-	-	F B
HCM 95th %tile Q(veh)	5.4	0.2	-	-	0.2	-	-	8.3 0.5

HCM 6th AWSC
6: Front Street & Allen Street

Total Traffic Volumes
Year 2041 - Saturday Peak Hour

Intersection	
Intersection Delay, s/veh	17.3
Intersection LOS	C

Movement	SET	SER	NWL	NWT	NEL	NER
Lane Configurations	↑	↗	↖	↑	↘	↗
Traffic Vol, veh/h	244	262	118	257	295	142
Future Vol, veh/h	244	262	118	257	295	142
Peak Hour Factor	0.92	0.92	0.92	0.92	0.92	0.92
Heavy Vehicles, %	2	2	2	2	2	2
Mvmt Flow	265	285	128	279	321	154
Number of Lanes	1	1	1	1	1	1

Approach	SE	NW	NE
Opposing Approach	NW	SE	
Opposing Lanes	2	2	0
Conflicting Approach Left		NE	SE
Conflicting Lanes Left	0	2	2
Conflicting Approach Right	NE		NW
Conflicting Lanes Right	2	0	2
HCM Control Delay	15.5	16.3	20.3
HCM LOS	C	C	C

Lane	NELn1	NELn2	NWLn1	NWLn2	SELn1	SELn2
Vol Left, %	100%	0%	100%	0%	0%	0%
Vol Thru, %	0%	0%	0%	100%	100%	0%
Vol Right, %	0%	100%	0%	0%	0%	100%
Sign Control	Stop	Stop	Stop	Stop	Stop	Stop
Traffic Vol by Lane	295	142	118	257	244	262
LT Vol	295	0	118	0	0	0
Through Vol	0	0	0	257	244	0
RT Vol	0	142	0	0	0	262
Lane Flow Rate	321	154	128	279	265	285
Geometry Grp	7	7	7	7	7	7
Degree of Util (X)	0.672	0.271	0.267	0.542	0.504	0.485
Departure Headway (Hd)	7.548	6.327	7.495	6.983	6.845	6.129
Convergence, Y/N	Yes	Yes	Yes	Yes	Yes	Yes
Cap	478	565	476	514	522	584
Service Time	5.327	4.106	5.29	4.778	4.635	3.918
HCM Lane V/C Ratio	0.672	0.273	0.269	0.543	0.508	0.488
HCM Control Delay	24.6	11.5	13	17.8	16.5	14.6
HCM Lane LOS	C	B	B	C	C	B
HCM 95th-tile Q	4.9	1.1	1.1	3.2	2.8	2.6

HCM 6th TWSC
7: Private Access/Brewer Court & Alexander Place

Total Traffic Volumes
Year 2041 - Saturday Peak Hour

Intersection												
Int Delay, s/veh	7.7											
Movement	EBL	EBT	EBR	WBL	WBT	WBR	NBL	NBT	NBR	SBL	SBT	SBR
Lane Configurations	↕			↕			↕			↕		
Traffic Vol, veh/h	230	28	5	0	45	0	3	0	0	0	0	258
Future Vol, veh/h	230	28	5	0	45	0	3	0	0	0	0	258
Conflicting Peds, #/hr	0	0	0	0	0	0	0	0	0	0	0	0
Sign Control	Free	Free	Free	Free	Free	Free	Stop	Stop	Stop	Stop	Stop	Stop
RT Channelized	-	-	None	-	-	None	-	-	None	-	-	None
Storage Length	-	-	-	-	-	-	-	-	-	-	-	-
Veh in Median Storage, #	-	0	-	-	0	-	-	0	-	-	0	-
Grade, %	-	0	-	-	0	-	-	0	-	-	0	-
Peak Hour Factor	92	92	92	92	92	92	92	92	92	92	92	92
Heavy Vehicles, %	2	2	2	2	2	2	2	2	2	2	2	2
Mvmt Flow	250	30	5	0	49	0	3	0	0	0	0	280

Major/Minor	Major1			Major2			Minor1			Minor2		
Conflicting Flow All	49	0	0	35	0	0	722	582	33	582	584	49
Stage 1	-	-	-	-	-	-	533	533	-	49	49	-
Stage 2	-	-	-	-	-	-	189	49	-	533	535	-
Critical Hdwy	4.12	-	-	4.12	-	-	7.12	6.52	6.22	7.12	6.52	6.22
Critical Hdwy Stg 1	-	-	-	-	-	-	6.12	5.52	-	6.12	5.52	-
Critical Hdwy Stg 2	-	-	-	-	-	-	6.12	5.52	-	6.12	5.52	-
Follow-up Hdwy	2.218	-	-	2.218	-	-	3.518	4.018	3.318	3.518	4.018	3.318
Pot Cap-1 Maneuver	1558	-	-	1576	-	-	342	425	1041	424	423	1020
Stage 1	-	-	-	-	-	-	531	525	-	964	854	-
Stage 2	-	-	-	-	-	-	813	854	-	531	524	-
Platoon blocked, %	-	-	-	-	-	-	-	-	-	-	-	-
Mov Cap-1 Maneuver	1558	-	-	1576	-	-	217	355	1041	371	354	1020
Mov Cap-2 Maneuver	-	-	-	-	-	-	217	355	-	371	354	-
Stage 1	-	-	-	-	-	-	444	439	-	806	854	-
Stage 2	-	-	-	-	-	-	589	854	-	444	438	-

Approach	EB			WB			NB			SB		
HCM Control Delay, s	6.8			0			21.8			9.9		
HCM LOS							C			A		

Minor Lane/Major Mvmt	NBLn1	EBL	EBT	EBR	WBL	WBT	WBR	SBLn1
Capacity (veh/h)	217	1558	-	-	1576	-	-	1020
HCM Lane V/C Ratio	0.015	0.16	-	-	-	-	-	0.275
HCM Control Delay (s)	21.8	7.8	0	-	0	-	-	9.9
HCM Lane LOS	C	A	A	-	A	-	-	A
HCM 95th %tile Q(veh)	0	0.6	-	-	0	-	-	1.1

APPENDIX D

Capacity Worksheets – E Allen Street & Alexander Place

HCM 6th AWSC
5: Allen Street & Alexander Place

Total Traffic Volumes
Year 2041 - AM Peak Hour

Intersection	
Intersection Delay, s/veh	9.3
Intersection LOS	A

Movement	EBL	EBT	EBR	WBL	WBT	WBR	NBL	NBT	NBR	SBL	SBT	SBR
Lane Configurations		↕		↙	↘		↙	↕	↘	↙	↘	
Traffic Vol, veh/h	39	4	26	51	4	130	33	103	65	52	47	21
Future Vol, veh/h	39	4	26	51	4	130	33	103	65	52	47	21
Peak Hour Factor	0.92	0.92	0.92	0.92	0.92	0.92	0.92	0.92	0.92	0.92	0.92	0.92
Heavy Vehicles, %	2	2	2	2	2	2	2	2	2	2	2	2
Mvmt Flow	42	4	28	55	4	141	36	112	71	57	51	23
Number of Lanes	0	1	0	1	1	0	1	1	1	1	1	0

Approach	EB	WB	NB	SB
Opposing Approach	WB	EB	SB	NB
Opposing Lanes	2	1	2	3
Conflicting Approach Left	SB	NB	EB	WB
Conflicting Lanes Left	2	3	1	2
Conflicting Approach Right	NB	SB	WB	EB
Conflicting Lanes Right	3	2	2	1
HCM Control Delay	9.6	9.3	9.2	9.4
HCM LOS	A	A	A	A

Lane	NBLn1	NBLn2	NBLn3	EBLn1	WBLn1	WBLn2	SBLn1	SBLn2
Vol Left, %	100%	0%	0%	57%	100%	0%	100%	0%
Vol Thru, %	0%	100%	0%	6%	0%	3%	0%	69%
Vol Right, %	0%	0%	100%	38%	0%	97%	0%	31%
Sign Control	Stop	Stop	Stop	Stop	Stop	Stop	Stop	Stop
Traffic Vol by Lane	33	103	65	69	51	134	52	68
LT Vol	33	0	0	39	51	0	52	0
Through Vol	0	103	0	4	0	4	0	47
RT Vol	0	0	65	26	0	130	0	21
Lane Flow Rate	36	112	71	75	55	146	57	74
Geometry Grp	8	8	8	8	8	8	8	8
Degree of Util (X)	0.062	0.178	0.097	0.126	0.097	0.202	0.1	0.117
Departure Headway (Hd)	6.233	5.729	5.027	6.044	6.28	5.103	6.399	5.675
Convergence, Y/N	Yes	Yes	Yes	Yes	Yes	Yes	Yes	Yes
Cap	578	629	717	595	573	708	562	634
Service Time	3.937	3.433	2.727	3.762	3.987	2.803	4.113	3.389
HCM Lane V/C Ratio	0.062	0.178	0.099	0.126	0.096	0.206	0.101	0.117
HCM Control Delay	9.3	9.7	8.3	9.6	9.7	9.1	9.8	9.1
HCM Lane LOS	A	A	A	A	A	A	A	A
HCM 95th-tile Q	0.2	0.6	0.3	0.4	0.3	0.8	0.3	0.4

HCM 6th Roundabout
5: Allen Street & Alexander Place

Total Traffic Volumes
Year 2041 - AM Peak Hour

Intersection				
Intersection Delay, s/veh	4.4			
Intersection LOS	A			
Approach	EB	WB	NB	SB
Entry Lanes	1	1	1	1
Conflicting Circle Lanes	1	1	1	1
Adj Approach Flow, veh/h	74	200	219	131
Demand Flow Rate, veh/h	76	204	223	133
Vehicles Circulating, veh/h	166	194	105	97
Vehicles Exiting, veh/h	64	134	137	301
Ped Vol Crossing Leg, #/h	0	0	0	0
Ped Cap Adj	1.000	1.000	1.000	1.000
Approach Delay, s/veh	3.7	4.9	4.5	3.8
Approach LOS	A	A	A	A
Lane	Left	Left	Left	Left
Designated Moves	LTR	LTR	LTR	LTR
Assumed Moves	LTR	LTR	LTR	LTR
RT Channelized				
Lane Util	1.000	1.000	1.000	1.000
Follow-Up Headway, s	2.609	2.609	2.609	2.609
Critical Headway, s	4.976	4.976	4.976	4.976
Entry Flow, veh/h	76	204	223	133
Cap Entry Lane, veh/h	1165	1132	1240	1250
Entry HV Adj Factor	0.973	0.980	0.981	0.985
Flow Entry, veh/h	74	200	219	131
Cap Entry, veh/h	1133	1110	1216	1231
V/C Ratio	0.065	0.180	0.180	0.106
Control Delay, s/veh	3.7	4.9	4.5	3.8
LOS	A	A	A	A
95th %tile Queue, veh	0	1	1	0

HCM 6th AWSC
5: Allen Street & Alexander Place

Total Traffic Volumes
Year 2041 - PM Peak Hour

Intersection	
Intersection Delay, s/veh	13.7
Intersection LOS	B

Movement	EBL	EBT	EBR	WBL	WBT	WBR	NBL	NBT	NBR	SBL	SBT	SBR
Lane Configurations		↕		↙	↘		↙	↕	↘	↙	↘	
Traffic Vol, veh/h	84	18	75	136	11	101	82	151	147	80	145	24
Future Vol, veh/h	84	18	75	136	11	101	82	151	147	80	145	24
Peak Hour Factor	0.92	0.92	0.92	0.92	0.92	0.92	0.92	0.92	0.92	0.92	0.92	0.92
Heavy Vehicles, %	2	2	2	2	2	2	2	2	2	2	2	2
Mvmt Flow	91	20	82	148	12	110	89	164	160	87	158	26
Number of Lanes	0	1	0	1	1	0	1	1	1	1	1	0

Approach	EB	WB	NB	SB
Opposing Approach	WB	EB	SB	NB
Opposing Lanes	2	1	2	3
Conflicting Approach Left	SB	NB	EB	WB
Conflicting Lanes Left	2	3	1	2
Conflicting Approach Right	NB	SB	WB	EB
Conflicting Lanes Right	3	2	2	1
HCM Control Delay	15.7	13.4	12.7	14.1
HCM LOS	C	B	B	B

Lane	NBLn1	NBLn2	NBLn3	EBLn1	WBLn1	WBLn2	SBLn1	SBLn2
Vol Left, %	100%	0%	0%	47%	100%	0%	100%	0%
Vol Thru, %	0%	100%	0%	10%	0%	10%	0%	86%
Vol Right, %	0%	0%	100%	42%	0%	90%	0%	14%
Sign Control	Stop	Stop	Stop	Stop	Stop	Stop	Stop	Stop
Traffic Vol by Lane	82	151	147	177	136	112	80	169
LT Vol	82	0	0	84	136	0	80	0
Through Vol	0	151	0	18	0	11	0	145
RT Vol	0	0	147	75	0	101	0	24
Lane Flow Rate	89	164	160	192	148	122	87	184
Geometry Grp	8	8	8	8	8	8	8	8
Degree of Util (X)	0.192	0.331	0.29	0.41	0.331	0.234	0.195	0.38
Departure Headway (Hd)	7.762	7.251	6.536	7.673	8.067	6.916	8.065	7.449
Convergence, Y/N	Yes	Yes	Yes	Yes	Yes	Yes	Yes	Yes
Cap	462	496	550	469	445	519	444	483
Service Time	5.515	5.003	4.287	5.431	5.824	4.672	5.821	5.205
HCM Lane V/C Ratio	0.193	0.331	0.291	0.409	0.333	0.235	0.196	0.381
HCM Control Delay	12.4	13.6	12	15.7	14.8	11.8	12.8	14.7
HCM Lane LOS	B	B	B	C	B	B	B	B
HCM 95th-tile Q	0.7	1.4	1.2	2	1.4	0.9	0.7	1.8

HCM 6th Roundabout
5: Allen Street & Alexander Place

Total Traffic Volumes
Year 2041 - PM Peak Hour

Intersection				
Intersection Delay, s/veh	6.6			
Intersection LOS	A			
Approach	EB	WB	NB	SB
Entry Lanes	1	1	1	1
Conflicting Circle Lanes	1	1	1	1
Adj Approach Flow, veh/h	193	270	413	271
Demand Flow Rate, veh/h	197	275	421	277
Vehicles Circulating, veh/h	401	351	202	254
Vehicles Exiting, veh/h	130	272	396	372
Ped Vol Crossing Leg, #/h	0	0	0	0
Ped Cap Adj	1.000	1.000	1.000	1.000
Approach Delay, s/veh	6.2	6.7	7.1	6.0
Approach LOS	A	A	A	A
Lane	Left	Left	Left	Left
Designated Moves	LTR	LTR	LTR	LTR
Assumed Moves	LTR	LTR	LTR	LTR
RT Channelized				
Lane Util	1.000	1.000	1.000	1.000
Follow-Up Headway, s	2.609	2.609	2.609	2.609
Critical Headway, s	4.976	4.976	4.976	4.976
Entry Flow, veh/h	197	275	421	277
Cap Entry Lane, veh/h	917	965	1123	1065
Entry HV Adj Factor	0.978	0.981	0.980	0.978
Flow Entry, veh/h	193	270	413	271
Cap Entry, veh/h	896	946	1101	1041
V/C Ratio	0.215	0.285	0.375	0.260
Control Delay, s/veh	6.2	6.7	7.1	6.0
LOS	A	A	A	A
95th %tile Queue, veh	1	1	2	1

HCM 6th AWSC
5: Allen Street & Alexander Place

Total Traffic Volumes
Year 2041 - Saturday Peak Hour

Intersection	
Intersection Delay, s/veh	18
Intersection LOS	C

Movement	EBL	EBT	EBR	WBL	WBT	WBR	NBL	NBT	NBR	SBL	SBT	SBR
Lane Configurations		↔		↵	↶		↵	↑	↶	↵	↶	
Traffic Vol, veh/h	110	6	70	197	10	78	82	194	161	83	192	38
Future Vol, veh/h	110	6	70	197	10	78	82	194	161	83	192	38
Peak Hour Factor	0.92	0.92	0.92	0.92	0.92	0.92	0.92	0.92	0.92	0.92	0.92	0.92
Heavy Vehicles, %	2	2	2	2	2	2	2	2	2	2	2	2
Mvmt Flow	120	7	76	214	11	85	89	211	175	90	209	41
Number of Lanes	0	1	0	1	1	0	1	1	1	1	1	0

Approach	EB	WB	NB	SB
Opposing Approach	WB	EB	SB	NB
Opposing Lanes	2	1	2	3
Conflicting Approach Left	SB	NB	EB	WB
Conflicting Lanes Left	2	3	1	2
Conflicting Approach Right	NB	SB	WB	EB
Conflicting Lanes Right	3	2	2	1
HCM Control Delay	19.7	18.6	15.7	19.5
HCM LOS	C	C	C	C

Lane	NBLn1	NBLn2	NBLn3	EBLn1	WBLn1	WBLn2	SBLn1	SBLn2
Vol Left, %	100%	0%	0%	59%	100%	0%	100%	0%
Vol Thru, %	0%	100%	0%	3%	0%	11%	0%	83%
Vol Right, %	0%	0%	100%	38%	0%	89%	0%	17%
Sign Control	Stop	Stop	Stop	Stop	Stop	Stop	Stop	Stop
Traffic Vol by Lane	82	194	161	186	197	88	83	230
LT Vol	82	0	0	110	197	0	83	0
Through Vol	0	194	0	6	0	10	0	192
RT Vol	0	0	161	70	0	78	0	38
Lane Flow Rate	89	211	175	202	214	96	90	250
Geometry Grp	8	8	8	8	8	8	8	8
Degree of Util (X)	0.213	0.474	0.359	0.491	0.53	0.206	0.222	0.571
Departure Headway (Hd)	8.615	8.099	7.378	8.735	8.906	7.757	8.854	8.216
Convergence, Y/N	Yes	Yes	Yes	Yes	Yes	Yes	Yes	Yes
Cap	419	447	490	412	405	462	405	440
Service Time	6.315	5.799	5.078	6.492	6.66	5.511	6.608	5.97
HCM Lane V/C Ratio	0.212	0.472	0.357	0.49	0.528	0.208	0.222	0.568
HCM Control Delay	13.6	17.9	14.2	19.7	21.3	12.5	14.1	21.4
HCM Lane LOS	B	C	B	C	C	B	B	C
HCM 95th-tile Q	0.8	2.5	1.6	2.6	3	0.8	0.8	3.5

HCM 6th Roundabout
5: Allen Street & Alexander Place

Total Traffic Volumes
Year 2041 - Saturday Peak Hour

Intersection				
Intersection Delay, s/veh	7.8			
Intersection LOS	A			
Approach	EB	WB	NB	SB
Entry Lanes	1	1	1	1
Conflicting Circle Lanes	1	1	1	1
Adj Approach Flow, veh/h	203	310	475	340
Demand Flow Rate, veh/h	207	316	484	347
Vehicles Circulating, veh/h	523	428	221	320
Vehicles Exiting, veh/h	144	277	509	424
Ped Vol Crossing Leg, #/h	0	0	0	0
Ped Cap Adj	1.000	1.000	1.000	1.000
Approach Delay, s/veh	7.4	8.1	8.1	7.4
Approach LOS	A	A	A	A
Lane	Left	Left	Left	Left
Designated Moves	LTR	LTR	LTR	LTR
Assumed Moves	LTR	LTR	LTR	LTR
RT Channelized				
Lane Util	1.000	1.000	1.000	1.000
Follow-Up Headway, s	2.609	2.609	2.609	2.609
Critical Headway, s	4.976	4.976	4.976	4.976
Entry Flow, veh/h	207	316	484	347
Cap Entry Lane, veh/h	809	892	1101	996
Entry HV Adj Factor	0.980	0.980	0.981	0.979
Flow Entry, veh/h	203	310	475	340
Cap Entry, veh/h	793	874	1080	975
V/C Ratio	0.256	0.354	0.439	0.349
Control Delay, s/veh	7.4	8.1	8.1	7.4
LOS	A	A	A	A
95th %tile Queue, veh	1	2	2	2