



**TOWN OF CASTLE ROCK
CONSTRUCTION CONTRACT**

(2023-2024 Denver Basin Aquifer Rehabilitation and Pumping Equipment Replacement Project)

THIS CONSTRUCTION CONTRACT (“Contract”) is made between the **TOWN OF CASTLE ROCK**, a Colorado municipal corporation, 100 N. Wilcox Street, Castle Rock, Colorado 80104 (“Town”) and **APPLIED INGENUITY, LLC**, a Colorado limited liability company, 14920 Harvest Road, Brighton, CO 80603 (“Contractor”).

In consideration of these mutual covenants and conditions, the Town and Contractor agree as follows:

SCOPE OF WORK The Contractor shall execute the entire scope of work described in the Contract (“Work”).

CONTRACT The Contract represents the entire and integrated agreement between the parties hereto and supersedes prior negotiations, written or oral representations and agreements. The Contract incorporates the following Contract Documents. In resolving inconsistencies among two or more of the Contract Documents, precedence will be given in the same order as enumerated.

LIST OF CONTRACT DOCUMENTS

The Contract Documents, except for Modifications issued after execution of this Contract, are:

1. Change Orders
2. Notice to Proceed
3. Construction Contract
4. General Conditions, attached as *Exhibit 1*
5. Where applicable, Davis-Bacon Act Wage Determinations
6. The following Addenda, if any:

Number	Date
1	09/07/2023

7. Special Conditions of the Contract:
8. The following Specifications:
9. The following Drawings/Reports:
10. Notice of Award;
11. Invitation to Bid;
12. Information and Instructions to Bidders;
13. Notice of Substantial Completion;
14. Notice of Construction Completion;
15. Proposal Forms, including Bid Schedules;
16. Performance, and Labor and Material Payment Bonds;
17. Performance Guarantee; and
18. Insurance Certificates.

CONTRACT PRICE. The Town shall pay the Contractor for performing the Work and the completion of the Project according to the Contract, subject to Change Orders as approved in writing by the Town, under the guidelines in the General Conditions. The Town will pay **\$870,353.00** (“Contract Price”), to the Contractor, subject to full and satisfactory performance of the terms and conditions of the Contract. The Contract Price is provisional based on the quantities contained in the Bid attached as *Exhibit 2*. The final



Contract Price shall be adjusted to reflect actual quantities incorporated into the Work at the specified unit prices. The Town has appropriated money equal or in excess of the Contract Price for this work.

COMPLETION OF WORK. The Contractor must begin work covered by the Contract within ten (10) calendar days from the date of the Notice to Proceed, and must complete work within 182 calendar days from and including the date of Notice to Proceed, according to the General Conditions.

LIQUIDATED DAMAGES. If the Contractor fails to complete the Work by the date set for completion in the Contract, or if the completion date is extended by a Change Order, by the date set in the Change Order, the Town may permit the Contractor to proceed, and in such case, may deduct the sum of \$500 for each day that the Work shall remain uncompleted from monies due or that may become due the Contractor. This sum is not a penalty but is a reasonable estimate of liquidated damages.

The parties agree that, under all of the circumstances, the daily basis and the amount set for liquidated damages is a reasonable and equitable estimate of all the Town's actual damages for delay. The Town expends additional personnel effort in administering the Contract or portions of the Work that are not completed on time, and has the cost of field and office engineering, inspecting, and interest on financing and such efforts and the costs thereof are impossible to accurately compute. In addition, some, if not all, citizens of Castle Rock incur personal inconvenience and lose confidence in their government as a result of public projects or parts of them not being completed on time, and the impact and damages, certainly serious in monetary as well as other terms are impossible to measure.

SERVICE OF NOTICES. Notices to the Town are given if sent by registered or certified mail, postage prepaid, to the following address:

TOWN OF CASTLE ROCK
Town Attorney
100 N. Wilcox Street
Castle Rock, CO 80104

With a copy to: Legal@crgov.com

INSURANCE PROVISIONS. The Contractor must not begin any work until the Contractor obtains, at the Contractor's own expense, all required insurance as specified in the General Conditions. Such insurance must have the approval of the Town of Castle Rock as to limits, form and amount. *Certificate of Insurance ("COI") must be submitted along with the executed contract as Exhibit 3.*

RESPONSIBILITY FOR DAMAGE CLAIMS. See Article VI of the General Conditions.

The Contractor also agrees to pay the Town all expenses, including attorney's fees, incurred to enforce this Responsibility for Damage Claim clause.

Nothing in the **INSURANCE PROVISIONS of the General Conditions** shall limit the Contractor's responsibility for payment of claims, liabilities, damages, fines, penalties, and costs resulting from its performance or nonperformance under the Contract.

STATUS OF CONTRACTOR. Contractor has completed the Affidavit of Independent Contractor Status, attached as *Exhibit 4*, and submitted same at the time of execution of this Agreement. The Contractor is performing all work under the Contract as an independent Contractor and not as an agent or employee of the Town. No employee or official of the Town will supervise the Contractor. The Contractor will not supervise any employee or official of the Town. The Contractor shall not represent that it is an employee



or agent of the Town in any capacity. **The Contractor and its employees are not entitled to Town Workers' Compensation benefits and are solely responsible for federal and state income tax on money earned.** This is not an exclusive contract.

THIRD PARTY BENEFICIARIES. None of the terms or conditions in the Contract shall give or allow any claim, benefit, or right of action by any third person not a party to the Contract. Any person, except the Town or the Contractor, receiving services or benefits under the Contract is an incidental beneficiary only.

INTEGRATION. This contract integrates the entire understanding of the parties with respect to the matters set forth. No representations, agreements, covenants, warranties, or certifications, express or implied, shall exist as between the parties, except as specifically set forth in this Contract.

DEFINITIONS. The Definitions in the General Conditions apply to the entire Contract unless modified within a Contract Document.

AMERICANS WITH DISABILITIES ACT. Contractor agrees to ensure that any deliverables, work, services, or equipment developed, designed, constructed or produced pursuant to this Agreement, to include website design services, will comply with all requirements of Title II of the Americans with Disabilities Act and, where applicable, Section 504 of the Rehabilitation Act, the Architectural Barriers Act, and the Colorado Anti-Discrimination Act. To the extent any deliverables, work, services, or equipment developed, designed, constructed or produced pursuant to this Agreement fail to comply with the requirements of this Section, Contractor shall indemnify the Town in accordance with the terms of this Agreement and, at the Town's option, shall re-visit, re-construct, or similar, the non-compliant deliverable, work, service, or equipment, or reimburse the Town for the cost associated with bringing the non-compliance deliverable, work, service or equipment into compliance.

NO DISCRIMINATION IN EMPLOYMENT. The Town is a governmental agency and, therefore, in connection with the performance of Work or Services under this Agreement, Contractor shall not refuse to hire, discharge, promote or demote, or to discriminate in matters of compensation against any person otherwise qualified, solely because of race, color, religion, national origin, gender, age, military status, sexual orientation, gender identity or gender expression, marital status, or physical or mental disability, or any other protected class under Federal or State law; and Contractor shall insert the foregoing provision in any subcontracts hereunder.

ADVERTISING AND PUBLIC DISCLOSURE. Contractor shall not include any reference to this Agreement or goods or services provided pursuant to this Agreement in any of Contractor's advertising or public relations materials without first obtaining the written approval of the Town. Nothing herein, however, shall preclude the transmittal of any information to officials of the Town, including without limitation, the Town Attorney, Town Manager, and the Town Council.

VENUE, CHOICE OF LAW AND DISPUTES. Venue for all legal actions shall lie in the District Court in and for the County of Douglas, State of Colorado, and shall be governed by the laws of the State of Colorado as well as the Charter and Municipal Code, rules, regulations, Executive Orders, and fiscal rules of the Town.

AUTHORITY. The individuals executing this Agreement represent that they are expressly authorized to enter into this Agreement on behalf of the Town and the Contractor and bind their respective entities. This Agreement is executed and made effective as provided above.



LICENSES/TAXES. Contractor affirms it is licensed to do business in the State of Colorado and is in good standing. Further, Contractor shall be solely responsible for paying all applicable taxes associated with or rising out of this Agreement.

CONFIDENTIALITY. Contractor agrees that it shall treat as confidential all information provided by the Town regarding the Town's business and operations. All confidential information provided by the Town hereto shall be used by Contractor solely for the purposes of rendering services or work pursuant to this Agreement and, except as may be required in carrying out the terms of this Agreement, shall not be disclosed to any third party without the prior consent of the Town. The foregoing shall not be applicable to any information that is publicly available when provided or which thereafter becomes publicly available or which is required to be disclosed by any regulatory authority in the lawful and appropriate exercise of its jurisdiction over a party, any auditor of the parties hereto, by judicial or administrative process or otherwise by applicable law or regulation.

ATTACHED EXHIBITS:

- EXHIBIT 1 – TOWN OF CASTLE ROCK CONSTRUCTION CONTRACT GENERAL CONDITIONS
- EXHIBIT 2 – CONTRACTOR'S BID
- EXHIBIT 3 – CONTRACTOR'S CERTIFICATE OF INSURANCE
- EXHIBIT 4 – TOWN OF CASTLE ROCK AFFIDAVIT OF INDEPENDENT CONTRACTOR STATUS

REMAINDER OF PAGE INTENTIONALLY LEFT BLANK

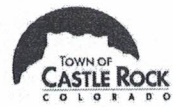

Executed this _____ day of _____, 20__.

ATTEST:

TOWN OF CASTLE ROCK

Lisa Anderson, Town Clerk

Jason Gray, Mayor

Approved as to form:

Approved as to content:

Michael J. Hyman, Town Attorney

Mark Marlowe, Director Castle Rock Water

APPLIED INGENUITY, LLC

By: Geo Martin

Its: President



EXHIBIT 1

TOWN OF CASTLE ROCK CONSTRUCTION CONTRACT GENERAL CONDITIONS

SCOPE: Since the General Conditions are general, some conditions may not apply to a particular Project.

Article 1--DEFINITIONS AND ABBREVIATIONS

- 1.1 Whenever used in the Bidding Documents and Contract Documents, the following terms shall have the following meanings, applicable to both the singular and plural:
 - 1.1.1 **Addenda:** Written changes to the Bidding Documents issued at least two days before the Opening of Bids which modify or interpret the Contract or changes the date set for the Opening of Bids.
 - 1.1.2 **Alternate Bid:** An Alternate Bid is an amount stated in the Bid added to or deducted from the base amount of the Bid when the Town accepts a corresponding change in project scope, materials or method of construction described in the Contract.
 - 1.1.3 **Bid:** The proposal the Bidder submits on the prescribed Bid Forms stating the prices for the Work to be performed.
 - 1.1.4 **Bid Forms:** The Bid Proposal, Bid Bond, Bid Schedule, Bidder's Qualifications and Data, Bidder's Officials Data, Non-Collusion Affidavit of Prime Bidder, and Subcontractors and Related Data.
 - 1.1.5 **Bidder:** The person, partnership, or corporation submitting a Proposal for the performance of the Work covered by the Contract.
 - 1.1.6 **Bidding Documents:** The Invitation to Bid, Bid Forms, Information and Instructions to Bidders, Specifications, Drawings, Sample Forms, Special and General Conditions and Addenda (if any).
 - 1.1.7 **Bonds:** Bid Bonds, Performance, and Labor and Material Payment Bonds or other instruments of security, furnished by the Contractor and its Surety according to the Contract.
 - 1.1.8 **Change Order:** A written modification of the Contract, issued after award to the Contractor, authorizing an addition, deletion or revision in the Work within the general scope of the Contract or authorizing an adjustment in the Contract Price or Contract Time, mutually agreed upon between the Town and the Contractor.
 - 1.1.9 **Town:** The Town of Castle Rock, in the State of Colorado, acting by and through its Mayor, Town Council, Town Manager, or other authorized representative.
 - 1.1.10 **Completion Date:** The date the Contract specifies the Work is to be completed.
 - 1.1.11 **Contract:** The Construction Contract consisting of the Agreement for a Construction Contract and the incorporated Contract Documents.



- 1.1.12 **Contract Coordinator:** The authorized representative of the Town designated to act for the Town in processing the Award of Contracts, maintaining centralized official Contract documentation, providing administrative liaison/coordination, legal liaison/coordination via Town Attorney, and processing of Contract Payment authorizations as approved by the Project Manager.
- 1.1.13 **Contract Documents:** All the documents expressly incorporated into the Contract by the Agreement for Construction Contract, including but not limited to Addenda, Bid Forms, Change Orders, Town Project Final Acceptance, Drawings, General Conditions, Information and Instruction to Bidders, Insurance Certificates, Invitation to Bid, Notice of Award, Notice of Construction Completion, Notice to Proceed, Notice of Substantial Completion, Performance and Labor and Material Payment Bonds, Special Conditions, Supplemental Drawings and Schedules, and Technical Specifications.
- 1.1.14 **Contract Price:** The total monies payable to the Contractor under the terms and conditions of the Contract.
- 1.1.15 **Contract Time:** The number of days stated in the Contract for the completion of the Project.
- 1.1.16 **Contractor:** The person, company, firm or corporation contracting with the Town to construct, erect, alter, install or repair any work or construction project.
- 1.1.17 **Drawings:** The part of the Contract prepared or approved by the Project Manager showing the characteristics and scope of the Work to be performed.
- 1.1.18 **Date of Contract:** The execution date in the Agreement for a Construction Contract.
- 1.1.19 **Day:** In computing time in these Regulations, the time shall be computed by excluding the first and including the last day. If, however, the last day is a Saturday, Sunday or legal holiday, it shall be excluded and the time prescribed or allowed shall conclude on the next business day.
- 1.1.20 **Field Order:** A written order directing a change in the Project issued by the Project Manager to the Contractor during construction based on an emergent need and for no more than 5% of the Project Contingency, so long as within the Project Manager's signing authority. Field Orders shall be routed for appropriate Town-wide signatures within thirty days of execution of such Field Order for formal incorporation into the Contract.
- 1.1.21 **Inspector:** The Town's authorized representative assigned to make detailed inspection of the Work performed by the Contractor.
- 1.1.22 **Notice of Award:** The written notice of the acceptance of the Bid from the Town to the successful Bidder.
- 1.1.23 **Notice of Construction Completion:** The written acknowledgment that construction is complete which starts the warranty period.
- 1.1.24 **Notice of Final Acceptance:** The written acceptance of Work performed under the Contract, following satisfactory conclusion of the warranty period.



- 1.1.25 **Notice to Proceed:** The written notice by the Town to the Contractor authorizing it to proceed with the Work which establishes the Contract commencement and Contract Coordinators.
- 1.1.26 **Notice of Substantial Completion:** The written notice of the date, as certified by the Project Manager, when the Project or a specified part is sufficiently completed, according to the Contract, so the Project or specified part can be used for the intended purposes.
- 1.1.27 **Owner.** The Town; see 1.1.9.
- 1.1.28 **Project:** The undertaking to be performed as provided in the Contract.
- 1.1.29 **Project Manager:** The authorized representative of the Town, known as the Project Manager, assigned to the Project to ensure that all Work is performed according to the terms and conditions of the Contract. Also see Article 10, "Project Manager's Responsibilities."
- 1.1.30 **Shop Drawings:** All Drawings, diagrams, illustrations, brochures, schedules, and other data prepared by the Contractor, a Subcontractor, manufacturer, Supplier or distributor which illustrate how specific portions of the Work will be fabricated or installed.
- 1.1.31 **Special Conditions:** Additions to the General Conditions containing instructions and conditions peculiar to an individual Project.
- 1.1.32 **Specifications:** A part of the Contract Documents consisting of written technical description of materials, equipment, construction systems, standards, and workmanship.
- 1.1.33 **Subcontractor:** Any person, company, firm or corporation, having a subcontract with the Contractor to furnish and perform on-site labor, with or without furnishing materials for the project.
- 1.1.34 **Supplier:** Any person or organization who supplies materials or equipment for the Work, including that fabricated to a special design, but who does not perform labor at the site.
- 1.1.35 **Surety:** The entity which is bound with and for the Contractor for the Performance of the Work and for the Labor and Material Bond.
- 1.1.36 **Unit Price:** An amount stated in the Bid as a price per unit of measurement for materials or services as described in the Contract.
- 1.1.37 **Work:** The construction and services required by the Contract, whether completed or partially completed, including all other labor, materials, equipment and services provided or to be provided by the Contractor to fulfill the Contractor's obligations. The Work may be the whole or a part of the Project.
- 1.2 **Abbreviations:** When the following abbreviations appear in the documents, they are defined as follows:
- | | |
|--------|--|
| AASHTO | American Association of State Highway and Transportation Officials |
| ACI | American Concrete Institute |
| AISC | American Institute of Steel Construction |



ANSI	American National Standards Institute
ASA	American Standards Association
ASCE	American Society of Civil Engineers
ASME	American Society of Mechanical Engineers
ASTM	American Society for Testing and Materials
AWS	American Welding Society
AWWA	American Water Works Association
CDOT	Colorado Department of Transportation
EPA	Environmental Protection Agency
MUTCD	Manual on Uniform Traffic Control Devices
OSHA	Occupational Safety & Health Administration
WW-P	Federal Specifications Prefix

Article 2--PRELIMINARY MATTERS

- 2.1 **Notice to Proceed:** Following the execution of the Contract by the Parties, the Project Manager will give the Contractor written Notice to Proceed with the Work. The Contractor shall begin and continue the Work regularly and without interruption (unless otherwise directed in writing by the Project Manager) with the force necessary to complete the Work within the time stated in the Contract.
- 2.2 **Contractor's Understanding:** The Contractor agrees that, by careful examination, it is satisfied as to the nature and location of the Work, the conformation of the ground, the character, quality, and quantity of the materials to be encountered, the character of equipment and facilities needed before beginning and for the Project, the general and local conditions, and all other matters, which can in any way affect the Work under the Contract. No oral agreement with any officer, agent or employee of the Town either before or after the execution of the Contract shall affect or change any of the terms or obligations contained in the Contract.
- 2.3 **Contractor's Warranty:** The Contractor warrants that it has the knowledge, ability, experience, and expertise to perform the Work competently. The Contractor warrants the capacity of the Contractor's construction plant, personnel, and its ability to complete the Project within the allotted time.
- 2.4 **Contractor's License and Permits:** Contractor, or if applicable Subcontractor, shall be responsible for applying for, and obtaining all Town, County, State and/or Federal licenses and permits required to do the Work. Contractor will not be required to pay for Town permits, with the exception of the Grading, Erosion, and Sediment Control (GESC) permit. All GESC permit fees must be paid by Contractor or Subcontractor as a condition to issuance of such GESC Permit.
- 2.5 **Schedules, Reports, and Records**
- 2.5.1 Before beginning construction, the Contractor shall submit to the Project Manager a Construction Progress Schedule, on a form approved by the Project Manager, showing all Work the Contractor and all Subcontractors will perform. The Project Manager may require the Contractor to substitute a Critical Path Method schedule (CPM), or bar graph type schedule. The Special Conditions will state when a CPM network schedule is required.



- 2.5.2 The schedule shall be in enough detail for the Project Manager to readily determine the Work to be performed each day. When requested by the Project Manager, the Contractor shall update the schedule.
- 2.5.3 Before beginning construction, the Contractor shall give the Project Manager the dates it expects to submit Shop Drawings, manufacturers' details, catalog cuts or other required special detail Drawings and also the dates of beginning manufacture, testing, delivery and installation of special equipment and materials.
- 2.6 **Contractor's Address:** The address in the Bid Proposal is designated as the place to which all communications to the Contractor will be delivered or mailed. The delivery at the listed address, in person or by certified mail, of any notice, letter or other communication to the Contractor, is adequate service upon the Contractor, and the date of the service is the date of delivery.
- 2.7 **Notification of Utility Owners**
- 2.0.0 The Contractor shall cooperate with Utility Owners to mitigate damage whenever the Contractor's work affects their utilities.
- 2.0.1 The Contractor shall not excavate without first notifying the owners, operators or association of owners and operators having underground facilities in the area of such excavation. Notice may be given in person, by telephone or in writing. Notice to an association is notice to each member of the association.
- 2.0.2 Contractor shall give notice of the commencement, extent, and duration of the excavation work at least two business days before beginning Work.
- 2.0.3 If the Project affects fences, landscaping, mailboxes, driveways and other improvements, the Contractor shall notify the affected property owners or occupants IN WRITING at least two business days before beginning Work. The Contractor shall cooperate with the owners or occupants to reduce inconvenience where reasonably possible.
- 2.8 **Department of Revenue Forms**
- 2.0.1 It is the responsibility of the Contractor to apply for a Colorado State Sales and Use Tax Exemption Certificate from the State Dept. of Revenue and to use it when purchasing materials or supplies in connection with the Project.
- 2.0.2 The Town's Tax Exemption Numbers are to be used only when obtaining the Contractor's own Tax Exemption Certificate for each specific Town project:
- a. Federal Tax Exemption Number: 84-6000640
 - b. State of Colorado Tax Exemption Number: 98-05820-0000

Article 3--DRAWINGS AND SPECIFICATIONS

3.1 Intent of Drawings and Specifications

- 3.0.1 In the Drawings and Specifications, the Town intends that the Contractor furnish all superintendence, labor, materials, tools, equipment, supplies, machinery and transportation necessary for the proper execution of the Work unless specifically noted otherwise. The



Contractor shall do all the Work shown on the Drawings and described in the Specifications and all incidental Work reasonably necessary to complete the Project in a substantial and acceptable manner, and to complete fully the Work, ready for use, by the Town.

- 3.0.2 The Contractor shall complete all Work according to the Specifications and Plans, and in compliance with applicable laws of Colorado and ordinances of the Town.
 - 3.0.3 In interpreting the Contract, words describing materials or work having a well-known technical or trade meaning, unless otherwise specifically defined, will be construed according to well-known meanings as recognized by engineers, architects, and the trades.
 - 3.0.4 When the Contract refers to a provision of the General Conditions or another Contract Document, the Contract means the provision as amended or supplemented by other provisions of the Contract.
 - 3.0.5 When the Specifications state the words "as directed," or "as required," or "as permitted," or words of like meaning, it is understood that the direction, requirement or permission of the Project Manager is intended. Similarly, the words **approved, acceptable or satisfactory** shall refer to approval by the Project Manager.
 - 3.0.6 The Contract Documents are intended to be complementary, and Work called for on any Drawing and not mentioned in the Specifications, or Work described in the Specifications and not shown on any Drawing, is included under the Contract as if set forth in both the Specifications and Drawings.
- 3.2 **Copies of Drawings and Specifications Furnished:** The Project Manager will furnish to the Contractor, free of charge, four copies of Drawings and Specifications of the Work. All additional copies will be furnished at reproduction costs.
- 3.3 **Discrepancies in Drawings:** Contractor shall immediately report any discrepancies found between the Drawings and Specifications and site conditions or any errors or omissions in the Drawings or Specifications to the Project Manager, who shall promptly correct such error or omission IN WRITING. Any Work done by the Contractor after discovery of such discrepancies, errors or omissions is done at the Contractor's risk. In all cases, the Project Manager shall decide the intent of the Drawings and Specifications. The decision is final.
- 3.4 **Dimensions:** Figured dimensions shall govern over scaled dimensions.
- 3.5 **Drawings and Specifications at Job Site:** The Contractor shall keep one complete set of all Drawings and Specifications at the job-site, available to the Project Manager or the Manager's representative at all times.
- 3.6 **Shop Drawings**
- 3.6.1 The Contractor shall provide Shop Drawings, settings, schedules, and such other Drawings as may be necessary for the prosecution of the Work in the shop and in the field as required by the Drawings, Specifications or Project Manager's instructions.
 - 3.6.2 The Contractor shall submit for approval four reproducible copies of all Shop Drawings and descriptive data as applicable showing all features not fully detailed on the Contract Plans but essential for a completely coordinated installation.



- 3.6.3 The Town's approval of Shop Drawings indicates only that the type and kind of equipment, general method of construction or detailing are satisfactory, but the Contractor may not construe the approval as a complete check. The Contractor has the responsibility for incorporating into the Work satisfactory materials and equipment meeting the requirements of the Contract Plans and Specifications, the proper dimensions, and the detailing of connections.
- 3.6.4 The review of Shop Drawings is only to check for compliance with the design concept of the Project and general compliance with the Contract Documents. Approval does not indicate the waiver of any contract requirement. Changes in the Work are authorized only by separate written Change Order.
- 3.7 **Record Documents:** The Contractor shall keep one record copy of all Addenda, Change Orders, Drawings, Field Orders, Modifications, and Shop Drawings and Specifications in good order. The Contractor shall record any changes made during construction on the record copies. The Contractor shall make a set of "Record Drawings" by marking this set of prints with all changes from the original Drawings as bid, including all Change Orders, alignment changes, depth changes of underground pipes and utilities, and all other items that are not the same as originally drawn. The Contractor shall keep the Record Drawings up to date as the Project progresses. The Project Manager may require, as a condition of the approval of the monthly progress payment, periodic inspection of the Record Drawings. The Contractor will deliver the Record Drawings to the Project Manager upon completion of the Project before Final Payment.
- 3.8 **Differing Site Conditions**
- 3.8.1 The Contractor shall promptly, before such conditions are further disturbed, notify the Project Manager in writing of:
- 3.8.1.1 Subsurface or latent physical conditions at the job-site differing materially from those indicated in the Contract; or
- 3.8.1.2 Unknown physical conditions at the job-site, of an unusual nature, differing materially from those ordinarily encountered and generally recognized as inherent in Work of the character provided for in the Contract.
- 3.8.2 Upon receipt of written notification from the Contractor of alleged differing site conditions, the Project Manager shall promptly investigate the conditions and if it finds the conditions materially differ, and so cause an increase or decrease in the Contractor's cost of or the time required for performance of any part of the Work under the Contract, an equitable adjustment will be made and the Contract modified in writing as provided for in Article 11 of these General Conditions.
- 3.8.2.1 No claim will be allowed under this Article unless the Contractor has given the written notice required in Article 3.8.1.
- 3.8.2.2 No claim will be allowed under this Article if Final Payment has been made.
- 3.9 **Surveys**



- 3.9.1 The Project Manager shall develop and arrange for all detail surveys necessary. The Contractor assumes full responsibility for construction according to the established lines and grades.
- 3.9.2 The Contractor shall carefully protect all monuments and property markers from disturbance or damage.

Article 4--AVAILABILITY OF RIGHT-OF-WAY

4.1 Acquisition of Right-of-Way

- 4.1.1 Before issuance of Notice to Proceed, the Town shall obtain all land and right-of-way necessary for carrying out and completion of the Work to be performed pursuant to the Contract, unless otherwise mutually agreed.
- 4.1.2 The Town shall provide to the Contractor information which delineates and describes the lands owned and rights-of-way acquired, when necessary. The Contractor shall confine its operations within the areas designated by the Project Manager.

4.2 **Access to Right-of-Way:** The Town will provide right of access to all places necessary for the performance of the Work. Nothing contained in the Contract shall give the Contractor exclusive occupancy of the area provided by the Town. The Town, other Contractors of the Town and utility companies may enter upon or occupy portions of the land furnished by the Town for any purpose, but without unreasonably interfering with the completion of the Project. Joint occupancy or use of the territory shall not be the basis of any claim for delay or damages.

4.3 **State Highway Right-of-Way:** If any part of the Project is within the right-of-way of a roadway under the jurisdiction of the Colorado Division of Transportation (CDOT) the Town shall obtain the necessary permits from CDOT to perform such Work. Town, at its option may assign the responsibility to Contractor to obtain the necessary permits from CDOT to perform such Work. The Contractor shall conform to all the requirements and restrictions indicated on the permit. The Contractor shall restore the area to its original condition, including reseeding, if necessary, at the completion of the Project.

4.4 **Temporary Storage Facilities:** The Contractor may secure at its own expense, and without liability to the Town, use of any additional land that the Contractor may desire for temporary construction activities, and facilities, or storage of materials.

Article 5--BONDS AND INSURANCE

5.1 **Performance Bond and Labor and Material Payment Bond:** The Contractor shall, within ten days after receipt of the Notice of Award, and before the commencement of any operations hereunder execute the Contract and furnish the Town with separate Performance, and Labor and Material Payment Bonds each in a penal sum equal to the amount of the Contract Price, conditioned upon the Contractor's performance of all undertakings, covenants, terms, conditions, and agreements of the Contract, and upon the Contractor's prompt payment to all persons supplying labor and materials in the prosecution of the Work provided by the Contract. The Contractor and a corporate Bonding company, licensed to transact such business in the State of Colorado and acceptable to the Town, shall execute the Bonds. The Contractor bears the expense of these Bonds. If at any time the Surety on such Bonds becomes irresponsible or loses its right to do business in the State of Colorado, the Town may require another Surety, which the Contractor shall furnish



within ten days after receipt of written notice to do so. Evidence of authority of an attorney-in-fact acting for the corporate Surety shall be provided in the form of a certificate as to its power of attorney and to the effect that it is not terminated and remains in full force and effect on the date of the Bonds. The form of the Bonds is subject to the Town's approval.

5.2 Insurance

5.0.6 The insurance requirements contained in the Contract shall not limit or redefine the obligations of the Contractor as provided elsewhere in the Contract.

5.2.2 Contractor agrees to procure and maintain, at its own cost, the following policy or policies of insurance. Contractor shall not be relieved of any liability, claims, demands or other obligations assumed pursuant to the Contract Documents by reason of its failure to procure or maintain insurance, or by reason of its failure to procure or maintain insurance in sufficient amounts, durations, or types.

5.2.2.1 Contractor shall procure and maintain, and shall cause each subcontractor of the Contractor to procure and maintain a policy the minimum insurance coverage listed below. Such coverage shall be procured and maintained with forms and insurers acceptable to the Town. All coverage shall be continuously maintained from the date of commencement of services hereunder. In the case of any claims-made policy, the necessary retroactive dates and extended reporting periods shall be procured to maintain such continuous coverage.

5.3 Insurance Requirements

5.3.1 **General Conditions:** Contractor agrees to secure, at or before the time of execution of this Agreement, the following insurance covering all operations, goods or services provided pursuant to this Agreement. Contractor shall keep the required insurance coverage in force at all times during the term of the Agreement, or any extension thereof, during any warranty period, and for eight (8) years after termination of the Agreement. The required insurance shall be underwritten by an insurer licensed or authorized to do business in Colorado and rated by A.M. Best Company as A-VII or better. Each policy shall require notification to the Town in the event any of the required policies be canceled or non-renewed before the expiration date thereof. Such written notice shall be sent to the Town. Said notice shall be sent thirty (30) days prior to such cancellation or non-renewal unless due to non-payment of premiums for which notice shall be sent ten (10) days prior. If such written notice is unavailable from the insurer, Contractor shall provide written notice of cancellation, non-renewal and any reduction in coverage to the Town by certified mail, return receipt requested within three (3) business days of such notice by its insurer(s). Contractor shall be responsible for the payment of any deductible or self-insured retention. The insurance coverages specified in this Agreement are the minimum requirements, and these requirements do not lessen or limit the liability of the Contractor. The Contractor shall maintain, at its own expense, any additional kinds or amounts of insurance that it may deem necessary to cover its obligations and liabilities under this Agreement. All commercial and automobile liability policies shall have the following additional provisions:

- Severability of interests or separation of insureds provision;
- Provision that coverage is primary and non-contributory with other coverage maintained by the Town;
- The underlying Agreement is an "insured contract" under the policy;



- Defense costs shall be outside the policy limits for liability coverage.
- 5.3.2 **Proof of Insurance:** Contractor may not commence services or work relating to the Agreement prior to placement of coverages required under this Agreement. Contractor certifies that the certificate of insurance attached as *Exhibit 3*, preferably an ACORD form, complies with all insurance requirements of this Agreement. The Town's acceptance of a certificate of insurance or other proof of insurance that does not comply with all insurance requirements set forth in this Agreement shall not act as a waiver of Contractor's breach of this Agreement or of any of the Town's rights or remedies under this Agreement. Each certificate shall identify the Project and shall provide that coverage afforded under the policies shall not be cancelled, terminated or materially changed until at least 30 days prior written notice has been given to the Town. If the words "endeavor to" appear in the portion of the certificate addressing cancellation, those words shall be stricken from the certificate by the agent(s) completing the certificate. The Town may require additional proof of insurance, including but not limited to policies and endorsements.
- 5.3.3 **Additional Insureds:** For Commercial General Liability, Automobile Liability, Contractors Pollution Liability (if required) and Excess Liability/Umbrella (if required), Contractor and subcontractor's insurer(s) shall include the Town, its elected and appointed officials, officers, employees, agents and volunteers acting within the course and scope of their duties for the Town as additional insured.
- 5.3.4 **Waiver of Subrogation:** For all coverages required under this Agreement, with the exception of Professional Liability - if required, Contractor's insurer shall waive subrogation rights against the Town its elected and appointed officials, officers, employees, agents and volunteers acting within the course and scope of their duties for the Town.
- 5.3.5 **Subcontractors and Subconsultants:** All subconsultants, subcontractors, independent contractors, suppliers or other entities providing goods or services required by this Agreement shall be subject to all of the requirements herein. Contractor shall require all of its subcontractors and subconsultants of any tier to provide insurance coverage in types and amounts required by the Contractor, but in amounts of at least \$1,000,000 Commercial General Liability, Business Automobile Liability insurance of \$1,000,000 combined single limit, statutory Workers' Compensation coverage, and \$1,000,000 professional liability for any subcontractor performing design or engineering work. Contractor agrees to provide proof of insurance for all such subcontractors, subconsultants, independent contractors, suppliers or other entities upon request by the Town.
- 5.3.6 **Workers' Compensation and Employer's Liability Insurance:** Contractor shall maintain the coverage as required by statute for each work location and shall maintain Employer's Liability insurance with minimum limits of \$100,000 per occurrence for each bodily injury claim, \$100,000 per occurrence for each bodily injury caused by disease claim, and \$500,000 aggregate for all bodily injuries caused by disease claims.
- 5.3.7 **Commercial General Liability:** Contractor shall maintain a Commercial General Liability insurance policy with minimum limits of \$1,000,000 for each occurrence and \$2,000,000 products and completed operations aggregate, and \$2,000,000 general aggregate (per project). The policy shall provide coverage for all claims for bodily injury, property damage (including loss of use), products and completed operations, and contractual liability.



- 5.3.8 **Business Automobile Liability:** Contractor shall maintain Business Automobile Liability, or its equivalent, with minimum limits of \$1,000,000 combined single limit applicable to all owned, hired and non-owned vehicles used in performing services under this Agreement. If transporting wastes, hazardous material, or regulated substances, Contractor shall carry a pollution coverage endorsement and an MCS 90 endorsement on their policy. Transportation coverage under the Contractors Pollution Liability policy shall be an acceptable replacement for a pollution endorsement to the Business Automobile Liability policy.
- 5.3.9 **Builder's Risk or Installation Floater:** Contractor shall maintain limits equal to the completed value of the project. Coverage shall be written on an all risk, replacement cost basis including coverage for soft costs, flood and earth movement, if in a flood or quake zone, and, if applicable, equipment breakdown including testing. The Town, Contractor, and subcontractors shall be Additional Named Insureds under the policy. Policy shall remain in force until acceptance of the project by the Town.
- 5.3.10 **Contractor's Pollution Liability:** Contractor shall maintain minimum limits of \$1,000,000 per occurrence and \$2,000,000 policy aggregate. Policy to include bodily injury; property damage including loss of use of damaged property; defense costs including costs and expenses incurred in the investigation, defense or settlement of claims; and clean-up costs. Policy shall include a severability of interest or separation of insured provision (no insured vs. insured exclusion) and a provision that coverage is primary and non-contributory with any other coverage or self-insurance maintained by the Town.
- 5.3.11 **Additional Provisions:**
- 5.3.11.1 For claims-made coverage: The retroactive date must be on or before the contract date or the first date when any goods or services were provided to the Town, whichever is earlier
- 5.3.11.2 Contractor shall advise the Town in the event any general aggregate or other aggregate limits are reduced below the required per occurrence limits. At their own expense, and where such general aggregate or other aggregate limits have been reduced below the required per occurrence limit, the Contractor will procure such per occurrence limits and furnish a new certificate of insurance showing such coverage is in force.

Article 6—INDEMNIFICATION

- 6.1 **Responsibility for Damage Claims:** The Contractor shall indemnify, save harmless, and defend the Town, its officers and employees, from and in all suits, actions or claims of any character brought because of: any injuries or damage received or sustained by any person, persons or property because of operations for the Town under the Contract; the Contractor's failure to comply with the provisions of the Contract; the Contractor's neglect of materials while constructing the Work; because of any act or omission, neglect or misconduct of the Contractor; because of any claims or amounts recovered from any infringements of patent, trademark, or copyright, unless the design, device, materials or process involved are specifically required by Contract; from any claims or amount arising or recovered under the "Workers' Compensation Act," by reason of the Contractor's failure to comply with the act; pollution or environmental liability; or any failure of the Contractor to comply with any other law, ordinance, order or decree. The Town may retain so much of the money due the Contractor under the Contract, as the Town considers necessary for such purpose, for the Town's use. If no money is due, the Contractor's Surety may be held until such suits, actions,



claims for injuries or damages have been settled. Money due the Contractor will not be withheld when the Contractor produces satisfactory evidence that it and the Town are adequately protected by public liability and property damage insurance.

- 6.1.1 The Contractor also agrees to pay the Town all expenses incurred to enforce this "Responsibility for Damage Claim" agreement and if the insurer of the Contractor fails to provide or pay for the defense of the Town of Castle Rock, its officers and employees, as additional insured, the Contractor agrees to pay for the cost of that defense.
- 6.1.2 Nothing in the **INSURANCE PROVISIONS** shall limit the Contractor's responsibility for payment of claims, liabilities, damages, fines, penalties, and costs resulting from its performance or nonperformance under the Contract.
- 6.1.3 This indemnification obligation shall survive the expiration or termination of this Contract.

Article 7--CONTRACTOR'S RESPONSIBILITIES

7.1 Control of the Work

- 7.1.1 When the Contractor is not present on the Project it shall have a Superintendent or other representative acceptable to the Town present who shall, during the absence of the Contractor, be its representative and have immediate charge of the Project. The Superintendent or representative shall have the Contractor's authority to act in its absence.
- 7.1.2 Any person employed on the Project who fails, refuses or neglects to obey the Superintendent or Contractor's other designated representative, shall, upon the order of the Project Manager, be at once removed from the Project and not again employed on any part of the Project.

7.2 General Use of Subcontractors

- 7.2.1 The Contractor may utilize the services of specialty Subcontractors on those parts of the Work which, under normal contracting practices, are performed by specialty Subcontractors.
- 7.2.2 The Contractor shall not sublet or subcontract any portion of the Work to be done under the Contract until approval of such action has been obtained from the Town.
- 7.2.3 The Contractor is fully responsible to the Town for the acts and omissions of its Subcontractors, and of persons either directly or indirectly employed by them.
- 7.2.4 Nothing contained in the Contract creates any contractual relationship between any Subcontractor and the Town.
- 7.2.5 The Contractor shall put appropriate provisions in all Subcontracts relative to the Work to bind Subcontractors to the terms of the Contract insofar as applicable to the Work of Subcontractors, and to give the Contractor the same power to terminate any Subcontractor that the Town may exercise over the Contractor.
- 7.2.6 The Contractor shall make available to each proposed Subcontractor, before the execution of the subcontract agreement, copies of the Contract Documents to which the Subcontractor



will be bound, and, upon written request of the Subcontractor, identify to the Subcontractor terms and conditions of the proposed subcontract agreement which may be at variance with the Contract Documents. Subcontractors shall similarly make copies of applicable portions of such documents available to their respective proposed Sub-Subcontractors.

7.3 **Materials and Equipment Furnished by the Contractor**

- 7.3.1 The Contractor shall furnish and pay the cost of all of the necessary materials not furnished by the Town, all the superintendence, labor, tools, equipment, installation, maintenance, dismantling and removal of materials, supplies, temporary facilities, machinery and transportation. The Contractor shall perform all the work required for the construction of all structures listed and itemized under the Bid Schedule of the Bid in strict accordance with the plans, Specifications and requirements and any amendments thereto and supplemental plans and Specifications hereafter approved.
- 7.3.2 Unless otherwise provided for in the Specifications, all workmanship, equipment, materials, and articles incorporated in the Project are to be the best of their respective kinds, new and undamaged.
- 7.3.3 Materials, supplies or equipment to be incorporated into the Project shall not be purchased by the Contractor or any Subcontractor subject to chattel mortgage or under a conditional sales contract or other agreement by which an interest is retained by the seller.
- 7.3.4 The Contractor shall furnish the Project Manager, for the Manager's approval, the name of the manufacturer of machinery and other equipment for materials the Contractor contemplates incorporating in the Project. The Contractor shall also furnish information on capacities, efficiencies, sizes, etc., and other information as may be required by the Project Manager. The Contractor shall submit samples for approval when requested. Machinery, equipment, materials, and articles installed or used without the Project Manager's approval are at the risk of subsequent rejection.
- 7.3.5 The Contractor shall give the Project Manager three copies of all shop manuals, operating manuals, parts lists, classifications, catalog cuts, Specifications, warranties and guarantees for all equipment and machinery installed.
- 7.3.6 **Consideration of a product as an "equal" by the Project Manager may require that the manufacturer of such product furnish guarantees that extend beyond the usual product warranty time.** The refusal of a manufacturer to provide such guarantees is sufficient reason for rejecting the product.

7.4 **Patents and Copyrights**

- 7.4.1 The Contractor shall provide a suitable legal agreement with the patentee giving the Contractor the right to use any design, device, material, or process covered by letters patent or copyright, in the construction of the Project when the use has not been specified or required by the Drawings and Specifications. The Contractor shall file a copy of this agreement with the Town, if requested. The Contractor and the Surety shall indemnify, defend and save harmless the Town from all claims for infringements on patented design, devices, material, process or any trademark or copyright during the prosecution or after the completion of the Project.



7.4.2 If any design, device, material, process or product of a particular manufacturer covered by letters patent or copyright is specified for use by the Drawings and Specifications, the Town is responsible for any claims for infringement by reason of the use of such design, device, material, process or product of a particular manufacturer; but the Contractor shall pay any royalties or license fees required.

7.5 Existing Utilities

7.5.1 The Town has collected and shown on the Drawings available information on the location of existing underground, surface and overhead structures and utilities. However, the Town does not guarantee the results of the investigations are accurate or complete. It is the Contractor's responsibility to verify all locations of existing structures and utilities shown on the Drawings and to ascertain whether any other structures and utilities exist.

7.5.2 The Contractor shall support, and protect from injury, existing power lines, telephone lines, water mains, gas mains, sewers, cables, conduits, ditches, curbs, walks, pavements, driveways, and other structures in the vicinity of the Project which are not authorized to be removed until completion of the Project.

7.6 Coordination with Utilities Departments

7.6.1 The Contractor shall always coordinate its Work with the Town of Castle Rock Utilities Department. If it becomes necessary to close portions of any water or sewer system due to construction operations, a minimum of 48 hours notification shall be given the Utilities Department and whenever possible one week's notice should be given. It is the Contractor's responsibility to ensure continuity of the utilities.

7.6.2 All water from Town owned utilities required for the Project will be provided at the Contractor's expense.

7.7 Laws and Ordinances

7.7.1 The Contractor shall perform all obligations under the Contract in strict compliance with all federal, state, and municipal laws, rules, statues, charter provisions, ordinances, and regulations, applicable to the performance of the Contractor under the Contract.

7.7.2 The Contractor shall obtain all other permits and licenses required in the prosecution of the Work.

7.7.3 IT IS UNLAWFUL AND UNETHICAL FOR ANY PERSON TO OFFER, GIVE OR AGREE TO GIVE ANY TOWN EMPLOYEE, TOWN OFFICIAL OR FORMER TOWN EMPLOYEE, OR FOR ANY TOWN EMPLOYEE, TOWN OFFICIAL OR FORMER TOWN EMPLOYEE TO SOLICIT, DEMAND, ACCEPT OR AGREE TO ACCEPT FROM ANOTHER PERSON, A GRATUITY OR AN OFFER OF EMPLOYMENT IN CONNECTION WITH ANY DECISION, APPROVAL, DISAPPROVAL, RECOMMENDATION OR PREPARATION OF ANY PART OF A PROGRAM REQUIREMENT OR A PURCHASE REQUEST, INFLUENCING THE CONTENT OF ANY SPECIFICATION OR PROCUREMENT STANDARD, RENDERING OF ADVICE, INVESTIGATION, AUDITING OR IN ANY OTHER ADVISORY CAPACITY IN ANY PROCEEDING OR APPLICATION, REQUEST FOR RULING, DETERMINATION, CLAIM OR CONTROVERSY, OR OTHER PARTICULAR



MATTER, PERTAINING TO ANY PROGRAM REQUIREMENT OR A CONTRACT OR SUBCONTRACT, OR TO ANY SOLICITATION OR PROPOSAL THEREFOR.

- 7.7.4 IT IS UNLAWFUL AND UNETHICAL FOR ANY PAYMENT, GRATUITY OR OFFER OF EMPLOYMENT TO BE MADE BY OR ON BEHALF OF A SUBCONTRACTOR UNDER A CONTRACT TO THE PRIME CONTRACTOR OR HIGHER TIER SUBCONTRACTOR OF ANY PERSON ASSOCIATED THEREWITH, AS AN INDUCEMENT FOR THE AWARD OF A SUBCONTRACT OR ORDER.

7.8 **Protection of Persons**

- 7.8.1 The Contractor is responsible for the health and safety of each and every person on or at the Work site. The Contractor shall take all necessary and reasonable precautions and actions to protect all such persons from injury, death or loss. The Contractor shall furnish, erect, and maintain at its own expense all necessary precautions for the protection of the Work and safety of the public through and around its construction operations.
- 7.8.2 Contractor shall prepare and implement a safety program complying with all of the requirements in this Section. Prior to the start of construction, Contractor shall provide the safety program to the Project Manager.
- 7.8.3 Prior to the start of construction, the Contractor shall provide the Project Manager with a statement signed by the Contractor's Superintendent that all Contractor Personnel have been or will be briefed on the Contractor's safety program prior to being allowed on the Work site.
- 7.8.4 It is a condition of the Contract, and the Contractor shall make a condition of each Subcontract entered into pursuant to the Contract, that the Contractor and any Subcontractor shall not require any laborer, mechanic or other person employed in performance of the Contract to work in surroundings or under working conditions which are unsanitary, hazardous or dangerous to health or safety. The Contractor shall comply with all applicable safety rules and regulations adopted by the United States Department of Labor Occupational Safety and Health Administration (OSHA), the Industrial Commission of the State of Colorado or the Town of Castle Rock, whichever is most restrictive. The Town assumes no duty to ensure that the Contractor follows the safety regulations issued by OSHA or the State of Colorado.
- 7.8.5 The Town shall have the right at any time to request a safety compliance review of the Contractor's and its Subcontractor's safety policies, practices, and procedures. The Contractor shall provide to the Project Manager a complete copy of any OSHA correspondence, report, warning, citation, directive or notice within twenty-four (24) hours after it is received. The Contractor shall also provide the Project Manager a copy of any Contractor replies to any OSHA correspondence, report, warning, citation, directive or notice. This submittal is for informational purposes only and shall not alter the Contractor's responsibilities for safety of the Work site.
- 7.8.6 The Contractor shall provide written notice of any report of injury on the Work site to the Project Manager within forty-eight (48) hours after Contractor becomes aware of same. In addition, the Contractor shall provide verbal notice of the injury to the Project Manager immediately following the report of the injury. Contractor shall thereafter provide a copy of any investigation into the injury and a written statement of resolution of the injury, which



should include but is not limited to, the cause of the injury and remediation steps the Contractor will take to prevent another similar injury.

- 7.8.7 The Contractor shall employ at the Work site a responsible qualified person whose duties shall include the protection of persons and property and the administration of the Contractor's safety program. This person must have safety training, a working knowledge of safety requirements, and experience administering safety programs. The Contractor shall provide the Project Manager with this person's name prior to the start of construction.
- 7.8.8 For operations involving trenching, excavation or any other underground construction, the Contractor's attention is specially directed to and its Work shall conform to the Construction Safety and Health Regulations, Part P Subparagraph 1926.650-653 by OSHA, latest revision.
- 7.8.9 The Contractor shall provide all necessary protective devices and safety precautions. Such devices and precautions may include but are not limited to: posting of danger signs warning against hazards such as, but not limited to, hoists, well holes, elevator hatchways, scaffolding, openings, stairways, trip and fall hazards and falling materials; placement of warning flares; equipment back-up alarms; installation of barricades; promulgation and application of safety regulations and employment of safety personnel and guards. Signs will not be considered to be an adequate substitute for physical protective barriers. The costs of all protective devices and the planning and implementing of safety precautions are considered to be included in the Contract Amount.
- 7.8.10 This Section shall be interpreted in its broadest sense for the protection of persons and property, and no act or omission to act by the Town, its officers, employees or agents, or by any consultant shall relieve the Contractor of its obligations and duties hereunder.

7.9 **Protection of Property**

- 7.9.1 The Contractor shall continuously and adequately protect the Work from damage, injury or loss arising in connection with the Contract. It shall repair or replace at its expense any such damage, injury or loss, except such as may be directly due to error in the Contract or caused by agents or employees of the Town. It shall provide and maintain at its expense all passageways, barricades, guard fences, lights, and other protection facilities required by public authority or local conditions.
- 7.9.2 The Contractor is responsible for protection of all public and private property on and adjacent to the site of the Work. It shall use every precaution necessary to prevent damage to curbs, sidewalks, driveways, trees, shrubs, sod, mailboxes, fences, and other private and public improvements. It shall protect carefully from disturbance or damage all land monuments and property markers until an authorized agent has witnessed or otherwise referenced their locations, and shall not remove them until directed.
- 7.10 **Protection of Historical Sites:** When the Contractor's excavating operations encounter remains of prehistoric people's dwelling sites or artifacts of historical or archeological significance, the Contractor shall temporarily discontinue the operations, and immediately advise the Project Manager. The Project Manager will contact archeological authorities to determine the disposition of the items in question. When directed, the Contractor shall excavate the site in such a manner as to preserve the artifacts encountered and remove them for delivery to the custody of the proper authorities. Such excavation is considered, and paid for, as extra Work.



7.11 Responsibility to Repair

- 7.11.1 Should any existing property be damaged, the Contractor shall immediately notify the owner of such property. Unless authorized in writing by the owner of the property or directed by the Project Manager, the Contractor shall not attempt to make repairs. Written authorization from the owner to make repairs must be so worded as to save the Town harmless from any responsibility whatsoever relative to the sufficiency of the repairs. The Contractor shall give the Project Manager a copy of the written authorization to make repairs.
- 7.11.2 When any direct or indirect damage or injury is done to any public or private property or utility by or on account of any act, omission, neglect or misconduct in the execution of the Work, the Contractor shall restore the damaged property at its own expense to a condition equal to or better than that existing before such damage or injury.
- 7.11.3 The Contractor shall replace any materials and equipment lost, stolen, damaged or otherwise rendered useless during the performance of Work on the Project.

7.12 Traffic Control

- 7.12.1 The Contractor shall arrange Work to disrupt traffic as little as possible. All traffic Control Devices used shall conform to the latest edition of the Manual of Uniform Traffic Control Devices, (MUTCD). Except as otherwise permitted, two-way traffic shall be maintained at all times in public roadways. At least 7 days before starting any Work in Town right-of-way, the Contractor shall submit a detailed traffic control plan for review from the Public Works Department, with a copy to the Police Department. The approval shall establish the requirements for closures related to the number of lanes and time of day lanes or streets may be closed. The Traffic Control Plan (TC Plan) shall include the name of the contractor, the name and phone number of the person responsible for the traffic control, the date for beginning and ending construction activity and hours of operation expected. The TC Plan should show the widths of streets involved, traffic lanes, the size and location of the Work area with distances from the curb, distance to the nearest intersection and the type and location of traffic control devices. No changes to the TC Plan shall be permitted without prior approval by the Public Works Director.
- 7.12.2 The Contractor shall furnish and maintain all necessary signs, barricades, lights, and flaggers necessary to control traffic and provide for safety of the public, all in compliance with the MUTCD with subsequent revisions and additions, and to the satisfaction of the Public Works Director.
- 7.12.3 Whenever a police officer is necessary for traffic control, the Contractor shall hire and pay a uniformed off-duty police officer with authority in the Town to direct traffic. The police department will determine the rate of pay for the officers.
- 7.12.4 The Contractor shall make its Traffic Control plans in concurrence with the Town requirements.

7.13 Sanitary Regulations



- 7.13.1 The Contractor is responsible for providing proper health and sanitation facilities for its employees, in compliance with any rules and regulations of the State Board of Health or any other bodies having jurisdiction.
- 7.13.2 The Contractor shall always provide an abundant supply of safe drinking water for its employees and shall give orders against the drinking of any water known to be unsafe in the vicinity of the Project.
- 7.13.3 At convenient places, the Contractor shall provide fly-proof outside toilets which are to be maintained in a sanitary condition. Toilets shall not be permitted in any reservoir area and shall not be permitted where they may pollute a water supply.

7.14 **Pollution Control**

- 7.14.1 The Contractor shall comply with all applicable Federal and State laws, orders, and regulations concerning the control, prevention, and abatement of water pollution and air pollution in all operations pertaining to the Contract whether on right-of-way provided by the Town or elsewhere.
- 7.14.2 The Contractor shall use construction methods that prevent release, entrance or accidental spillage of solid matter, contaminants, debris, and other objectionable pollutants and wastes including, but not restricted to refuse, garbage, cement, concrete, sewage effluent, industrial waste, radioactive substances, oil and other petroleum products, aggregate processing tailings, mineral salts, and thermal pollution. Non-regulated solid wastes shall be disposed of by methods approved under applicable laws and regulations, including, the Resource Conservation and Recovery Act (RCRA), Subtitle D, as administered by Colorado and local Health Departments and the EPA. Contaminated and hazardous materials are regulated by RCRA, Subtitles C and D. The Contractor shall notify the Colorado Department of Health, local Health Departments, and Town Fire Departments if suspect materials are encountered.
- 7.14.3 The Contractor shall utilize methods and devices that are reasonably available to control, prevent, and otherwise minimize atmospheric emissions or discharges of air contaminants including dust in its construction activities and operation of equipment.
- 7.14.4 **The Contractor shall not emit dust into the atmosphere during any operations, including but not limited to:** grading; excavating; manufacturing, handling or storing of aggregates; trenching; or cement or pozzolans. The Contractor shall use the necessary methods and equipment to collect, deposit, and prevent dust from its operations from damaging crops, orchards, fields or dwellings or causing a nuisance to persons. The Contractor is liable for any damage resulting from dust.
- 7.14.5 The Contractor may not operate equipment and vehicles with excessive emission of exhaust gases due to improper mechanical adjustments, or other inefficient operating conditions, until repairs or adjustments are made.
- 7.14.6 Burning trash, rubbish, trees, brush or other combustible construction materials is not permitted.
- 7.14.7 De-watering for structure foundations or earthwork operations adjacent to or encroaching on lakes, streams or water courses shall be done in a manner which prevents muddy water



and eroded materials from entering the lakes, streams or water courses, by construction of intercepting ditches, bypass channels, barriers, settling ponds or by other approved means. Excavated materials may not be deposited or stored in or alongside lakes or water courses where they can be washed away by high water or storm runoff.

7.14.8 The Contractor may not allow waste water from aggregate processing, concrete batching or other construction operations to enter lakes, streams, water courses or other surface waters without turbidity control methods such as settling ponds, gravel-filter entrapment dikes, approved flocculation processes that are not harmful to fish, recirculation systems for washing of aggregates or other approved methods. Any waste waters discharged into surface waters shall conform to applicable discharge standards of the Colorado Department of Health and the Federal Government.

7.15 Cleaning Up and Restoration

7.15.1 The Contractor shall clean up all refuse or scrap materials so the site presents a neat, orderly, and workmanlike appearance at all times.

7.15.2 Upon completion of the Project, and before Final Inspection, the Contractor shall remove from the construction site and any occupied adjoining property all plants, buildings, refuse, unused materials, forming lumber, sanitary facilities, and any other materials and equipment that belong to the Contractor or its Subcontractors.

7.15.3 The Town may clean up and restore the construction site satisfactorily when the Contractor fails to do so. Any costs the Town incurs will be deducted from the Final Payment due the Contractor.

Article 8--OTHER WORK

8.1 The Town reserves the right to award other Contracts in connection with the Project. The Contractor shall cooperate with and afford other contractors' reasonable opportunity for the introduction and storage of their materials and the execution of their Work, and shall coordinate its Work with theirs.

Article 9--TOWN'S RESPONSIBILITIES

9.1 The Town will furnish the data required by the Contract and will make payments to the Contractor as provided by these General Conditions.

Article 10--PROJECT MANAGER'S RESPONSIBILITIES

10.1 The Project Manager is designated by the Town to exercise all authority on its behalf under the Contract and to see that the Project is completed according to its terms and conditions. The Project Manager may assume exclusive control of the performance of the Contractor whenever such performance is located in or upon the Town's property. The Project Manager will furnish all explanations, directions, stakes or markers, and inspections necessary to carry out and complete the Project.

10.2 Lines and Grades

10.2.1 The Contractor shall survey and stake as needed to complete project.



- 10.2.2 The Project Manager may appoint a Surveyor who will furnish all lines and grades. The Contractor shall give assistance, as required by the Surveyor, to aid in the staking, including clearing, improving access, exploratory excavations, and suspending operations to permit the Surveyor to perform its Work.
- 10.2.3 The Contractor shall give notice to the Surveyor at least three full days before initial lines and grades are needed. Thereafter, the Contractor shall give the Surveyor notice at least one full day before additional line and grade stakes are needed. The Project Manager is not responsible for providing lines and grades until the Contractor meets this Article's notice requirements.
- 10.2.4 The Contractor shall preserve all stakes, bench marks, and any other survey points. If they are destroyed by the Contractor or its employees, the Contractor shall pay for their replacement.

10.3 **Inspection**

- 10.3.1 The Project Manager shall appoint Inspectors to inspect the Project. Inspection may extend to all or any part of the Project. The Inspectors are not authorized to alter the provisions of the Drawings or Specifications or to delay the fulfillment of the Contract by failure to inspect materials and Work with reasonable promptness.
- 10.3.2 An Inspector has authority to reject defective materials and to suspend any Work that is being done improperly subject to the final decision of the Project Manager.
- 10.3.3 The Contractor shall give the Project Manager due and timely notice of readiness when the Project is to be inspected, tested or approved by someone other than the Inspector. The Contractor shall give the Project Manager required certificates of inspection, testing or approval. Inspection, tests or approvals by the Project Manager or others does not relieve the Contractor from its obligations to perform the Work according to the requirements of the Contract.
- 10.3.4 If the Project Manager considers it necessary or advisable that previously completed or covered Work be inspected or tested, the Contractor shall uncover, expose or otherwise make the Work available to the Project Manager for inspection and testing. The Contractor shall furnish all tools, labor, material, and equipment necessary to make the Work available. If the Project Manager finds the Work defective, the Contractor shall pay for the cost of satisfactory reconstruction and making the Work available. However, if the Work is not found defective, the Contractor will be allowed an increase in the Contract Price and/or an extension of the Contract Time for costs and time directly attributable to making the Work available and for reconstruction.
- 10.3.5 If the Contractor's operations require inspecting, testing or surveying to be done outside normal working hours or on Town holidays, it shall be at the Contractor's expense.

10.4 **Stop Work Order**

- 10.4.1 The Project Manager has the authority to suspend Work on the Project either in whole or in part, for as long as the Project Manager deems necessary due to:

X Unsuitable weather;



- X Faulty workmanship;
- X Improper superintendence;
- X Contractor's failure to carry out orders or to perform any provision of the Contract;
- X Conditions which may be considered unfavorable for the prosecution of Work on the Project; or
- X Work being carried on in an unsafe manner.

10.4.2 If it is necessary to stop work for an indefinite period, the Contractor shall, if directed by the Project Manager, store all materials in such a manner that they will not become an obstruction or become damaged in any way. The Contractor shall take every precaution to prevent damage to or deterioration of the Work, providing suitable drainage and erecting temporary structures where necessary.

10.4.3 The Project Manager will put the Stop Work order in writing and the Contractor may not proceed with Work on the suspended portion of the Project until notified in writing by the Project Manager.

10.5 Disputes

10.5.1 If the Contractor considers any Work directed by the Town to be outside the Contract requirements, or if it considers any ruling of the Project Manager to be unfair, it shall immediately ask for a written instruction or decision and shall perform the Work in conformance with the Project Manager's ruling. If the Contractor considers such instructions unsatisfactory, it shall file a written protest with the Project Manager within ten days after their receipt.

10.5.2 All claims, disputes and other matters in question arising out of or relating to the Contract shall be submitted to the Project Manager before the Contractor can begin litigation.

Article 11--CHANGES

11.1 General

11.1.1 The Town may make alterations to the Project without the consent of the Surety at any time during the Work. The Contractor shall perform the Work as changed, as if originally specified. The alterations do not invalidate the Contract in any way.

11.1.2 The Project Manager may, at any time, without notice to the Surety, by written notice to the Contractor, make any change in the Work to be performed within the general scope of the Contract, including but not limited to changes:

- X In the Specifications (including Drawings and designs);
- X In the method or manner of the performance of the Work;
- X In facilities, equipment, materials, services or site furnished by the Town; or
- X Directing acceleration in the performance of the Work.

11.1.3 Any other written order or verbal order (which terms as used in this Article shall include direction, instruction, interpretation or determination) from the Project Manager, which causes the change, will be treated as a Change Order under this Article, provided that the Contractor gives the Project Manager written notice stating the date, circumstances, and source of the order and that the Contractor regards the order as a Change Order.



- 11.1.4 The Contractor may not treat any order, statement or conduct of the Project Manager as a change under this Article nor become entitled to an equitable adjustment in the Contract Price or Performance Time, except as provided in this Article.
- 11.1.5 If any change under this clause causes an increase or decrease in the Contractor's cost or the time required for the performance of any part of the Work under the Contract, whether or not changed by any order, an equitable adjustment will be made and the Contract modified in writing accordingly.
- 11.1.6 Claims for changes in the Contract Price or Contract Time of Performance will not be considered after the Final Payment has been made.
- 11.2 **Compliance with §24-91-103.6:** Notwithstanding any other language in this contract, the issuance of any Change Order or other form of order or directive by the Town requiring additional compensable work to be performed which will cause the Contract Price to **exceed** the amount appropriated for the Work is prohibited unless the Contractor is given written assurance by the Town that lawful appropriations to cover the costs of the additional work have been made or unless the Contract contains a remedy granting provision.
- 11.3 **Field Orders:** The Project Manager may make changes in the details of the Project at any time, by issuing a Field Order. The Contractor shall proceed with the performance of any changes in the Project ordered by the Project Manager. If the Contractor believes that such Field Order entitles it to a change in Contract Price or Time, or both, it shall give the Project Manager written notice within ten days after the receipt of the Field Order. Thereafter, the Contractor shall document the basis for the change in Contract Price or Time within thirty days.
- 11.4 **Change Orders**
- 11.4.1 Changes in the Contract Price are authorized only by Change Orders. Changes in contract time may be made by Change Order or by other appropriate written authorization.
- 11.4.2 Any difference in cost from Change Orders shall be added to or deducted from the amount of the Contract, as the case may be. Adjustments in the amounts to be paid to the Contractor on account of changed Work will be determined by one of the following methods in the order listed:
- X Unit Prices submitted in the Bid Schedule;
 - X Negotiated Unit Prices; and
 - X Negotiated lump sum.
- 11.5 **Extras and Force Account Work**
- 11.5.1 The Contractor shall perform any Work and furnish materials and equipment necessary or desirable for proper completion of the Contract if the Project Manager believes it necessary to order Work or materials or equipment which, in the Project Manager's opinion, are not susceptible to classification under the Unit Price items named in the Bid Schedule, and are not included in any lump sum bid item. The Project Manager will order such labor, material and equipment in writing before the extra Work is started. The labor, material and equipment will be classed as extra Work. The Town will not pay for extra Work unless the Town orders in extra work in writing. All claims for extra Work shall be submitted to the Project Manager, supplemented by any data the Project Manager requires.



- 11.5.2 Extra Work and Work involving a combination of increases and decreases in the Work will ordinarily be paid for at a lump sum or Unit Price agreed upon in writing by the Project Manager and Contractor before the extra Work Order is issued. In the negotiation of lump sum or Unit Prices, the agreed estimated cost of the Work plus an allowance for overhead and profit, not to exceed the allowances stated in Section 11.5.3, shall be used.
- 11.5.3 The allowance for overhead and profit will include full compensation for superintendence, bonds and insurance premiums, taxes (other than sales or use taxes included in the cost of materials), office expense, and all other items of expense or cost not included in the cost of labor, materials, or equipment provided under Sections 11.5.4, 11.5.5 and 11.5.6. The allowance for overhead and profit will be according to the following schedule:

ACTUAL NECESSARY COST ALLOWANCE:

Labor	20 percent
Materials	15 percent
Equipment	10 percent

The Actual Necessary Cost for labor, materials, or equipment will be computed according to Sections 11.5.4, 11.5.5 and 11.5.6.

Superintendence, bond and insurance premiums, taxes (other than sales or use taxes inclusive in the cost of materials), and other general expense will not be included in the computation of actual necessary cost. When all or any part of the extra Work is performed by a Subcontractor or specialty firm, the prime Contractor may add five percent of the Subcontractor's total cost for the extra Work. The Contractor shall give the Project Manager daily report sheets covering the direct cost of labor and materials and charges for equipment. The daily report sheets shall provide names or identifications and classifications of workers and hours worked, as well as size, type and identification number of equipment and hours operated. Material charges shall be substantiated by valid copies of vendors' invoices. The Project Manager will make any necessary adjustments and compile the costs of cost-plus Work. When these reports are agreed upon and signed by both parties, they become the basis of payment for the Work performed.

- 11.5.4 Labor: The cost of labor used in performing the Work by the Contractor, a Subcontractor, or other forces will be the sum of the actual wages paid plus any employer payments to, or on behalf of, workers for fringe benefits including health and welfare, pension, vacation, and similar purposes; all payments imposed by State and Federal laws including, but not limited to, compensation insurance, and social security payments; and the amount paid for subsistence and travel required in accordance with the regular practice of the employer.

At the beginning of the contract or as later requested by the Project Manager, the Contractor shall furnish the Project Manager proof of labor compensation rates being paid or already paid.

- 11.5.5 Materials: The cost of materials used in performing the Work, including transportation charges for delivery (exclusive of machinery rentals), will be the cost to the purchaser, whether Contractor, Subcontractor or other forces, from the Supplier thereof, inclusive of sales or use taxes, except if, in the opinion of the Project Manager, the cost of materials is excessive, or the Contractor does not furnish satisfactory evidence of the cost of such material. If the Project Manager finds the cost excessive or the Contractor has not furnished evidence of the cost, then the cost will be deemed to be the lowest current



wholesale price for the quantity concerned delivered to the job-site less cash or trade discounts.

The Town reserves the right to furnish materials for the Work and the Contractor may not claim costs and profit on materials furnished by the Town.

The Town reserves the right to purchase from the Contractor any materials previously purchased for a project and not used. Payment for the materials will be based on the actual material cost as shown on the Supplier's invoice, any transportation charges incurred, plus a fifteen percent handling fee.

- 11.5.6 Equipment: The Contractor will be paid according to the rental rates agreed upon in writing before extra or force account Work is begun, for any machinery or special equipment (other than small tools) authorized by the Project Manager. The Contractor may furnish cost data to assist the Project Manager in the establishment of the rental rate.

The rental rates paid, as provided above, shall include the cost of fuel, oil, lubrication supplies, small tools, necessary attachments, repairs and maintenance of all kinds, depreciation, storage, insurance, and all incidentals. Operator wages will be paid separately, as provided in Section 11.5.4.

Individual pieces of equipment or tools having a replacement value of \$100.00 or less, whether or not consumed by use, are considered small tools and no payment will be made for them.

Rental time will not be allowed while equipment is inoperative due to breakdowns or storage on-site.

- 11.5.7 Equipment on the Work: The rental time to be paid for equipment on the Work is the time the equipment is in productive operation on the extra Work being performed.
- 11.5.8 Eliminating Items: The Project Manager shall notify the Contractor in writing to eliminate any items contained in the proposal unnecessary for the proper completion of the Work. Such action will not invalidate the contract. The Contractor, by Change Order, will be reimbursed for actual work done and all cost incurred, including mobilization of materials and equipment before the elimination of such items.

Article 12--CONTRACT TIME

12.1 General

- 12.1.1 Time is of the essence in the performance of all Work contemplated in the Contract. Therefore, the Work shall be commenced no later than ten days from and including the date of Notice to Proceed and shall be fully completed in a satisfactory and acceptable manner within the time stated in the Contract.
- 12.1.2 The capacity of the Contractor's construction plant and force shall be sufficient as to insure completion of the Project within the allotted time. The Contractor shall use multiple crews if necessary to complete the Project within the allotted time.

12.2 Delays



12.2.1 Delay claims fall into three categories: non-excusable, excusable, or compensable. Any payment for delays or the granting of time extensions require a properly executed Change Order per Article 11.

12.2.2 **Non-excusable delay** is one caused by factors within the Contractor's reasonable control. The delay is the Contractor's fault; no additional time or additional compensation is allowed. Typical types of non-excusable delays are:

- X Late submittal of Shop Drawings;
- X Late procurement of materials or equipment;
- X Insufficient personnel;
- X Unqualified personnel;
- X Inadequate coordination of Subcontractors or other contractors;
- X Subcontractor delays;
- X Late response to Town and Project Manager inquiries; or
- X Construction not conforming to contract requirements making repeated re-working necessary.

12.2.3 **Excusable delay** is caused by factors beyond the Contractor's reasonable control, but is not the result of the Town's actions or failure to act. An excusable delay entitles the Contractor to an extension of time but no additional compensation for the cost of the delay.

12.2.4 **Compensable delay** is one where the Town has failed to meet an obligation stated or implied in the construction contract. If the Project Manager considers a delay as compensable, the Town will grant a time extension and reimburse the Contractor for the increased cost caused by the delay. Typical types of Town-caused delays are:

- X Late approval of Shop Drawings and samples;
- X Delays in answers to field inquiries by the Contractor;
- X Interference with the Contractor during construction;
- X Town-caused schedule changes;
- X Design changes; or
- X Interference by other contractor's or the Town's forces.

12.2.5 Failure to Prosecute Work. If, in the opinion of the Town's Project Manager, or other authorized agent of the Town, the Contractor is not prosecuting the Work under the Contract, written notice will be given and the Contractor shall have seven days to resume the Work with due diligence.

12.3 Failure to Complete Work on Time--Liquidated Damages

12.3.1 The Town may permit the Contractor to proceed if the Contractor fails to complete the Work on or before the original date set forth for or on or before the corrected. In such case, the Town will deduct the sum specified in the Contract for each day that the Work remains uncompleted. This sum shall not be a penalty but is liquidated damages.

12.3.2 The parties agree that, under all of the circumstances, the daily basis and the amount set forth as liquidated damages is reasonable and equitable. The Town expends additional personnel effort in administrating the Contract or portions of it that are not completed on



time, and such efforts and the costs thereof are impossible to accurately compute. In addition, some, if not all, citizens of Castle Rock incur personal inconvenience and lose confidence in their government as a result of public projects or parts of them not being completed on time, and the impact and damages, certainly serious in monetary as well as other terms, are impossible to measure.

- 12.3.3 Permitting the Contractor to continue and finish the Work, or any part of it, after the time fixed for its completion, or after the date to which the time of completion may have been extended, shall not operate as a waiver on the part of the Town of liquidated damages or any of its rights under the Contract.

Article 13--WARRANTY AND GUARANTEE: SAMPLES AND TESTING; DEFECTIVE WORK AND MATERIALS

13.1 Warranty and Guarantees

13.1.1 The Contractor and its Surety are jointly responsible for maintenance and satisfactory operation of Work performed under the Contract for a period of one year following the Notice of Construction Completion or until warranty work is fully satisfied. They are responsible for the satisfactory repair or replacement of any Work, materials or equipment which are found defective during this period, provided any failure results directly or indirectly from faulty workmanship or negligence by the Contractor, from faulty manufacturing or from faulty erection or improper handling of materials or equipment furnished or installed by the Contractor. Neither the Contractor nor Surety are liable for any failure resulting from the Town's neglect or improper operation of facilities or the act of a third party.

13.1.2 The obligations of 13.1.1 shall survive termination of the Contract under the provisions of Article 15.

13.2 Samples and Testing

13.2.1 All materials and equipment used in the Project will be subject to sampling and testing according to generally accepted standards and as required in the Contract Documents. In the absence of direct references, the sampling and testing of materials will be done according to current Specifications of the American Society for Testing and Materials or the American Water Works Association. The Contractor shall cooperate with the Project Manager in collecting and forwarding required samples.

13.2.2 The Contractor shall not incorporate any materials into the Project or cover any part of the Work until it has been inspected and approved according to the Contract Documents.

13.2.3 The Contractor shall furnish all samples without charge. The Contractor will cooperate with the Project Manager in collecting, handling, storing, and forwarding required samples including the furnishing of manpower and equipment when necessary.

13.2.4 The Contractor will pay the cost of the initial test except when the Contract states otherwise. The Contractor will pay the costs for repeated tests due to failure of the initial test.

13.3 Access to Work



13.3.1 The Project Manager and the Manager's representatives shall have access to the Project at any time for purposes of inspection, sampling, and testing. Access shall extend to authorized representatives of participating federal or state agencies and to other public authorities having jurisdiction established by law. The Contractor shall provide proper facilities for access to the Project.

13.3.2 Access to the Project shall mean wherever and whenever it is in manufacture, preparation or progress. It shall include access to payrolls, records of personnel, invoices of materials, terms and conditions of sale of materials and equipment to be incorporated in the Project, files, records, books, correspondence, instructions, Drawings, receipts, subcontracts, purchase orders, vouchers, memoranda and any other relevant data and records relating to the Contract.

13.3.3 The Town may, at reasonable times, inspect the part of the plant, place of business or worksite of the Contractor or Subcontractor at any tier which is pertinent to the performance of the Contract.

13.4 **Defective Work and Materials**

13.4.1 Material and workmanship not conforming to the requirements of the Contract are deemed defective. Defective Work or material shall be removed immediately from the Project site and replaced with acceptable Work and material at the Contractor's expense.

13.4.2 If the Contractor fails to replace rejected materials or Work within ten days after receipt of written notice, the Town may replace or correct them and charge the cost to the Contractor and may terminate the right of the Contractor to proceed. Failure to detect previously installed defective materials or workmanship shall not impair the Town's right to receive a completed project which is free of defects and meets all of the requirements of the Contract Documents.

Article 14--PAYMENTS TO CONTRACTOR AND COMPLETION

14.1 **General**

14.1.1 Unless expressly provided otherwise, the prices shown in the Bid Schedule include the cost of all labor, materials, equipment, tools, forms, services, utilities, royalties, fees, and any other thing or expense necessary to complete the Project. Items not shown on the Plans, Specifications or Special Provisions but which are necessary to construct the Project will be considered a part of the Project whether specified or not and no separate payment will be made for these items.

14.1.2 Unless expressly provided otherwise in the Contract, the amount to be paid for the Work includes all labor, materials, forms, tools, scaffolding, plants, equipment, service, utilities, royalties, fees, and everything, whether temporary or permanent, necessary to complete the Project.

14.2 **Determination of Amounts and Quantities:** The Project Manager shall verify determinations of amounts and quantities of Work performed. The Project Manager shall have access to the records as stated in Article 13.3. The method of measurement of the Contract Bid Items will be as specified in the Special Conditions.



14.3 Variations in Estimated Quantities

- 14.3.1 Where the quantity of a pay item in the Contract is an estimated quantity and where the actual quantity of such pay item varies more than twenty-five percent below the estimated quantity stated in the Contract, the Contractor shall make an equitable adjustment in the Contract Price, upon demand of the Town. The Contract Price adjustment will be based upon any decrease in costs due solely to the variation below seventy-five percent of the estimated quantity.
- 14.3.2 Where the quantity of a pay item in the Contract is an estimated quantity and the actual quantity of such pay item is more than twenty-five percent above the estimated quantity in the Contract, the Town may elect to terminate the Contract or issue a Change Order to adjust the Contract Price.

14.4 Monthly Estimates--Partial Payments

- 14.4.1 The Contractor shall prepare monthly partial estimates (monthly estimates) for all Work completed up to that time. The authorized Town representative(s) shall approve the monthly estimates before progress payments will be made. The format of the monthly estimates will be related to the format of the Bid Proposal.
- 14.4.2 14.0.7 In making such progress payments, subject to the exceptions in this Article, the Town will retain five percent of the total amount earned as indicated in the monthly estimate until the Project is substantially completed, provided, however, that at any time after the value of the completed Work equals or exceeds fifty percent of the face value of the Contract, the Town shall, if it finds that satisfactory progress is being made, retain the amount previously withheld but make the remaining partial payments in full. At no time may the amount retained exceed five percent of the total Contract Price.
- 14.4.3 Intentionally deleted.
- 14.4.4 If the Town finds that satisfactory progress is being made in all phases of the Contract, it may, upon written request by the Contractor, authorize payment from the withheld percentage. Before such payment is made, the Town shall determine that satisfactory and substantial reasons exist for the payment and shall require written approval from any Surety furnishing Bonds for the Contract. The Contractor shall make partial payments of the amount due to each of its Subcontractors in the same manner as the Town is required to pay the Contractor under this Article, providing that the Subcontractor is satisfactorily performing under its Contract with the Contractor.
- 14.4.5 Monthly estimates may include the value of acceptable materials required in the construction which have been delivered on the site of the Work or to adjacent railway siding and for which acceptable provisions have been made for preservation and storage, providing the Contractor submits with its monthly estimate, paid invoices in duplicate for the material for which payment is being requested. Material paid for by the Town becomes the property of the Town and, in the event of the default on the part of the Contractor, the Town may use or cause to be used such materials in construction of the Work provided for in the Contract.



14.4.6 The Town may withhold, in addition to retained percentages from Contractor payments, such an amount or amounts as may be necessary to cover:

14.4.6.1 Claims for labor or materials furnished the Contractor or Subcontractor(s) or reasonable evidence indicating probable filing of such claims;

14.4.6.2 Failure of the Contractor to make proper payment to Subcontractors or for material or labor furnished by others;

14.4.6.3 A reasonable doubt that the Contract can be completed for the balance then unpaid;

- * Evidence of damage to another Contractor or private property;
- * Uncorrected defective Work or guarantees that have not been met;
- * Failure of the Contractor to submit cost breakdowns, schedules, reports and other information required under the Contract;
- * Persistent failure to carry out the Work according to the Contract; or
- * Reasonable evidence that the Work will not be completed within the Contract Time, and that the unpaid balance would not be adequate to cover actual or liquidated damages for the anticipated delay.

14.4.7 The Town may disburse and has the right to act as agent for the Contractor in disbursing funds, withheld pursuant to this paragraph, to the party or parties who are entitled to payment therefrom, but the Town assumes no obligation to make such disbursement. The Town will render to the Contractor a proper accounting of all funds disbursed under this paragraph.

14.5 **Escrow Contract in Lieu of Retainage**

14.5.1 When sums are withheld to assure satisfactory performance of any contract exceeding fifty thousand dollars, the Contractor may withdraw the whole or any portion of the withheld sums if the Contractor deposits acceptable securities with the Director of Finance to negotiate the acceptable securities and to receive the payments due the Town pursuant to law or the terms of the Contract. To the extent there are excess funds resulting from negotiation, the balance shall be returned to the Contractor. Acceptable securities which are deposited shall have a market value at least equal in value to the amount withdrawn at all times. If at any time the Town determines that the market value of the acceptable securities deposited has fallen below the amount withdrawn, the Director of Finance shall give notice to the Contractor, who shall deposit additional acceptable securities in an amount sufficient to re-establish a total deposit of securities equal in value to the amount withdrawn.

14.5.2 The Town may enter into an escrow contract or agreement with any national bank, state bank, trust company or savings and loan association located in this state and designated by the Contractor, after notice to the Surety, to provide an escrow agent for the custodial care and servicing of any obligations deposited with it pursuant to §24-91-106, C.R.S., as amended. Such services shall include the safekeeping of the obligations and the rendering of all services required to effectuate the purpose of §24-91-106 and §38-26-107, C.R.S., as amended.



- 14.5.3 The Town or any national bank, state bank, trust company or savings and loan association located in the state and designated by the Contractor to serve as custodian for the obligations pursuant to §24-91-106, C.R.S., as amended, shall collect all interest and income when due on the obligations deposited and shall pay them, when and as collected, to the Contractor who deposited the obligations. If the deposit is in the form of coupon Bonds the escrow agent shall deliver each coupon, as it matures, to the Contractor. The Contractor may not charge any expense incurred for this service to the Town.
- 14.5.4 Any amount deducted by the Town, pursuant to law or the terms of a Contract, from the retained payments otherwise due to the Contractor, will be deducted first from that portion of the retained payments for which no obligation has been substituted and then from the proceeds of any deposited obligation, in which case, the Contractor is entitled to receive the interest, coupons or income only from those obligations which remain on deposit after such amount has been deducted.
- 14.5.5 Provided that the Subcontractor has performed under its Contract with the Contractor, the Contractor shall disburse to each Subcontractor all retained payments and interest disbursed to the Contractor by the Town, in proportion to the respective amounts of retained payments, if any, which the Contractor has withheld from its Subcontractors.
- 14.5.6 The provisions of this Article do not apply if a part of the Contract Price is to be paid with funds from the federal government or from some other source and if the federal government or such other source has inconsistent requirements concerning retention or payment of funds applicable to the Contract.
- 14.5.7 If it becomes necessary for the Town to take over the completion of any Contract, all of the amount owed the Contractor, including the withheld percentage, shall first be applied toward the cost of completion of the Contract and any liquidated damages. Any balance remaining in the retained percentage shall be payable to the Contractor or the Contractor's creditors. Such retained percentage, as may be due any Contractor, shall be due and payable at the expiration of thirty days from the date of the Town Project Final Acceptance.
- 14.6 **Town's Right to Accept Portion of the Project:** The Town reserves the right to accept and make use of any completed section of the Project without invalidating the Contract or obligating the Town to accept the remainder of the Project.
- 14.7 **Substantial Completion:** When the Contractor considers the entire work ready for its intended use, the Contractor shall notify the Project Manager in writing that the entire Work is substantially complete (except for items specifically listed by Contractor as incomplete) and request that the Project Manager issue a Notice of Substantial Completion. Within a reasonable time, the Contractor, Project Manager and any other appropriate Town representatives shall make an inspection of the Work to determine the status of completion. If the Project Manager does not consider the Work substantially complete, the Project Manager will notify the Contractor in writing giving the reasons for denial of the Notice of Substantial Completion. If the Project Manager considers the Work substantially complete, the Project Manager will prepare and deliver to the contractor a Notice of Substantial Completion which shall fix the date of Substantial Completion. The Project Manager shall attach to the certificate a tentative list ("punch list") of items to be completed or corrected before Final Payment. Warranties required by the Contract shall commence on the date set in the Notice of Construction Completion for the Project, or the date set in the Notice of Construction Completion for a designated portion of the Project, unless otherwise provided in the notice of Substantial Completion.



- 14.8 **Construction Completion:** When the Work specified in the Contract is completed and the final cleanup has been performed, the Contractor shall notify the Project Manager that all Work under the Contract has been completed and the Project Manager shall, within five days after such notice, make the final inspection. If the Project Manager finds that the Project has been completed according to the requirements set forth in the Contract, the Town, upon the recommendation of the Project Manager, shall issue a Notice of Construction Completion. Notices of Construction Completion issued orally or without proper Town authorization are void.
- 14.9 **Claims Against the Contractor**
- 14.9.1 Intentionally deleted.
- 14.9.2 As provided by Colorado law, persons or businesses, including Subcontractors, who have not been promptly paid by the Contractor and who have provided materials, services and labor of any kind, or labor and material incidental to the completion of the Project, may file claims and the Town may withhold from the Contractor an amount sufficient to cover such claims.
- 14.10 **Final Payment--Pursuant to Section 38-26-107, C.R.S., as Amended**
- 14.10.1 After the Notice of Construction Completion is issued by the Town, a Notice of Final Settlement shall be advertised at least twice, not less than ten days before the date of Final Settlement, in a newspaper of general circulation in the county where the Work was done. If no claims are filed before the expiration of ten days from the date of the last publication of the Notice of Final Settlement, the Final Payment, including retainage, may be made.
- 14.10.2 If any Subcontractor or Supplier files a claim before the expiration of ten days from the date of the last publication of the Notice of Final Settlement, for Work done or material furnished that has not been paid for by the Contractor, the Town shall withhold from Final Payment to the Contractor sufficient funds to insure the payment of the claims. The funds shall not be withheld longer than ninety days from the date of Final Settlement unless a legal action is started within that time to enforce payment of the claims.
- 14.10.3 At the end of ninety days, or any time before, if the person filing the claim acknowledges receipt of payment for the claim, or otherwise releases the claim in writing, the Town shall pay the Contractor the monies not subject to suit or lis pendens notices.
- 14.10.4 Monies that are the subject of a suit will be withheld until a judgment is rendered in the suit.

Article 15--CONTRACT TERMINATION

- 15.1 **Town's Right to Terminate Contract for Convenience:** The Town shall, at any time, have the right to terminate the Contract, for convenience, upon giving written notice to the Contractor. The Contractor shall be entitled to the full amount of the approved estimate for the Work satisfactorily completed under the Contract up to the time of such termination, including the retained percentage. The Town shall reimburse the Contractor for such expenditures as, in the judgment of the Project Manager, are not otherwise compensated for, together with the cost of moving to and from the Project and a reasonable profit on the Work deleted by reason of the annulment of the Contract, in order that an equitable settlement is made with the Contractor.



15.2 **Town's Right to Terminate Contract for Default:** Project Manager, with the approval of the Town and acting on behalf of the Town, may serve notice upon the Contractor and its Surety of the intention to terminate the Contract if the performance of the Work set forth under the Contract is unnecessarily or unreasonably delayed by the Contractor, or if any of the provisions of the Contract are being violated by the Contractor or its Subcontractors. The Contract is terminated unless, in the opinion of the Project Manager, the Contractor corrects the violation within five days after the notice is served. In the event of such termination, the Project Manager, acting on behalf of the Town, shall immediately serve notice of the termination and the Surety's right to complete the Contract upon the Surety and the Contractor. The Surety shall have the right to take over and perform the Work called for in the Contract. The Surety is then bound by all the provisions of the Contract. If the Surety does not commence performance of the Work within ten days from the date of the notice, the Town may take over the Project and, without prejudice to any other remedies, complete the Project and the Contractor and its Surety are liable to the Town for any excess costs incurred by the Town.

15.3 **Contractor's Right to Terminate Contract**

15.3.1 The Contractor may terminate the Contract if the Work is stopped for a period of three months under any order of any court or other public authority through no act or fault of the Contractor or of anyone employed by it.

15.3.2 The Contractor may suspend Work if Town fails to make payments at the times provided in the Contract and the Contractor has given the Town written notice seven days before suspending Work. The Contractor may terminate the Contract, at its option, if the Town continues to be in default thirty days after the date of the written notice. Failure by the Town to make payments at the times provided is a bar to any claim by the Town against the Contractor for delay in completion of the Project if the Contractor suspended Work for that reason.

15.3.3 If the Contractor terminates the Contract, it may recover the price of all Work done and materials provided and all damages sustained.

Article 16--EQUAL OPPORTUNITY

16.1 **General:** During the performance of the Contract, the Contractor agrees as follows:

16.1.1 The Contractor shall not discriminate against any employee or applicant for employment because of race, color, age, disability, religion, sex, national origin, or as otherwise prohibited by law.

16.1.2 The Contractor shall ensure that all Subcontractors shall not discriminate against any employee or applicant for employment because of race, color, age, disability, religion, sex, national origin, or as otherwise prohibited by law.

Article 17--AUDIT

17.1 **Records and Reports**

17.1.1 The Contractor shall keep and preserve full and detailed accounts relating to the Contract for a period of three years from the date of final payment under the Contract in which the Work is completed.



17.1.2 The Subcontractor shall keep and preserve full and detailed accounts relating to the Contract for a period of three years from the date of final payment under the subcontract.

17.2 Access

17.2.1 The Contractor shall permit the Town and the Town's accountants to have access as stated in Article 13.3 and to the records kept per Article 17.2 for the purpose of making such financial audits, or verifications as the Town deems necessary or appropriate concerning the Contractor's performance under the Contract.

Article 18--MISCELLANEOUS

- 18.1 **Reservation of Right to Bar Persons from the Work and Site:** The Town reserves the right to bar any person, including employees of the Contractor and Subcontractors, from the Town's Work site. This shall not be treated as a request for the employee's termination but a request that the employee not be assigned to work on the Town Work site. No increase in contract time or price is authorized.
- 18.2 **Provisions Construed as to Fair Meaning.** The provisions of the Contract shall be construed as to their fair meaning, and not for or against any party based upon any attributes to such party of the source of the language in question.
- 18.3 **Headings for Convenience:** All headings, captions and titles are for convenience and reference only and of no meaning in the interpretation or effect of the Contract.
- 18.4 18.1 **No Implied Representations:** No representations, agreements, covenants, warranties, or certifications, express or implied, exist as between the parties, except as specifically set forth in the Contract.
- 18.5 **Financial Obligations of Town:** All financial obligations of the Town under the Contract are contingent upon appropriation, budgeting, and availability of specific funds to discharge such obligations. Nothing in the Contract shall be deemed a pledge of the Town's credit, or a payment guarantee by the Town to the Contractor.
- 18.6 **Assignment/transference:** The Contractor may not assign or transfer any interest in the Contract, including any money due or to become due, without the prior written consent of the Town.
- 18.7 **Amendments.** The parties shall only amend the Contract in writing with the proper official signatures and, if required elsewhere in this Contract, on the proper forms.
- 18.8 **Waiver.** No waiver of a breach or default under the Contract is a waiver of any other or subsequent breach or default.
- 18.9 **Governing Law.** The Contract is governed and to be construed according to the laws of the State of Colorado.
- 18.10 **Binding Contract.** The Contract is binding upon the parties hereto and their respective heirs, executors, administrators, successors and assigns.

Article 19--Davis-Bacon and Related Act Provisions



19.1 **Applicability.** This section is applicable to each contract in excess of \$2,000 which is entered into for the actual construction, alteration and/or repair, including painting and decorating, of a public building or public work, or building or work financed in whole or in part from Federal funds or in accordance with guarantees of a Federal agency or financed from funds obtained by pledge of any contract of a Federal agency to make a loan, grant or annual contribution (except where a different meaning is expressly indicated), and which is subject to the labor standards provisions of any of the acts listed in § 5.1 of 29 C.F.R.

19.2 **Minimum Wages.**

(i) All laborers and mechanics employed or working upon the site of the work (or under the United States Housing Act of 1937 or under the Housing Act of 1949 in the construction or development of the project), will be paid unconditionally and not less often than once a week, and without subsequent deduction or rebate on any account (except such payroll deductions as are permitted by regulations issued by the Secretary of Labor under the Copeland Act (29 CFR part 3)), the full amount of wages and bona fide fringe benefits (or cash equivalents thereof) due at time of payment computed at rates not less than those contained in the wage determination of the Secretary of Labor which is attached hereto and made a part hereof, regardless of any contractual relationship which may be alleged to exist between the contractor and such laborers and mechanics. Contributions made or costs reasonably anticipated for bona fide fringe benefits under section 1(b)(2) of the Davis–Bacon Act on behalf of laborers or mechanics are considered wages paid to such laborers or mechanics, subject to the provisions of paragraph (a)(1)(iv) of this section; also, regular contributions made or costs incurred for more than a weekly period (but not less often than quarterly) under plans, funds, or programs which cover the particular weekly period, are deemed to be constructively made or incurred during such weekly period. Such laborers and mechanics shall be paid the appropriate wage rate and fringe benefits on the wage determination for the classification of work actually performed, without regard to skill, except as provided in § 5.5(a)(4) of 29 C.F.R. Laborers or mechanics performing work in more than one classification may be compensated at the rate specified for each classification for the time actually worked therein: Provided, That the employer's payroll records accurately set forth the time spent in each classification in which work is performed. The wage determination (including any additional classification and wage rates conformed under paragraph (a)(1)(ii) of this section) and the Davis–Bacon poster (WH–1321) shall be posted at all times by the contractor and its subcontractors at the site of the work in a prominent and accessible place where it can be easily seen by the workers.

(ii) (A) The contracting officer shall require that any class of laborers or mechanics, including helpers, which is not listed in the wage determination and which is to be employed under the contract shall be classified in conformance with the wage determination. The contracting officer shall approve an additional classification and wage rate and fringe benefits therefore only when the following criteria have been met:

- (1) The work to be performed by the classification requested is not performed by a classification in the wage determination; and
- (2) The classification is utilized in the area by the construction industry; and
- (3) The proposed wage rate, including any bona fide fringe benefits, bears a reasonable relationship to the wage rates contained in the wage determination.

(B) If the contractor and the laborers and mechanics to be employed in the classification (if known), or their representatives, and the contracting officer agree on the classification



and wage rate (including the amount designated for fringe benefits where appropriate), a report of the action taken shall be sent by the contracting officer to the Administrator of the Wage and Hour Division, U.S. Department of Labor, Washington, DC 20210. The Administrator, or an authorized representative, will approve, modify, or disapprove every additional classification action within 30 days of receipt and so advise the contracting officer or will notify the contracting officer within the 30-day period that additional time is necessary.

(C) In the event the contractor, the laborers or mechanics to be employed in the classification or their representatives, and the contracting officer do not agree on the proposed classification and wage rate (including the amount designated for fringe benefits, where appropriate), the contracting officer shall refer the questions, including the views of all interested parties and the recommendation of the contracting officer, to the Administrator for determination. The Administrator, or an authorized representative, will issue a determination within 30 days of receipt and so advise the contracting officer or will notify the contracting officer within the 30-day period that additional time is necessary.

(D) The wage rate (including fringe benefits where appropriate) determined pursuant to paragraphs (a)(1)(ii)(B) or (C) of this section, shall be paid to all workers performing work in the classification under this contract from the first day on which work is performed in the classification.

- (iii) Whenever the minimum wage rate prescribed in the contract for a class of laborers or mechanics includes a fringe benefit which is not expressed as an hourly rate, the contractor shall either pay the benefit as stated in the wage determination or shall pay another bona fide fringe benefit or an hourly cash equivalent thereof.
- (iv) If the contractor does not make payments to a trustee or other third person, the contractor may consider as part of the wages of any laborer or mechanic the amount of any costs reasonably anticipated in providing bona fide fringe benefits under a plan or program, Provided, That the Secretary of Labor has found, upon the written request of the contractor, that the applicable standards of the Davis-Bacon Act have been met. The Secretary of Labor may require the contractor to set aside in a separate account, assets for the meeting of obligations under the plan or program.

19.3 **Withholding.** The contracting agency shall upon its own action or upon written request of an authorized representative of the Department of Labor withhold or cause to be withheld from the contractor under this contract or any other Federal contract with the same prime contractor, or any other federally-assisted contract subject to Davis-Bacon prevailing wage requirements, which is held by the same prime contractor, so much of the accrued payments or advances as may be considered necessary to pay laborers and mechanics, including apprentices, trainees, and helpers, employed by the contractor or any subcontractor the full amount of wages required by the contract. In the event of failure to pay any laborer or mechanic, including any apprentice, trainee, or helper, employed or working on the site of the work (or under the United States Housing Act of 1937 or under the Housing Act of 1949 in the construction or development of the project), all or part of the wages required by the contract, the contracting agency may, after written notice to the contractor, sponsor, applicant, or owner, take such action as may be necessary to cause the suspension of any further payment, advance, or guarantee of funds until such violations have ceased.

19.4 **Payrolls and basic records.**



- (i) Payrolls and basic records relating thereto shall be maintained by the contractor during the course of the work and preserved for a period of three years thereafter for all laborers and mechanics working at the site of the work (or under the United States Housing Act of 1937, or under the Housing Act of 1949, in the construction or development of the project). Such records shall contain the name, address, and social security number of each such worker, his or her correct classification, hourly rates of wages paid (including rates of contributions or costs anticipated for bona fide fringe benefits or cash equivalents thereof of the types described in section 1(b)(2)(B) of the Davis–Bacon Act), daily and weekly number of hours worked, deductions made and actual wages paid. Whenever the Secretary of Labor has found under 29 CFR 5.5(a)(1)(iv) that the wages of any laborer or mechanic include the amount of any costs reasonably anticipated in providing benefits under a plan or program described in section 1(b)(2)(B) of the Davis–Bacon Act, the contractor shall maintain records which show that the commitment to provide such benefits is enforceable, that the plan or program is financially responsible, and that the plan or program has been communicated in writing to the laborers or mechanics affected, and records which show the costs anticipated or the actual cost incurred in providing such benefits. Contractors employing apprentices or trainees under approved programs shall maintain written evidence of the registration of apprenticeship programs and certification of trainee programs, the registration of the apprentices and trainees, and the ratios and wage rates prescribed in the applicable programs.
- (ii) (A) The contractor shall submit weekly for each week in which any contract work is performed a copy of all payrolls to the (write in name of appropriate federal agency) if the agency is a party to the contract, but if the agency is not such a party, the contractor will submit the payrolls to the applicant, sponsor, or owner, as the case may be, for transmission to the (write in name of agency). The payrolls submitted shall set out accurately and completely all of the information required to be maintained under 29 CFR 5.5(a)(3)(i), except that full social security numbers and home addresses shall not be included on weekly transmittals. Instead the payrolls shall only need to include an individually identifying number for each employee (e.g., the last four digits of the employee's social security number). The required weekly payroll information may be submitted in any form desired. Optional Form WH–347 is available for this purpose from the Wage and Hour Division Web site at <http://www.dol.gov/esa/whd/forms/wh347instr.htm> or its successor site. The prime contractor is responsible for the submission of copies of payrolls by all subcontractors. Contractors and subcontractors shall maintain the full social security number and current address of each covered worker, and shall provide them upon request to the (write in name of appropriate federal agency) if the agency is a party to the contract, but if the agency is not such a party, the contractor will submit them to the applicant, sponsor, or owner, as the case may be, for transmission to the (write in name of agency), the contractor, or the Wage and Hour Division of the Department of Labor for purposes of an investigation or audit of compliance with prevailing wage requirements. It is not a violation of this section for a prime contractor to require a subcontractor to provide addresses and social security numbers to the prime contractor for its own records, without weekly submission to the sponsoring government agency (or the applicant, sponsor, or owner).
- (B) Each payroll submitted shall be accompanied by a “Statement of Compliance,” signed by the contractor or subcontractor or his or her agent who pays or supervises the payment of the persons employed under the contract and shall certify the following:



- (1) That the payroll for the payroll period contains the information required to be provided under § 5.5 (a)(3)(ii) of Regulations, 29 CFR part 5, the appropriate information is being maintained under § 5.5 (a)(3)(i) of Regulations, 29 CFR part 5, and that such information is correct and complete;
- (2) That each laborer or mechanic (including each helper, apprentice, and trainee) employed on the contract during the payroll period has been paid the full weekly wages earned, without rebate, either directly or indirectly, and that no deductions have been made either directly or indirectly from the full wages earned, other than permissible deductions as set forth in Regulations, 29 CFR part 3;
- (3) That each laborer or mechanic has been paid not less than the applicable wage rates and fringe benefits or cash equivalents for the classification of work performed, as specified in the applicable wage determination incorporated into the contract.

(C) The weekly submission of a properly executed certification set forth on the reverse side of Optional Form WH-347 shall satisfy the requirement for submission of the "Statement of Compliance" required by paragraph (a)(3)(ii)(B) of this section.

(D) The falsification of any of the above certifications may subject the contractor or subcontractor to civil or criminal prosecution under section 1001 of title 18 and section 231 of title 31 of the United States Code.

- (iii) The contractor or subcontractor shall make the records required under paragraph (a)(3)(i) of this section available for inspection, copying, or transcription by authorized representatives of the (write the name of the agency) or the Department of Labor, and shall permit such representatives to interview employees during working hours on the job. If the contractor or subcontractor fails to submit the required records or to make them available, the Federal agency may, after written notice to the contractor, sponsor, applicant, or owner, take such action as may be necessary to cause the suspension of any further payment, advance, or guarantee of funds. Furthermore, failure to submit the required records upon request or to make such records available may be grounds for debarment action pursuant to 29 CFR 5.12.

19.5 **Apprentices and trainees.**

- (i) Apprentices. Apprentices will be permitted to work at less than the predetermined rate for the work they performed when they are employed pursuant to and individually registered in a bona fide apprenticeship program registered with the U.S. Department of Labor, Employment and Training Administration, Office of Apprenticeship Training, Employer and Labor Services, or with a State Apprenticeship Agency recognized by the Office, or if a person is employed in his or her first 90 days of probationary employment as an apprentice in such an apprenticeship program, who is not individually registered in the program, but who has been certified by the Office of Apprenticeship Training, Employer and Labor Services or a State Apprenticeship Agency (where appropriate) to be eligible for probationary employment as an apprentice. The allowable ratio of apprentices to journeymen on the job site in any craft classification shall not be greater than the ratio permitted to the contractor as to the entire work force under the registered program. Any worker listed on a payroll at an apprentice wage rate, who is not registered or otherwise employed as stated above, shall be paid not less than the applicable wage rate on the wage determination for the classification of work actually performed. In addition, any apprentice performing work on the job site in excess of the ratio permitted under the registered program shall be paid not less than the applicable wage rate on the wage



determination for the work actually performed. Where a contractor is performing construction on a project in a locality other than that in which its program is registered, the ratios and wage rates (expressed in percentages of the journeyman's hourly rate) specified in the contractor's or subcontractor's registered program shall be observed. Every apprentice must be paid at not less than the rate specified in the registered program for the apprentice's level of progress, expressed as a percentage of the journeymen hourly rate specified in the applicable wage determination. Apprentices shall be paid fringe benefits in accordance with the provisions of the apprenticeship program. If the apprenticeship program does not specify fringe benefits, apprentices must be paid the full amount of fringe benefits listed on the wage determination for the applicable classification. If the Administrator determines that a different practice prevails for the applicable apprentice classification, fringes shall be paid in accordance with that determination. In the event the Office of Apprenticeship Training, Employer and Labor Services, or a State Apprenticeship Agency recognized by the Office, withdraws approval of an apprenticeship program, the contractor will no longer be permitted to utilize apprentices at less than the applicable predetermined rate for the work performed until an acceptable program is approved.

- (ii) **Trainees.** Except as provided in 29 CFR 5.16, trainees will not be permitted to work at less than the predetermined rate for the work performed unless they are employed pursuant to and individually registered in a program which has received prior approval, evidenced by formal certification by the U.S. Department of Labor, Employment and Training Administration. The ratio of trainees to journeymen on the job site shall not be greater than permitted under the plan approved by the Employment and Training Administration. Every trainee must be paid at not less than the rate specified in the approved program for the trainee's level of progress, expressed as a percentage of the journeyman hourly rate specified in the applicable wage determination. Trainees shall be paid fringe benefits in accordance with the provisions of the trainee program. If the trainee program does not mention fringe benefits, trainees shall be paid the full amount of fringe benefits listed on the wage determination unless the Administrator of the Wage and Hour Division determines that there is an apprenticeship program associated with the corresponding journeyman wage rate on the wage determination which provides for less than full fringe benefits for apprentices. Any employee listed on the payroll at a trainee rate who is not registered and participating in a training plan approved by the Employment and Training Administration shall be paid not less than the applicable wage rate on the wage determination for the classification of work actually performed. In addition, any trainee performing work on the job site in excess of the ratio permitted under the registered program shall be paid not less than the applicable wage rate on the wage determination for the work actually performed. In the event the Employment and Training Administration withdraws approval of a training program, the contractor will no longer be permitted to utilize trainees at less than the applicable predetermined rate for the work performed until an acceptable program is approved.
- (iii) **Equal employment opportunity.** The utilization of apprentices, trainees and journeymen under this part shall be in conformity with the equal employment opportunity requirements of Executive Order 11246, as amended, and 29 CFR part 30.

19.6 **Equal employment opportunity.** The utilization of apprentices, trainees and journeymen under this part shall be in conformity with the equal employment opportunity requirements of Executive Order 11246, as amended, and 29 CFR part 30.

19.7 **Subcontracts.** The contractor or subcontractor shall insert in any subcontracts the clauses contained in 29 CFR 5.5(a)(1) through (10) and such other clauses as the (write in the name of the Federal agency) may by appropriate instructions require, and also a clause requiring the



subcontractors to include these clauses in any lower tier subcontracts. The prime contractor shall be responsible for the compliance by any subcontractor or lower tier subcontractor with all the contract clauses in 29 CFR 5.5.

- 19.8 **Compliance with Davis–Bacon and Related Act requirements.** All rulings and interpretations of the Davis–Bacon and Related Acts contained in 29 CFR parts 1, 3, and 5 are herein incorporated by reference in this contract.
- 19.9 **Disputes concerning labor standards.** Disputes arising out of the labor standards provisions of this contract shall not be subject to the general disputes clause of this contract. Such disputes shall be resolved in accordance with the procedures of the Department of Labor set forth in 29 CFR parts 5, 6, and 7. Disputes within the meaning of this clause include disputes between the contractor (or any of its subcontractors) and the contracting agency, the U.S. Department of Labor, or the employees or their representatives.
- 19.10 **Certificate of eligibility.** By entering into this contract, the contractor certifies that neither it (nor he or she) nor any person or firm who has an interest in the contractor's firm is a person or firm ineligible to be awarded Government contracts by virtue of section 3(a) of the Davis–Bacon Act or 29 CFR 5.12(a)(1). No part of this contract shall be subcontracted to any person or firm ineligible for award of a Government contract by virtue of section 3(a) of the Davis–Bacon Act or 29 CFR 5.12(a)(1). The penalty for making false statements is prescribed in the U.S. Criminal Code, 18 U.S.C. 1001.
- 19.11 **Contract termination; debarment.** A breach of the contract clauses in 29 CFR 5.5 may be grounds for termination of the contract and for debarment as a contractor and a subcontractor as provided in 29 CFR 5.12.
- 19.12 **Complaints, Proceedings, or Testimony by Employees.** No laborer or mechanic, to whom the wage, salary, or other labor standards provisions of this Contract are applicable, shall be discharged or in any other manner discriminated against by the contractor or any subcontractor because such employee has filed any complaint or instituted or caused to be instituted any proceeding or has testified or is about to testify in any proceeding under or relating to the labor standards applicable under this Contract to his employer.
- 19.13 **Other.** Contractor shall comply with all applicable HUD forms which can be found at <http://www.hudclips.org/cgi/index.cgi>. The Forms applicable to this contract may include HUD-254, HUD-4010, HUD-5370, HUD-5370-EZ, and HUD-5370-C.

Article 20—Contract Work Hours and Safety Standards Act

- 20.1 **Applicability.** The clauses in this Article apply to any Federal-aid construction contract in an amount in excess of \$100,000 and subject to the overtime provisions of the Contract Work Hours and Safety Standards Act. These clauses shall be inserted in addition to the clauses required by 29 CFR 5.5(a) or 29 CFR 4.6. As used in this paragraph, the terms laborers and mechanics include watchmen and guards.
- 20.2 **Overtime requirements.** No contractor or subcontractor contracting for any part of the contract work which may require or involve the employment of laborers or mechanics shall require or permit any such laborer or mechanic in any workweek in which he or she is employed on such work to work in excess of forty hours in such workweek unless such laborer or mechanic receives



compensation at a rate not less than one and one-half times the basic rate of pay for all hours worked in excess of forty hours in such workweek.

- 20.3 **Violation; liability for unpaid wages; liquidated damages.** In the event of any violation of the clause set forth in 20.2 of this Article the contractor and any subcontractor responsible therefor shall be liable for the unpaid wages. In addition, such contractor and subcontractor shall be liable to the United States (in the case of work done under contract for the District of Columbia or a territory, to such District or to such territory), for liquidated damages. Such liquidated damages shall be computed with respect to each individual laborer or mechanic, including watchmen and guards, employed in violation of the clause set forth in 20.2 of this Article, in the sum of \$29 for each calendar day on which such individual was required or permitted to work in excess of the standard workweek of forty hours without payment of the overtime wages required by the clause set forth in 20.2 of this Article.
- 20.4 **Withholding for unpaid wages and liquidated damages.** The contracting agency shall upon its own action or upon written request of an authorized representative of the Department of Labor withhold or cause to be withheld, from any moneys payable on account of work performed by the contractor or subcontractor under any such contract or any other Federal contract with the same prime contractor, or any other federally-assisted contract subject to the Contract Work Hours and Safety Standards Act, which is held by the same prime contractor, such sums as may be determined to be necessary to satisfy any liabilities of such contractor or subcontractor for unpaid wages and liquidated damages as provided in the clause set forth in paragraph (b)(2) of this section.
- 20.5 **Subcontracts.** The contractor or subcontractor shall insert in any subcontracts the clauses set forth in 20.1-20.5 of this Article and also a clause requiring the subcontractors to include these clauses in any lower tier subcontracts. The prime contractor shall be responsible for compliance by any subcontractor or lower tier subcontractor with the clauses set forth in paragraphs 20.1-20.5 of this Article.
- 20.6 **Other.** In addition to the clauses contained in Article 20, in any contract subject only to the Contract Work Hours and Safety Standards Act and not to any of the other statutes cited in § 5.1 of 29 C.R.F, the Agency Head shall cause or require the contracting officer to insert a clause requiring that the contractor or subcontractor shall maintain payrolls and basic payroll records during the course of the work and shall preserve them for a period of three years from the completion of the contract for all laborers and mechanics, including guards and watchmen, working on the contract. Such records shall contain the name and address of each such employee, social security number, correct classifications, hourly rates of wages paid, daily and weekly number of hours worked, deductions made, and actual wages paid. Further, the Agency Head shall cause or require the contracting officer to insert in any such contract a clause providing that the records to be maintained under this paragraph shall be made available by the contractor or subcontractor for inspection, copying, or transcription by authorized representatives of the contracting agency and the Department of Labor, and the contractor or subcontractor will permit such representatives to interview employees during working hours on the job.



EXHIBIT 2
CONTRACTOR'S BID

Applied Ingenuity, LLC.
14920 Harvest Rd.
Brighton, Co 80603
Ph. (303) 289-2280 Fax (303) 289-1026

Scope of Work and Proposal

Date: September 14, 2023

Project: Castle Rock 2023 Well Cleaning and Reequip Project

From: Scott Martin, Applied Ingenuity. LLC

Thank you for asking *Applied Ingenuity* to provide you with this proposal for cleaning your and re-equipping your wells per your request

Scope of Work: *Applied Ingenuity* proposes the following scope of well cleaning for this project.

- Acid Clean:

Cleaning Service.....Spot Required Gallons of Coty Acid-Descaler into the well bore Spread into screen sections
Surge and Brush for 3 hours
Return the following day and test PH and add acid if necessary to bring PH to 2. Surge for 3 hours.
Return to site and sand pump well for 2 hours.
Bailing.....Sand pump well to achieve approx. original total depth of well.

Additional Materials

Labor for sand pump and surging...2 Man \$240 / Hour
Additional Acid.....\$37.00 / Gallon

- Depending on timing, an additional mob and demob may be necessary

Project Schedule:

All Dates commence 2 weeks after “ Notice to Proceed”

Notes:

- 1) Based on the pre-video of the wells, the cleaning methodology may change. It has been our experience that this is the best method to utilize if there is bacteriological growth in the well. Should the well screens be plugged with deposition, it may be more cost effective to clean with sonar jet, brushing with chlorine, and or pressure jetting screens.
- 2) Centrilift Equipment NSF certified on larger wells, 4-6 week delivery.
- 3) Stainless steel pipe for Well 111 is 6 5/8" pipe with epoxy coated J55 Couplings.

ADDENDUM 1

BID PROPOSAL

PROJECT: 2023/2024 Denver Basin Rehabilitation and Pumping Equipment Replacement Project

1. In compliance with your Invitation to Bid, and subject to all conditions thereof, the undersigned:

Applied Ingenuity, LLC

a Corporation incorporated in the State of Colorado

-OR- _____, a partnership, / limited partnership, (select one), registered in the State of _____, whose general partner(s) is/are

-OR- a sole proprietor, whose trade name is Applied Ingenuity, LLC

in the Town of Brighton, State of Colorado, offers this Bid Proposal for the construction of all items listed at the prices shown on the following Bid Schedule. (The attached Bid Schedule lists the various divisions of construction contemplated in the Plans and Specifications, together with an estimate of the units of each. With these units as the basis, extend each item, using the cost inserted in the unit column. Any total cost found inconsistent with the unit cost when the Bids are examined will be deemed in error and corrected to agree with the unit cost. Alternate Bids are optional.)

2. The undersigned Bidder declares and stipulates that this Bid is made in good faith, without collusion or connection with any other person or persons bidding for the same Work, and that it is made subject to all the terms and conditions of the Invitation to Bids, Information and Instruction for Bidders, and Construction Contract General Conditions, the Agreement for a Construction Contract, the Technical Specifications, and the Plans pertaining to the Work to be done, all of which have examined by the undersigned.

3. Accompanying this Bid is a Bid Guarantee for 5% of the total Bid amount according to the Invitation to Bids and Information and Instructions to Bidders.

4. The undersigned Bidder agrees to execute the Agreement for a Construction Contract, a Performance Bond and a Labor and Material Payment Bond within ten days from the date when the written Notice of Award is delivered at the address given on this Bid Proposal. The Performance Bond and Labor and Material Payment Bond shall each be for the amount of the total of this Bid and shall be from the same surety. The name and address of the corporate surety through which the Bidder proposes to furnish the specified Bonds is as follows:

5. The submission of the Bid constitutes an agreement, and it shall not be withdrawn after the Bid Opening for a period of thirty days.

6. All the various phases of work enumerated in the Contract with individual jobs and overhead, whether specifically mentioned or not, are included by implication or appurtenance in the Contract. The Contractor shall perform all the various phases of work under one of the items listed in the Bid Schedule, irrespective of whether it is named in the Schedule.

7. Payment for the Work performed will be according to the Bid Schedule, subject to changes as provided in the Contract.

ADDENDUM 1

8. The undersigned Bidder hereby acknowledges receipt of addenda numbers 1 through 1.

RETURN BID TO: TOWN OF CASTLE ROCK
CASTLE ROCK WATER
175 Kellogg Court
Castle Rock, CO 80109

The undersigned, being familiar with the existing conditions on the project area affecting the cost of the Work and the Contract Documents, and having verified the quantities and the availability of materials and labor, hereby proposes to furnish all supervision, labor, materials, machinery, tools, appurtenances, equipment, supplies, and services, including utility and transportation service required to construct and complete the Project listed above, according to the Contract, within the time specified, and at the prices stated below. These prices are to cover all expenses incurred in performing the Work required under the Contract of which this Bid is a part.

(The approximate quantities of Work to be completed in-place under the Contract are identified in the Bid Schedule and are for the purpose of comparing Bids. These quantities have been estimated and the quantities used are for the general information of the Bidder, representing the major items of the Work to be done. Minor details are not listed but shall be part of the complete Contract.)

9. The undersigned agrees to hold firm the Bid for **90** days for the purpose of the Town reviewing the Bids and investigating the qualifications of the Bidders prior to award of Contract. Mutually agreed upon extensions of time may be made if necessary.

This proposal is submitted by:

CONTRACTOR: Applied Ingenuity, LLC BY: Fred Scott Martin Scott Martin

ADDRESS: 14920 Harvest Rd.
Brighton, Co. 80603

TITLE: President

Attest:

SECRETARY: _____
(if corporation)

DATE: 9/14/2023

ADDENDUM 1

BID SCHEDULE***Quote for Well CR-84 Well Rehabilitation and Pumping Equipment Replacement***

Please complete quote pricing for the following tasks:

	Task Description	Unit	Quantity	Unit Price	Total
1	Mobilization, traffic control plan and permitting (if required)	Lump Sum	1	2550	2550
2	Pull existing equipment	Lump Sum	1	6053	6053
3	Conduct color well video survey before the rehabilitation treatment. Video camera to have 90-degree angle capability. Provide one DVD/USB copy of the survey and a survey log.	Lump Sum	1	2082	2082
4	Perform comprehensive well cleaning program. Amount to include all associated costs such as: materials, equipment, and labor; as wells as coordination & inspection charges, and markups. Proposal to provide step-by step summary of cleaning methods with recommended materials, quantities, and hours needed for cleaning operations.	Lump Sum	1	10879	10879
5	Estimated hours and cost for sand pumping sediment from bottom of hole. (Provide hourly unit cost in case additional sand pumping is required). Estimated Hours <u>4</u> Hourly Unit Cost \$ <u>240</u>	Lump Sum	1	240	960
6	Rig up and install temporary pumping equipment, neutralize water and pump well until the water is relatively clear and acceptable pH. Also include costs associated with any permitting and erosion control.	Lump Sum	1	12321	12321
7	Conduct color well video survey following completion of the rehabilitation treatment. Video camera to have 90-degree angle capability. Provide one DVD/USB copy of the survey and a survey log.	Lump Sum	1	2082	2082
8	Cost for new submersible pump recommended by contractor for existing well conditions (design of approximately 118 gpm / at a TDH of 1200 feet) including all testing and freight fees. Lump sum cost to include a one year warranty.	Lump Sum	1	11031	11031
9	Cost for new submersible motor that is compatible with the new recommended pump, including a one year warranty.	Lump Sum	1	20177	20177

ADDENDUM 1

10	New 4 1/2" (OD) J55 drop pipe	Foot	1321	20.96	27694
11	Cost to supply compatible replacement seal section or motor protector for the new pump and motor, also including a one year warranty.	Lump Sum	1	9454	9454
12	Charges for all equipment installation including all banding supplies, new airlines, new motor lead if needed, and splicing supplies for additional motor cable. Also charges for any modifications needed to shroud; or replacement of shroud if existing shroud is not compatible with the new motor; and any other modifications to other equipment as needed. Also charges for the well disinfection and start-up.	Lump Sum	1	16775	16775
13	Trade-in value for existing pumping equipment. Deduct the trade-in value amount from the bid total (amount should reflect any shipping and handling charges)	Lump Sum	1	0	0

ONE HUNDRED TWENTY TWO THOUSAND FIFTY EIGHT DOLLARS
 Total Base Bid in Words for CR-84 (A)

\$ 122,058
 Total Base Bid in Figures (A)

Optional Quote for Well CR-84

	Task Description	Unit	Quantity	Unit Price	Total
1	Provide tank and dispose of cleaning fluid from well outside of Town Limits (if sanitary sewer is unavailable for disposal)	Lump Sum	1	6000	6000
2	Disposal of existing drop pipe	Lump Sum	1	0	0

SIX THOUSAND DOLLARS
 Total Optional Bid in Words for CR-84 (a)

\$ 6,000
 Total Optional Bid in Figures (a)

\$ 128,058.00
 Total Bid in Figures (A+a)

ADDENDUM 1

Quote for Well CR-105 Well Rehabilitation and Pumping Equipment Replacement

Please complete quote pricing for the following tasks:

	Task Description	Unit	Quantity	Unit Price	Total
1	Mobilization, traffic control plan and permitting (if required)	Lump Sum	1	2550	2550
2	Pull existing equipment	Lump Sum	1	7285	7285
3	Conduct color well video survey before the rehabilitation treatment. Video camera to have 90-degree angle capability. Provide one DVD/USB copy of the survey and a survey log.	Lump Sum	1	2407	2407
4	Perform comprehensive well cleaning program. Amount to include all associated costs such as: materials, equipment, and labor; as wells as coordination & inspection charges, and markups. Proposal to provide step-by-step summary of cleaning methods with recommended materials, quantities, and hours needed for cleaning operations.	Lump Sum	1	25145	25145
5	Estimated hours and cost for sand pumping sediment from bottom of hole. (Provide hourly unit cost in case additional sand pumping is required). Estimated Hours <u>4</u> Hourly Unit Cost \$ <u>240</u>	Lump Sum	1	240	960
6	Rig up and install temporary pumping equipment, neutralize water and pump well until the water is relatively clear and acceptable pH. Also include costs associated with any permitting and erosion control.	Lump Sum	1	14185	14185
7	Conduct color well video survey following completion of the rehabilitation treatment. Video camera to have 90-degree angle capability. Provide one DVD/USB copy of the survey and a survey log.	Lump Sum	1	2407	2407
8	Cost for new submersible pump recommended by contractor for existing well conditions (design of approximately 250 gpm / at a TDH of 1690 feet) including all testing and freight fees. Lump sum cost to include a one year warranty.	Lump Sum	1	17924	17924
9	Cost for new submersible motor that is compatible with the new recommended pump, including a one year warranty.	Lump Sum	1	29219	29219
10	New 4 1/2" (OD) J55 drop pipe	Foot	1782	2068	36851
11	Cost to supply compatible replacement seal section or motor protector for the	Lump Sum	1	9454	9454

ADDENDUM 1

	new pump and motor, also including a one year warranty.				
12	Charges for all equipment installation including all banding supplies, new airlines, new motor lead if needed, and splicing supplies for additional motor cable. Also charges for any modifications needed to shroud; or replacement of shroud if existing shroud is not compatible with the new motor; and any other modifications to other equipment as needed. Also charges for the well disinfection and start-up.	Lump Sum	1	19650	19650
13	Trade-in value for existing pumping equipment. Deduct the trade-in value amount from the bid total (amount should reflect any shipping and handling charges)	Lump Sum	1	0	0

ONE HUNDRED SIXTY EIGHT THOUSAND AND THIRTY EIGHT DOLLARS

Total Base Bid in Words for CR-105 (B)

\$ 168,038.00

Total Base Bid in Figures (B)

Optional Quote for Well CR-105

	Task Description	Unit	Quantity	Unit Price	Total
1	Provide tank and dispose of cleaning fluid from well outside of Town Limits (if sanitary sewer is unavailable for disposal)	Lump Sum	1	6000	6000
2	Disposal of existing drop pipe	Lump Sum	1	0	0

ONE HUNDRED SEVENTY FOUR THOUSAND THIRTY EIGHT DOLLARS

Total Optional Bid in Words for CR-105 (b)

\$ 6,000.00

Total Optional Bid in Figures (b)

\$ 174,038.00

Total Bid in Figures (B+b)

ADDENDUM 1

Quote for Well CR-111 Well Rehabilitation and Pumping Equipment Replacement

Please complete quote pricing for the following tasks:

	Task Description	Unit	Quantity	Unit Price	Total
1	Mobilization, traffic control plan and permitting (if required)	Lump Sum	1	2550	2550
2	Pull existing equipment	Lump Sum	1	7285	7285
3	Conduct color well video survey before the rehabilitation treatment. Video camera to have 90-degree angle capability. Provide one DVD/USB copy of the survey and a survey log.	Lump Sum	1	2407	2407
4	Perform comprehensive well cleaning program. Amount to include all associated costs such as: materials, equipment, and labor; as wells as coordination & inspection charges, and markups. Proposal to provide step-by step summary of cleaning methods with recommended materials, quantities, and hours needed for cleaning operations.	Lump Sum	1	23711	23711
5	Estimated hours and cost for sand pumping sediment from bottom of hole. (Provide hourly unit cost in case additional sand pumping is required). Estimated Hours <u>4</u> Hourly Unit Cost \$ <u>240</u>	Lump Sum	1	240	960
6	Rig up and install temporary pumping equipment, neutralize water and pump well until the water is relatively clear and acceptable pH. Also include costs associated with any permitting and erosion control.	Lump Sum	1	14185	14185
7	Conduct color well video survey following completion of the rehabilitation treatment. Video camera to have 90-degree angle capability. Provide one DVD/USB copy of the survey and a survey log.	Lump Sum	1	2407	2407
8	Cost for new submersible pump recommended by contractor for existing well conditions (design of approximately 460 gpm / at a TDH of 2018 feet) including all testing and freight fees. Lump sum cost to include a one year warranty.	Lump Sum	1	24525	24525
9	Cost for new submersible motor that is compatible with the new recommended pump, including a one year warranty.	Lump Sum	1	41102	41102
10	New 7" (OD) SST drop pipe	Foot	1592	103.59	164908
11	Cost to supply compatible replacement seal section or motor protector for the	Lump Sum	1	9454	9454

ADDENDUM I

	new pump and motor, also including a one year warranty.				
12	Charges for all equipment installation including all banding supplies, new airlines, new motor lead if needed, and splicing supplies for additional motor cable. Also charges for any modifications needed to shroud; or replacement of shroud if existing shroud is not compatible with the new motor; and any other modifications to other equipment as needed. Also charges for the well disinfection and start-up.	Lump Sum	1	22880	22880
13	Trade-in value for existing pumping equipment. Deduct the trade-in value amount from the bid total (amount should reflect any shipping and handling charges)	Lump Sum	1	0	0
14	SST Check Valve	Lump Sum	1	3836	3836

THREE HUNDRED TWENTY THOUSAND TWO HUNDRED TEN DOLLARS
 Total Base Bid in Words for CR-111 (C)

\$ 320,210.⁰⁰
 Total Base Bid in Figures (C)

Optional Quote for Well CR-111

	Task Description	Unit	Quantity	Unit Price	Total
1	Provide tank and dispose of cleaning fluid from well outside of Town Limits (if sanitary sewer is unavailable for disposal)	Lump Sum	1	6000	6000
2	Disposal of existing drop pipe	Lump Sum	1	0	0

THREE HUNDRED TWENTY SIX THOUSAND TWO HUNDRED TEN DOLLARS
 Total Optional Bid in Words for CR-111 (c)

\$ 6000.⁰⁰
 Total Optional Bid in Figures (c)

\$ 326,210.⁰⁰
 Total Bid in Figures (C+c)

ADDENDUM 1

Quote for Well CR-123 Well Rehabilitation and Pumping Equipment Replacement

Please complete quote pricing for the following tasks:

	Task Description	Unit	Quantity	Unit Price	Total
1	Mobilization, traffic control plan and permitting (if required)	Lump Sum	1	2550	2550
2	Pull existing equipment	Lump Sum	1	7285	7285
3	Conduct color well video survey before the rehabilitation treatment. Video camera to have 90-degree angle capability. Provide one DVD/USB copy of the survey and a survey log.	Lump Sum	1	2407	2407
4	Perform comprehensive well cleaning program. Amount to include all associated costs such as: materials, equipment, and labor; as wells as coordination & inspection charges, and markups. Proposal to provide step-by step summary of cleaning methods with recommended materials, quantities, and hours needed for cleaning operations.	Lump Sum	1	19105	19105
5	Estimated hours and cost for sand pumping sediment from bottom of hole. (Provide hourly unit cost in case additional sand pumping is required). Estimated Hours <u>4</u> Hourly Unit Cost \$ <u>240</u>	Lump Sum	1	240	960
6	Rig up and install temporary pumping equipment, neutralize water and pump well until the water is relatively clear and acceptable pH. Also include costs associated with any permitting and erosion control.	Lump Sum	1	14322	14322
7	Conduct color well video survey following completion of the rehabilitation treatment. Video camera to have 90-degree angle capability. Provide one DVD/USB copy of the survey and a survey log.	Lump Sum	1	2407	2407
8	Cost for new submersible pump recommended by contractor for existing well conditions (design of approximately 350 gpm / at a TDH of 1620 feet) including all testing and freight fees. Lump sum cost to include a one year warranty.	Lump Sum	1	20725	20725
9	Cost for new submersible motor that is compatible with the new recommended pump, including a one year warranty.	Lump Sum	1	30926	30926
10	New 5 ½" (OD) J55 drop pipe	Foot	2109	<u>28.02</u>	<u>59092</u>

ADDENDUM 1

11	Cost to supply compatible replacement seal section or motor protector for the new pump and motor, also including a one year warranty.	Lump Sum	1	9454	9454
12	Charges for all equipment installation including all banding supplies, new airlines, new motor lead if needed, and splicing supplies for additional motor cable. Also charges for any modifications needed to shroud; or replacement of shroud if existing shroud is not compatible with the new motor; and any other modifications to other equipment as needed. Also charges for the well disinfection and start-up.	Lump Sum	1	21050	21050
13	Trade-in value for existing pumping equipment. Deduct the trade-in value amount from the bid total (amount should reflect any shipping and handling charges)	Lump Sum	1	0	0

ONE HUNDRED NINETY THOUSAND TWO HUNDRED EIGHTY THREE DOLLARS

Total Base Bid in Words for CR-123 (D)

\$ 190,283.⁰⁰

Total Base Bid in Figures (D)

Optional Quote for Well CR-123

	Task Description	Unit	Quantity	Unit Price	Total
1	Provide tank and dispose of cleaning fluid from well outside of Town Limits (if sanitary sewer is unavailable for disposal)	Lump Sum	1	6000	6000
2	Disposal of existing drop pipe	Lump Sum	1	0	0

ONE HUNDRED NINETY SIX THOUSAND TWO HUNDRED EIGHTY THREE DOLLARS

Total Optional Bid in Words for CR-123 (d)

\$ 6,000.⁰⁰

Total Optional Bid in Figures (d)

\$ 196,283.⁰⁰

Total Bid in Figures (D+d)

ADDENDUM 1

Quote for Bell Mountain Well Investigation

Please complete quote pricing for the following tasks:

	Task Description	Unit	Quantity	Unit Price	Total
BMR DA-1 Well Permit No. 57960-F					
1	Mobilization, traffic control plan and permitting (if required)	Lump Sum	1	110	110
2	Pull existing equipment	Lump Sum	1	3840	3840
3	Conduct color well video survey before the rehabilitation treatment. Video camera to have 90-degree angle capability. Provide one DVD/USB copy of the survey and a survey log.	Lump Sum	1	1451	1451
4	Charges for all equipment re-installation, well disinfection, and start-up.	Lump Sum	1	3871	3871
BMR D-1 Well Permit No. 57961-F					
5	Mobilization, traffic control plan and permitting (if required)	Lump Sum	1	390	390
6	Pull existing equipment	Lump Sum	1	6462	6462
7	Conduct color well video survey before the rehabilitation treatment. Video camera to have 90-degree angle capability. Provide one DVD/USB copy of the survey and a survey log.	Lump Sum	1	1729	1729
8	Charges for all equipment re-installation, well disinfection, and start-up.	Lump Sum	1	8942	8942
BMR A-1 Well Permit No. 57962-F					
9	Mobilization, traffic control plan and permitting (if required)	Lump Sum	1	390	390
10	Pull existing equipment	Lump Sum	1	7078	7078
11	Conduct color well video survey before the rehabilitation treatment. Video camera to have 90-degree angle capability. Provide one DVD/USB copy of the survey and a survey log.	Lump Sum	1	1954	1954
12	Charges for all equipment re-installation, well disinfection, and start-up.	Lump Sum	1	9548	9548

FORTY FIVE THOUSAND SEVEN HUNDRED SIXTY FIVE DOLLARS

Total Base Bid in Words for Bell Mountain Well Investigation (E)

\$ 45,765.⁰⁰

Total Base Bid in Figures (E)

EIGHT HUNDRED FORTY SIX THOUSAND THREE HUNDRED FIFTY FOUR DOLLARS
Total Base Bid in Words (A+B+C+D+E)

Scott Martin 9/14/23
Signature and Date

\$ 846,354.00
Total Base Bid in Figures(A+B+C+D+E)

TWENTY FOUR THOUSAND DOLLARS
Total Optional Bid in Words (a+b+c+d)

Scott Martin 9/14/23
Signature and Date

\$ 24,000.00
Total Optional Bid in Figures(a+b+c+d)

EIGHT HUNDRED SEVENTY THOUSAND THREE HUNDRED FIFTY FOUR DOLLARS
Total Bid in Words (A+a+B+b+C+c+D+d+E)

Scott Martin 9/14/23
Signature and Date

\$ 870,354.00
Total Base Bid in Figures (A+a+B+b+C+c+D+d+E)

**Estimated Start Date OCTOBER 2023

**Estimated Completion Date MARCH 2024

BID BOND

Applied Ingenuity, LLC 14920 Harvest Road, Brighton, CO 80603,
 (insert the full name and address or legal title of the Contractor) as Principal,
 and, Contractors Bonding and Insurance Company
 (insert the legal title of the Surety) as Surety, a corporation organized under the laws of the State of
Illinois, and authorized to transact business in the State of Colorado, with a
 general office at 9025 N. Lindbergh Drive, Peoria, IL 61615,
 are hereby bound to the Town of Castle Rock, Colorado, (Town) as Obligee, in the amount of
Five Percent (5%) of Total Amount Bid 5% DOLLARS,

in United States currency, for the payment of which amount the Contractor and Surety bind themselves,
 their heirs, executors, administrators, successors, and assigns, jointly and severally. The Principal has
 submitted the accompanying Bid dated the 15th day of September, 2023, for construction of the
2023/2024 Denver Basin Rehabilitation and Pumping Equipment Replacement Project Project contract.

The Town requires, as a condition for receiving the Bid, that the Principal deposit with the Town a Bid
 Guaranty, of at least five percent of the amount of the Bid, conditioned so that if the Principal fails to
 execute the Agreement for Construction Contract, and furnish the required Bonds if the Principal is
 awarded the Contract, that the sum be paid immediately to the Town, as liquidated damages and not as a
 penalty, for the Principal's failure to perform.

If the Principal, within the specified period, executes the Agreement for Construction Contract with the
 Town according to the Bid, as accepted, and furnishes a Performance Bond and a Labor and Material
 Payment Bond with good and sufficient Surety or Sureties, upon the forms prescribed by the Town for the
 faithful performance and proper fulfillment of the Contract, or pays to the Town the proper amount of
 liquidated damages, then this obligation shall be null and void; otherwise it shall remain in full force and
 effect.

Executed this 15th day of September, 2023.

WITNESS *Jill Nesbich*

PRINCIPAL Applied Ingenuity, LLC

BY: *Fred Scott Martin*
Fred Scott Martin, Its President

WITNESS *K'Anne E. Vogel*
 K'Anne E. Vogel, Witness to Surety

SURETY Contractors Bonding and Insurance Company

BY: *Christina L. Townsend*
Christina L. Townsend, Its Attorney-in-Fact

I, Christina L. Townsend, certify that I
 am the Attorney-in-Fact (title) of the Corporation named as Surety; that
Fred Scott Martin, Who signed the bond on behalf of the Principal, was
 then President (title) of the Corporation; that I know his or her signature, and the signature
 thereto is genuine; and that the bond was duly signed, sealed, and attested to for and on behalf of the
 Corporation by authority of this governing body.

(CORPORATE SEAL)

Signed: *Christina L. Townsend*

Title: Christina L. Townsend, Attorney-in-Fact



POWER OF ATTORNEY

RLI Insurance Company Contractors Bonding and Insurance Company

9025 N. Lindbergh Dr. Peoria, IL 61615
Phone: 800-645-2402

Know All Men by These Presents:

That this Power of Attorney is not valid or in effect unless attached to the bond which it authorizes executed, but may be detached by the approving officer if desired.

That **RLI Insurance Company** and/or **Contractors Bonding and Insurance Company**, each an Illinois corporation, (separately and together, the "Company") do hereby make, constitute and appoint:

Timothy J. Blanchard, Christina L. Townsend, Jennifer J. Walker, Barbara J. Arnold, Robert Charles Torrez, Nikki M. Mosbrucker, Ashley K. Anderson, Lynn Christine Bosman, K Anne E. Vogel, Nicole Lee McGuire, Andrew P. Walters, jointly or severally

in the City of Denver, State of Colorado its true and lawful Agent(s) and Attorney(s) in Fact, with full power and authority hereby conferred, to sign, execute, acknowledge and deliver for and on its behalf as Surety, in general, any and all bonds and undertakings in an amount not to exceed Twenty Five Million Dollars (\$25,000,000.00) for any single obligation.

The acknowledgment and execution of such bond by the said Attorney in Fact shall be as binding upon the Company as if such bond had been executed and acknowledged by the regularly elected officers of the Company.

RLI Insurance Company and/or **Contractors Bonding and Insurance Company**, as applicable, have each further certified that the following is a true and exact copy of a Resolution adopted by the Board of Directors of each such corporation, and is now in force, to-wit:

"All bonds, policies, undertakings, Powers of Attorney or other obligations of the corporation shall be executed in the corporate name of the Company by the President, Secretary, any Assistant Secretary, Treasurer, or any Vice President, or by such other officers as the Board of Directors may authorize. The President, any Vice President, Secretary, any Assistant Secretary, or the Treasurer may appoint Attorneys in Fact or Agents who shall have authority to issue bonds, policies or undertakings in the name of the Company. The corporate seal is not necessary for the validity of any bonds, policies, undertakings, Powers of Attorney or other obligations of the corporation. The signature of any such officer and the corporate seal may be printed by facsimile."

IN WITNESS WHEREOF, the **RLI Insurance Company** and/or **Contractors Bonding and Insurance Company**, as applicable, have caused these presents to be executed by its respective Vice President with its corporate seal affixed this 1st day of August, 2023.



RLI Insurance Company
Contractors Bonding and Insurance Company

By: Barton W. Davis Vice President

State of Illinois }
County of Peoria } SS

CERTIFICATE

On this 1st day of August, 2023, before me, a Notary Public, personally appeared Barton W. Davis, who being by me duly sworn, acknowledged that he signed the above Power of Attorney as the aforesaid officer of the **RLI Insurance Company** and/or **Contractors Bonding and Insurance Company** and acknowledged said instrument to be the voluntary act and deed of said corporation.

I, the undersigned officer of **RLI Insurance Company** and/or **Contractors Bonding and Insurance Company**, do hereby certify that the attached Power of Attorney is in full force and effect and is irrevocable; and furthermore, that the Resolution of the Company as set forth in the Power of Attorney, is now in force. In testimony whereof, I have hereunto set my hand and the seal of the **RLI Insurance Company** and/or **Contractors Bonding and Insurance Company** this 15th day of September, 2023.

By: Catherine D. Geiger
Catherine D. Geiger Notary Public

RLI Insurance Company
Contractors Bonding and Insurance Company
By: Jeffrey D. Fick Corporate Secretary

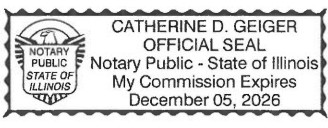

ADDENDUM 1

NON-COLLUSION AFFIDAVIT OF PRIME BIDDER

State of Colorado)
County of Adams)^{ss}

that: Fred Scott Martin , Being duly sworn deposes and says
(Insert name)

1. he/she is the President (Title) of Applied Ingenuity, LLC
the Bidder that has submitted the attached Bid;

2. He/She is fully informed respecting the preparation and content of the attached Bid and of all pertinent circumstances respecting such Bid;

3. Such Bid is genuine and is not a collusive or sham Bid:

4. Neither the Bidder nor any of its officers, partners, owners, agents, representatives, employees or parties in interest, including this affiant, has in any way colluded, conspired, connived or agreed, directly or indirectly with any other Bidder, subcontractor, mechanic, materialman, suppliers, firm or person to submit a collusive or sham Bid in connection with the Contract for which the attached Bid has been submitted, or to refrain from bidding in connection with such Contract, or has in any manner, directly or indirectly, sought agreement, collusion, communication or conference in the attached Bid or any other Bidder, or to fix any overhead, profit or cost element of the Bid price or the Bid price of any other Bidder, or to secure through any collusion, conspiracy, connivance or unlawful agreement any advantage against the Town of Castle Rock or any person interested in the proposed Contract; and

5. The price or prices quoted in the attached Bid are fair and proper and are not tainted by any collusion, conspiracy, connivance or unlawful agreement on the part of the Bidder or any of its agents, representatives, owners, employees or parties in interest, subcontractor, mechanic, materialman, suppliers, including this affiant.

CONTRACTOR: Applied Ingenuity, LLC BY: Fred Scott Martin *[Signature]*

ADDRESS: 14920 Harvest Rd. TITLE: President
Brighton, Co. 80603

Attest: SECRETARY: _____ DATE: 9/14/23
(if corporation)

(SEAL)

SUBCONTRACTORS AND RELATED DATA

For each Subcontractor to be utilized please provide the following information (use additional sheets as necessary):

Firm Name: N/A
Address: _____
Proposed work and percentage of total work to be assigned: _____
_____ Percentage _____%

Firm Name: _____
Address: _____
Proposed work and percentage of total work to be assigned: _____
_____ Percentage _____%

Firm Name: _____
Address: _____
Proposed work and percentage of total work to be assigned: _____
_____ Percentage _____%

Firm Name: _____
Address: _____
Proposed work and percentage of total work to be assigned: _____
_____ Percentage _____%

Firm Name: _____
Address: _____
Proposed work and percentage of total work to be assigned: _____
_____ Percentage _____%

Firm Name: _____
Address: _____
Proposed work and percentage of total work to be assigned: _____
_____ Percentage _____%



Town of Castle Rock
Castle Rock Water Department
175 Kellogg Court
Castle Rock, CO 80109
720-733-6000

REQUESTS FOR PROPOSALS CONFIDENTIALITY

Proposals submitted to the Town for consideration shall be subject to the Colorado Open Records Law, Section 24- 72-201, et seq., C.R.S. Any confidential information in the Submitter's proposal shall be identified as such. If any information is considered to be confidential, the Submitter shall agree to indemnify the Town for any and all attorney fees that the Town may incur in defending the withholding of such information by signing and returning the letter found in Section _____ of this RFP. Should the Town receive a request for the release of any information in the consultant's proposal in accordance with the Open Records Law, the Town will release only that information which has not been identified as confidential so long as the Letter of Indemnification has been signed and returned by the Submitter along with the proposal. Should the Submitter choose not to sign and return Letter of Indemnification, all information in the Submitter's proposal shall be considered releasable by the Town. Submitter will be notified of any open records requests prior to the release of such information. If, in the opinion of Town's legal counsel, the Town is nonetheless compelled to disclose any portion of such information to anyone or else stand liable for contempt or suffer censure or penalty, the Town may disclose such information without liability.



Town of Castle Rock
Castle Rock Water Department
175 Kellogg Court
Castle Rock, CO 80109
720-733-6000

**LETTER OF INDEMNIFICATION
FOR WITHHOLDING CONFIDENTIAL INFORMATION**

Re: Request under the Colorado Open Records Act

Request for Proposal Number: ITB-2023-01

Proposals submitted by consultants in response to the Town of Castle Rock’s Request for Proposal are subject to the Colorado Open Records Act. Should the Town receive a request for the release of any information in the Submitter’s proposal in accordance with the Open Records Law, the Town will review the Submitter’s proposal, giving consideration to the portions that the Submitter indicated contained trade secrets, privileged information, or confidential commercial, financial, geological, or geophysical data, and may release only that information which has not been identified as confidential and/or proprietary in your proposal pursuant to C.R.S. 24-72-201. If in the opinion of the Town’s legal counsel, the Town is nonetheless compelled to disclose any portion of such information to anyone or else stand liable for contempt or suffer censure or penalty, the Town may disclose such information without liability.

By having an authorized officer of the company sign below, Submitter agrees to the aforementioned waiver of liability and to indemnify the Town of Castle Rock for any and all attorney fees that the Town may incur in defending the withholding of such information.

Applied Ingenuity, LLC.
Submitter (Vendor or Business Name)

By: Fred Scott Martin
Signature

Fred Scott Martin
Name (please print)

President
Title

9/14/2023
Date

Pump Specifications Data Sheet

Project Information			
Customer Name:		Project Name:	
Region:		Part Number:	500022431-NSF01
Field Name:		Document Number:	
Well Name:		Revision:	
ITEM	DESCRIPTION	VALUES	DOCUMENT REFERENCE
1	General Parameters:		
1.1	Model and Name	PMP 538P L SSD 24 FLEX47 M PW NSF_PNT VT	
1.2	Size	538	
1.2.1	Diameter	5.38 in.	
1.2.2	Length	6.9 ft.	
1.3	Weight	345 lbs.	
2	Performance Ratings:		
2.1	Expected Efficiency @ BEP	72%	
2.2	Head / Stage (feet) @ BEP	51 ft.	
2.3	Target BEP Flow Rate	4700 BPD or 137 GPM	
2.4	Flow Rate Range	70 - 175 GPM	
2.5	Max Shaft HP/ Stage @ 60 Hz	2.6 HP	
3	Basic Type Materials:		
3.1	Pump housings	Carbon Steel	
3.2	Intake	Carbon Steel	
3.3	Bushing	Ni-Resist	
3.4	Housing O-ring seals	CL180	
3.5	Shaft	Monel	
3.6	Shaft Key	Monel	
3.7	Fastener	Monel	
3.8	Impeller Key	Monel	
3.9	Impeller	Ni-Resist	
3.10	Diffuser	Ni-Resist	
3.11	Coupling	Stainless Steel	
4	Design Features:		
4.1	Configurations (S, LT, MT, UT)	Lower Tandem (LT)	
4.2	Construction Type	Tungsten carbide (AR) bushings; 1:3 ratio	
4.4	Options	1:1 or 1:3 AR bushings	
4.5	Equipment Connected on Top	Pump discharge, Carbon Steel, Bolt-On 3.5" 8RD EUE	
4.6	Equipment Connected on bottom	GSB3DB Seal	
4.7	Exterior Coatings	NSF Approved Epoxy and Paint	
5	Performance Level/Testing:		
5.1	Factory Acceptance Testing	Per API 11S2	
5.2			
5.3			
5.4			

REMARKS (special requirements)

BKR Potable Water ESP systems are certified to industry standard certifications NSF/ANSI 61 and NSF/ANSI 372 for use in the United States and Canada Only.

Seal Specifications Data Sheet

Project Information			
Customer Name:		Project Name:	
Region:		Part Number:	500020686-NSF01
Field Name:		Document Number:	
Well Name:		Revision:	
ITEM	DESCRIPTION	VALUES	DOCUMENT REFERENCE
1	General Parameters:		
1.1	Model and Name	SEAL GS3 S CS B/L/L CNSF5 NSF_PNT PW VT	
1.2	Size	513	
1.2.1	Diameter	5.13 in	
1.2.2	Length	6.3 ft	
1.3	Weight	263 lbs	
1.4	Configuration	Bag/Lab/Lab	
2	Basic Type Materials:		
2.1	Head/Base	Carbon Steel	
2.2	Bushings	Bronze	
2.3	Housing	Carbon Steel	
2.4	Thrust Bearing	High Load Bearing	
2.5	Bag	Sealest	
2.6	Oil	CNSF5	
2.7	Shaft	Inconel	
2.8	O-Rings/Housing	Monel	
2.9	Fasteners	Monel	
2.10	Check Valves	Stainless Steel	
2.11	Fill and Vent Ports	Stainless Steel	
3	Design Features		
3.1	Configurations (Single, LT, UT)	Single	
3.2	Oil Type	CNSF5	
3.6	Exterior Coating	NSF certified epoxy coating	

REMARKS (special requirements)

Baker Hughes Potable Water ESP systems are certified to industry standard certifications NSF/ANSI 61 and NSF/ANSI 372 for use in the United States and Canada Only.

513 Series Seal Bag/Lab/Lab

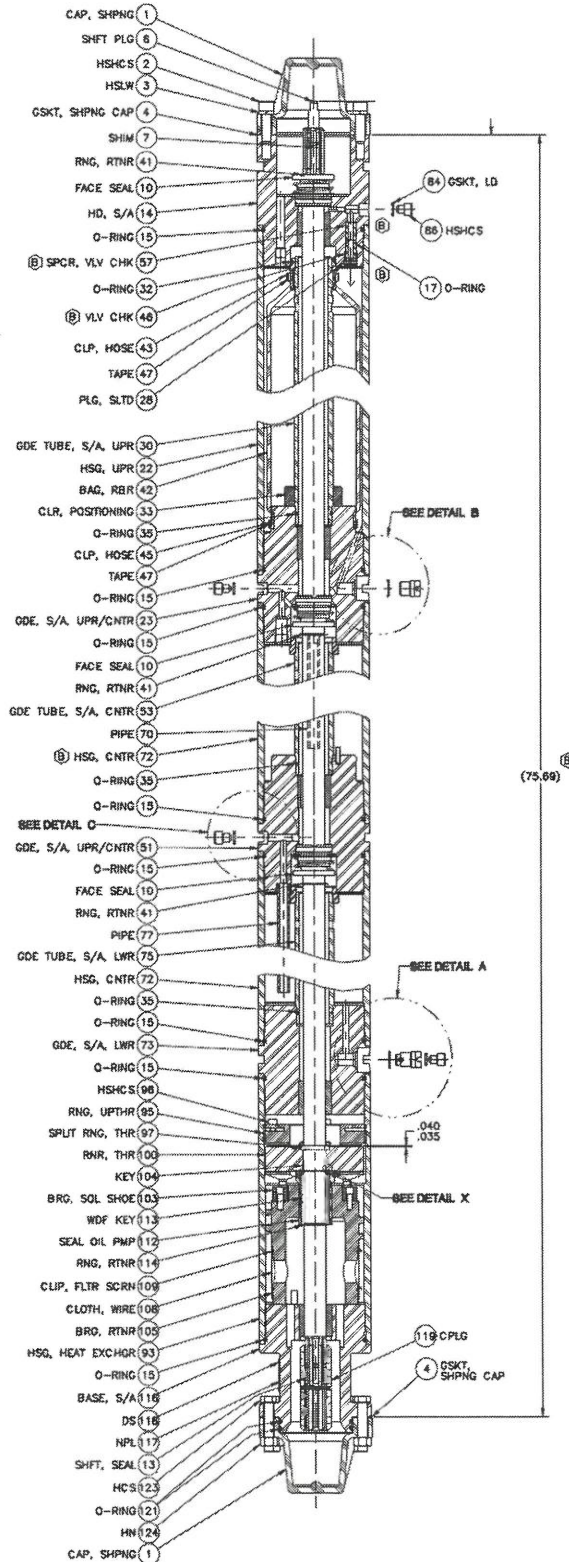

538 Series SSD FLEX47 Lower Tandem Pump

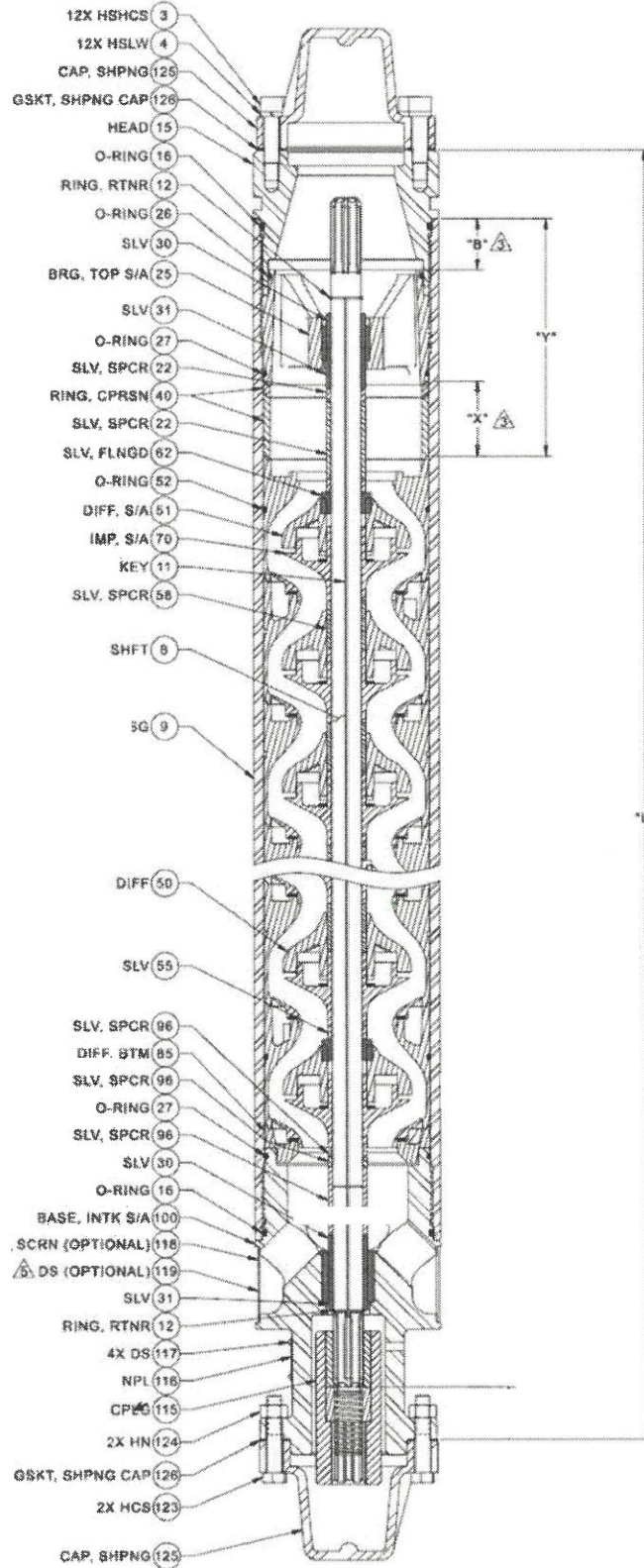

Motor Specifications Data Sheet

Project Information			
Customer Name:		Project Name:	
Region:		Part Number:	500018177-NSF01
Field Name:		Document Number:	
Well Name:		Revision:	
ITEM	DESCRIPTION	VALUES	DOCUMENT REFERENCE
1	General Parameters:		
1.1	Model and Name	MTR 562XP S CS 75/1365/34_03R NSF_PNT	
1.2	Size	562	
1.2.1	Diameter	5.62 in	
1.2.2	Length	6.8 ft	
1.3	Weight	519 lbs	
1.4	Number of Rotors	3R	
2	Performance Ratings:		
2.1	Horsepower per Rotor	25 HP	
2.2	Rated HP (nameplate)	75 HP @ 60Hz	
2.3	Rated Voltage (nameplate)	1365 V	
2.4	Rated Amps (nameplate)	34 A	
2.5	Full Load Efficiency	88%	
2.6	Full Load Power Factor	80%	
3	Basic Type Materials:		
3.1	Housing	Carbon Steel	
3.2	Head and Base	Carbon Steel	
3.3	Shaft	4130 S. Steel	
3.4	O-rings	CL180	
3.5	Fasteners	Monel	
3.6	Thrust Bearing	High Load Solid Shoe	
3.7	Fill valves	Stainless Steel	
3.8	Washers	Phenolic	
4	Design Features:		
4.1	Configurations (Single, LT, UT)	Single	
4.2	Oil Type (CL4, CL5, etc)	CNSF5	
4.4	Sensor (yes/no)		
4.5	Sensor type	N/A	
4.6	MWT sensor type (RTD, etc)	N/A	
4.7	Exterior Coating	NSF Approved Epoxy and Paint	
REMARKS (special requirements)			
BKR Potable Water ESP systems are certified to industry standard certifications NSF/ANSI 61 and NSF/ANSI 372 for use in the United States and Canada Only.			

562 Series SP/XP Motor Overview Drawing

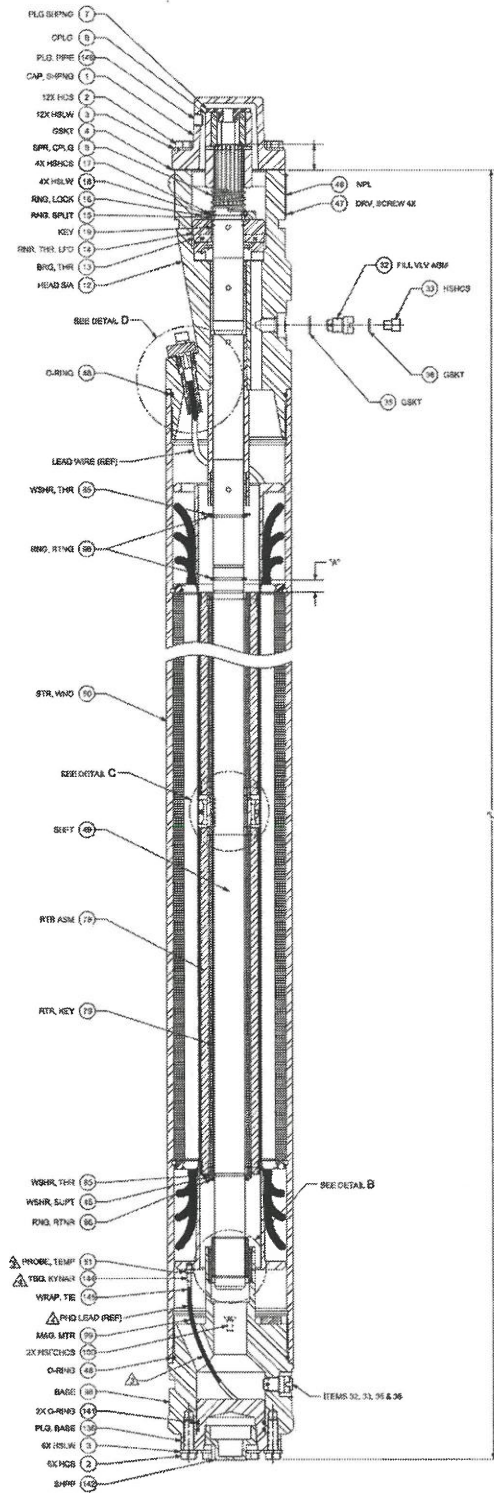

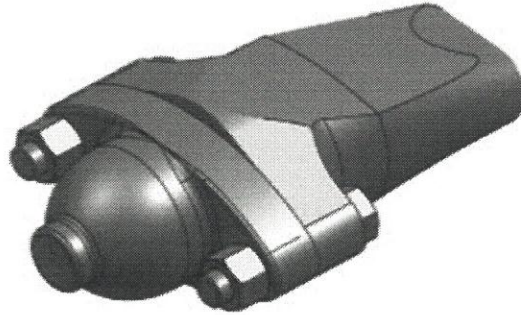

Model:	: CENTRILINK 20 4PHT 76381 400°F PW
Connector Type:	: Plug-In
Temperature Range:	: 400 °F
Conductor Size:	: AWG #4
Conductor Material:	: Copper SDBC
Voltage Rating:	: 5000 Volts (5KV)
Inner Block & Connector Sheath:	: Epoxy
O-Rings:	: EDPM-70 CL180
Insulation Material:	: Polypropylene
Jacket Material:	: Nitrile
A armor Material:	: Monel Armor 1/2" x 0.015"
Cable Profile:	: Flat
Cable Length:	: Optional lengths (55', 70', 110', 150')
Cable Dimensions:	: Thickness = 0.479"; Width = 1.146"

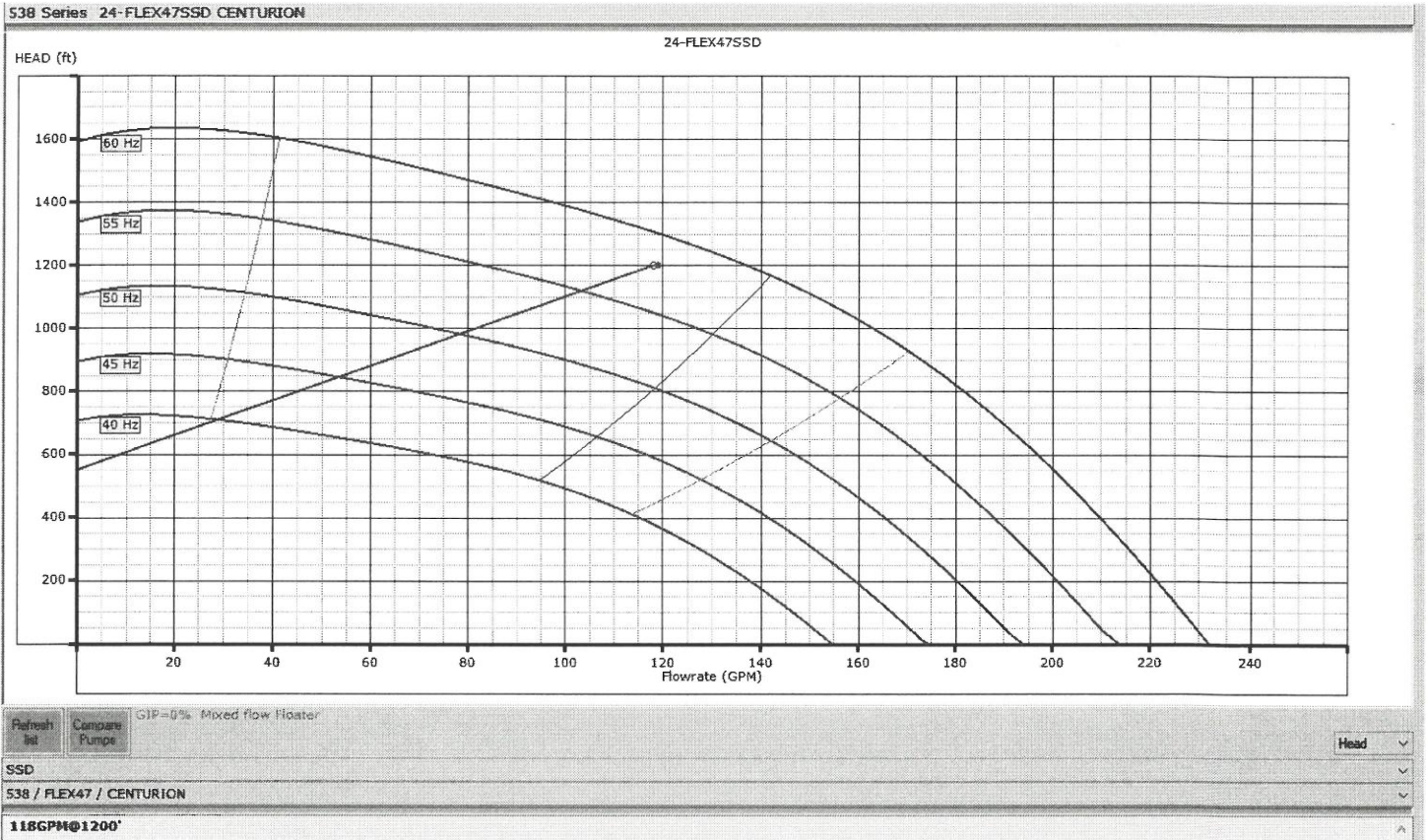

Pump Specifications Data Sheet

Project Information			
Customer Name:		Project Name:	
Region:		Part Number:	105150903-NSF01
Field Name:		Document Number:	
Well Name:		Revision:	
ITEM	DESCRIPTION	VALUES	DOCUMENT REFERENCE
1	General Parameters:		
1.1	Model and Name	PMP 538PLSSD 044 FLEX80 M PW NSF_PNT VT	
1.2	Size	538	
1.2.1	Diameter	5.38 in.	
1.2.2	Length	14.4 ft.	
1.3	Weight	665 lbs.	
2	Performance Ratings:		
2.1	Expected Efficiency @ BEP	77%	
2.2	Head / Stage (feet) @ BEP	77 ft.	
2.3	Target BEP Flow Rate	8000 BPD or 233 GPM	
2.4	Flow Rate Range	65 - 305 GPM	
2.5	Max Shaft HP/ Stage @ 60 Hz	7.8 HP	
3	Basic Type Materials:		
3.1	Pump housings	Carbon Steel	
3.2	Intake	Integral Carbon Steel	
3.3	Bushing	Ni-Resist and Tungsten Carbide	
3.4	Housing O-ring seals	CL180	
3.5	Shaft	Monel	
3.6	Shaft Key	Monel	
3.7	Fastener	Monel	
3.8	Impeller Key	Monel	
3.9	Impeller	Ni-Resist	
3.10	Diffuser	Ni-Resist	
3.11	Coupling	Stainless Steel	
4	Design Features:		
4.1	Configurations (S, LT, MT, UT)	Lower Tandem (LT)	
4.2	Construction Type	1:3 AR bushings	
4.4	Options	1:1, 1:3, or no AR bushings	
4.5	Equipment Connected on Top	Pump discharge, Carbon Steel, Bolt-On 3.5" 8RD EUE	
4.6	Equipment Connected on bottom	GSB3DB Seal	
4.7	Exterior Coatings	NSF Approved Epoxy and Paint	
5	Performance Level/Testing:		
5.1	Factory Acceptance Testing	Per API 11S2	
5.2			
5.3			
5.4			

REMARKS (special requirements)

Baker Hughes Potable Water ESP systems are certified to industry standard certifications NSF/ANSI 61 and NSF/ANSI 372 for use in the United States and Canada Only.

Seal Specifications Data Sheet

Project Information			
Customer Name:		Project Name:	
Region:		Part Number:	500020686-NSF01
Field Name:		Document Number:	
Well Name:		Revision:	
ITEM	DESCRIPTION	VALUES	DOCUMENT REFERENCE
1	General Parameters:		
1.1	Model and Name	SEAL GS3 S CS B/L/L CNSF5 NSF_PNT PW VT	
1.2	Size	513	
1.2.1	Diameter	5.13 in	
1.2.2	Length	6.3 ft	
1.3	Weight	263 lbs	
1.4	Configuration	Bag/Lab/Lab	
2	Basic Type Materials:		
2.1	Head/Base	Carbon Steel	
2.2	Bushings	Bronze	
2.3	Housing	Carbon Steel	
2.4	Thrust Bearing	High Load Bearing	
2.5	Bag	Sealest	
2.6	Oil	CNSF5	
2.7	Shaft	Inconel	
2.8	O-RingsHousing	Monel	
2.9	Fasteners	Monel	
2.10	Check Valves	Stainless Steel	
2.11	Fill and Vent Ports	Stainless Steel	
3	Design Features		
3.1	Configurations (Single, LT, UT)	Single	
3.2	Oil Type	CNSF5	
3.6	Exterior Coating	NSF certified epoxy coating	
REMARKS (special requirements)			
Baker Hughes Potable Water ESP systems are certified to industry standard certifications NSF/ANSI 61 and NSF/ANSI 372 for use in the United States and Canada Only.			

513 Series Seal
Bag/Lab/Lab

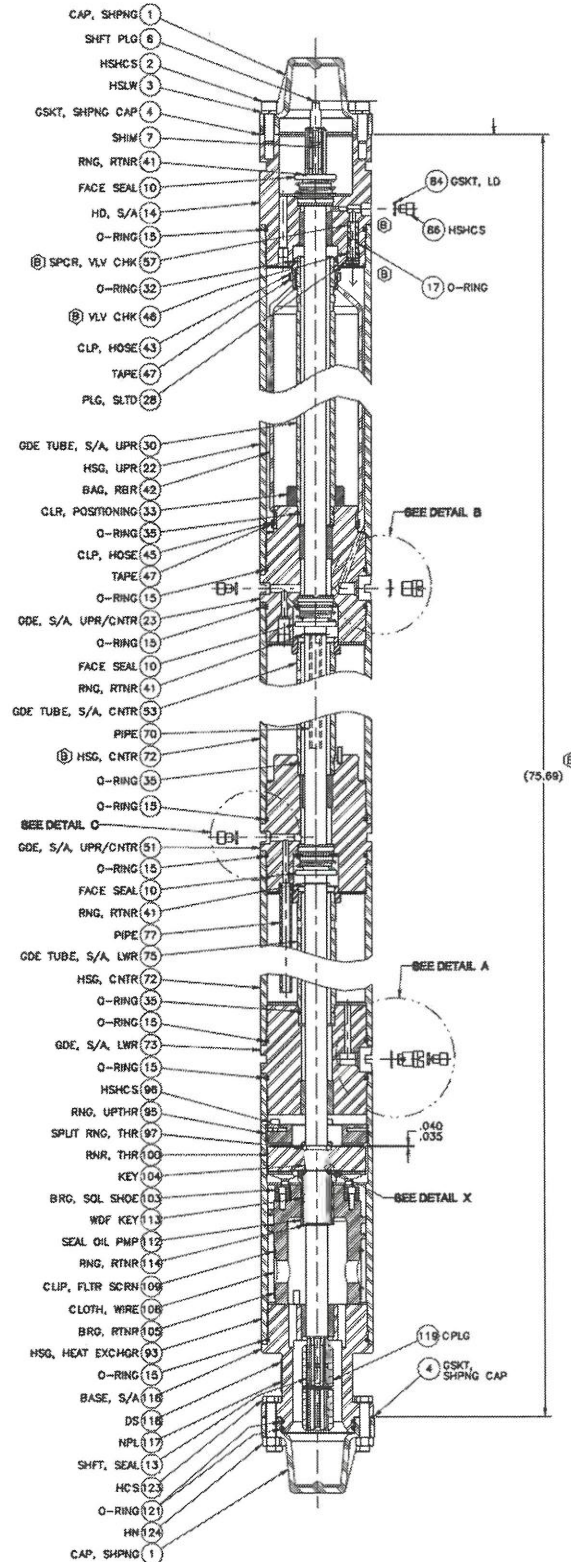

538 Series SSD FLEX80 Lower Tandem Pump

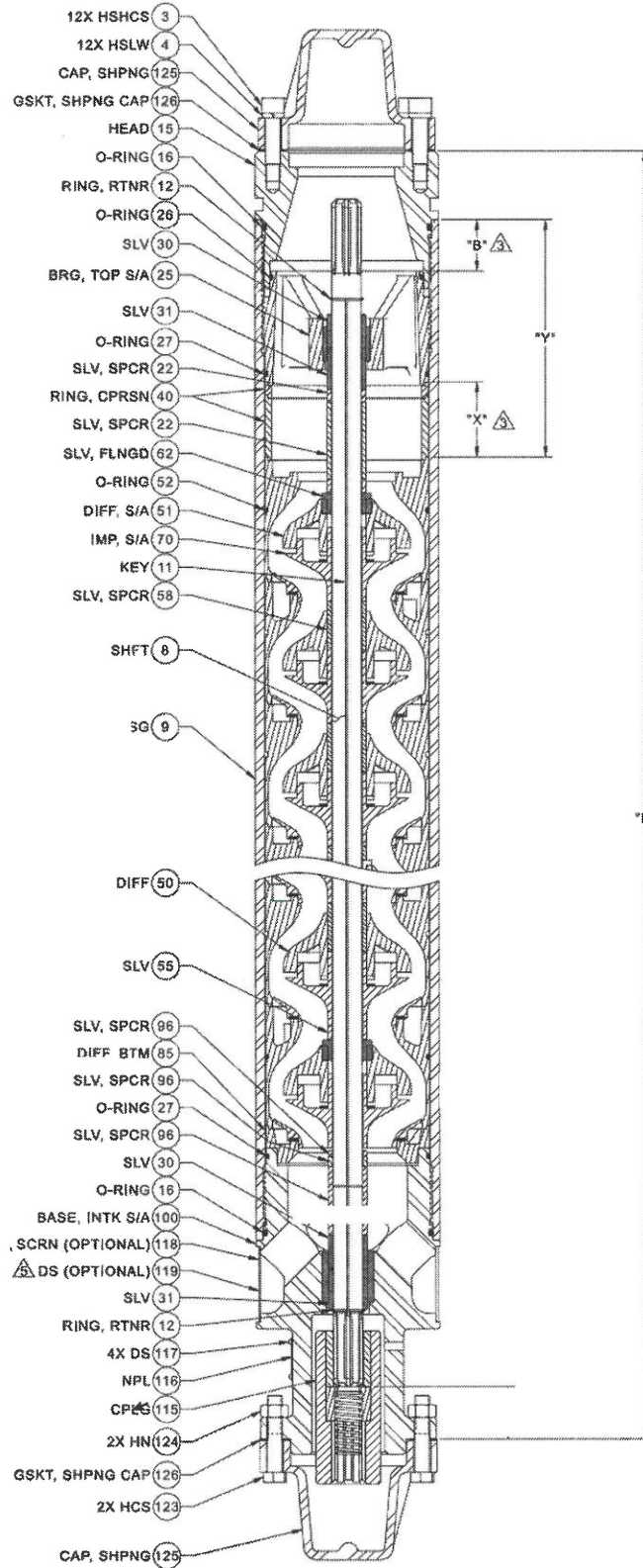

Motor Specifications Data Sheet

Project Information			
Customer Name:		Project Name:	
Region:		Part Number:	105151676-NSF01
Field Name:		Document Number:	
Well Name:		Revision:	
ITEM	DESCRIPTION	VALUES	DOCUMENT REFERENCE
1	General Parameters:		
1.1	Model and Name	562 XP 200HP 2300V 56A	
1.2	Size	562	
1.2.1	Diameter	5.62 in	
1.2.2	Length	14 ft	
1.3	Weight	1120 LBS	
1.4	Number of Rotors	8	
2	Performance Ratings:		
2.1	Horsepower per Rotor	25 HP	
2.2	Rated HP (nameplate)	200 HP @ 60Hz	
2.3	Rated Voltage (nameplate)	2300 V	
2.4	Rated Amps (nameplate)	56 A	
2.5	Full Load Efficiency	88%	
2.6	Full Load Power Factor	80%	
3	Basic Type Materials:		
3.1	Housing	Carbon Steel	
3.2	Head and Base	Carbon Steel	
3.3	Shaft	4130 S. Steel	
3.4	O-rings	CL180	
3.5	Fasteners	Monel	
3.6	Thrust Bearing	High Load Solid Shoe	
3.7	Fill valves	Stainless Steel	
3.8	Washers	Phenolic	
4	Design Features:		
4.1	Configurations (Single, LT, UT)	Single	
4.2	Oil Type (CL4, CL5, etc)	CNSF5	
4.4	Sensor (yes/no)		
4.5	Sensor type	N/A	
4.6	MWT sensor type (RTD, etc)	N/A	
4.7	Exterior Coating	NSF Amercoat 370	

REMARKS (special requirements)

--

562 Series SP/XP Motor Overview Drawing

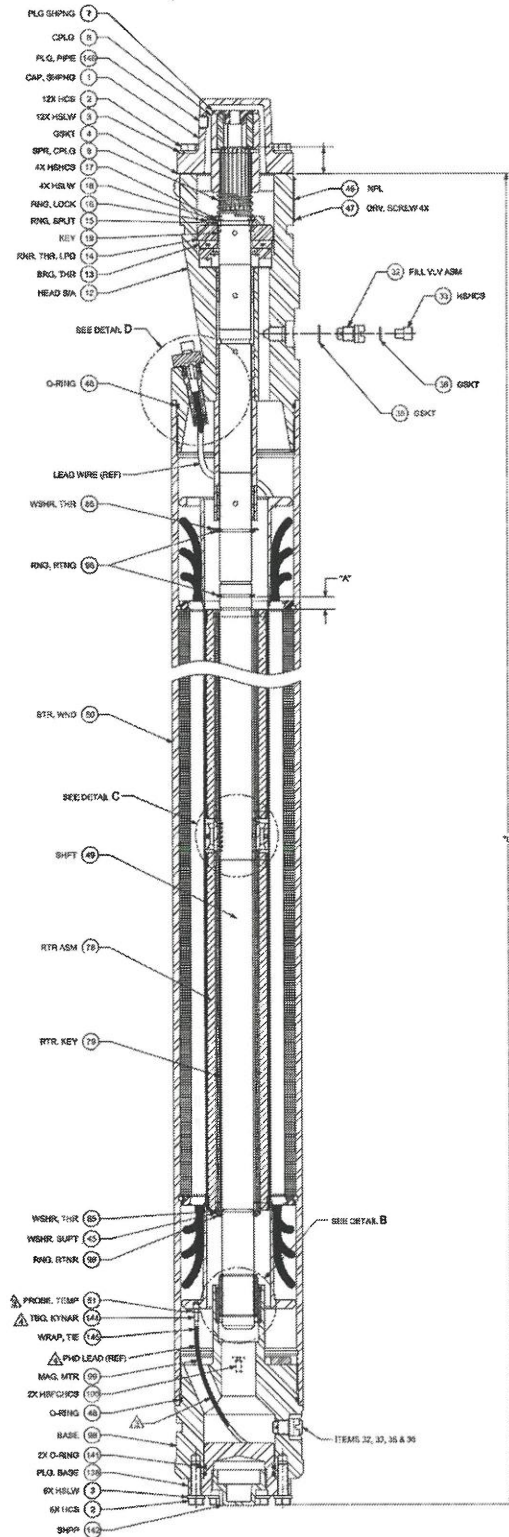

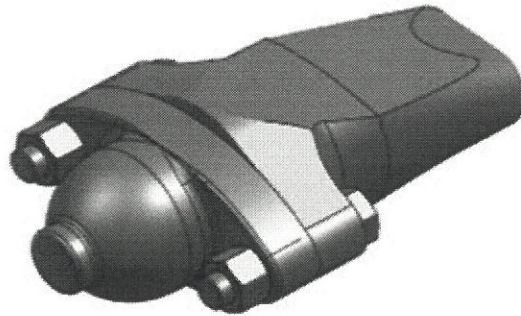

Model:	: CENTRILINK 20 4PHT 76381 400°F PW
Connector Type:	: Plug-In
Temperature Range:	: 400 °F
Conductor Size:	: AWG #4
Conductor Material:	: Copper SDBC
Voltage Rating:	: 5000 Volts (5KV)
Inner Block & Connector Sheath:	: Epoxy
O-Rings:	: EDPM-70 CL180
Insulation Material:	: Polypropylene
Jacket Material:	: Nitrile
Aarmor Material:	: Monel Armor 1/2" x 0.015"
Cable Profile:	: Flat
Cable Length:	: Optional lengths (55', 70', 110', 150')
Cable Dimensions:	: Thickness = 0.479"; Width = 1.146"

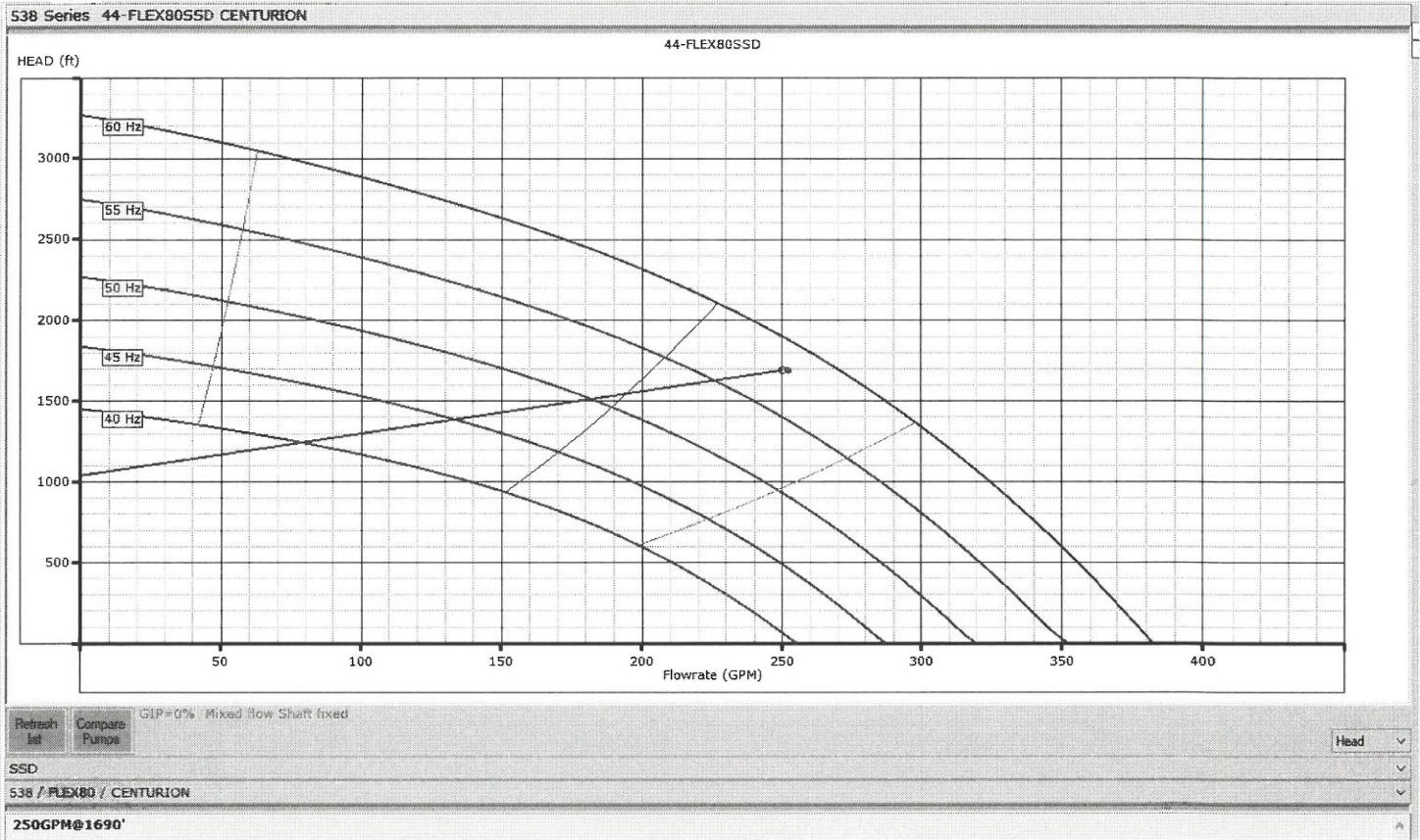

Well 111



Pump Specifications Data Sheet

Project Information			
Customer Name:		Project Name:	
Region:		Part Number:	10548940-NSF01
Field Name:		Document Number:	
Well Name:		Revision:	

ITEM	DESCRIPTION	VALUES	DOCUMENT REFERENCE
1	General Parameters:		
1.1	Model and Name	PMP HPHVLARC 26 HC20000 M PW GS 1:3	
1.2	Size	675	
1.2.1	Diameter	6.75 in.	
1.2.2	Length	13.1 ft.	
1.3	Weight	775 lbs.	
2	Performance Ratings:		
2.1	Expected Efficiency @ BEP	77%	
2.2	Head / Stage (feet) @ BEP	76 ft.	
2.3	Target BEP Flow Rate	20000 BPD or 585 GPM	
2.4	Flow Rate Range	290 - 670 GPM	
2.5	Max Shaft HP/ Stage @ 60 Hz	14.6 HP	
3	Basic Type Materials:		
3.1	Pump housings	Carbon Steel	
3.2	Intake	Carbon Steel	
3.3	Bushing	Tungsten Carbide and Ni-resist	
3.4	Housing O-ring seals	CL180	
3.5	Shaft	Monel	
3.6	Shaft Key	Monel	
3.7	Fastener	Monel	
3.8	Impeller Key	Monel	
3.9	Impeller	Ni-Resist	
3.10	Diffuser	Ni-Resist	
3.11	Coupling	Stainless Steel	
4	Design Features:		
4.1	Configurations (S, LT, MT, UT)	Lower Tandem (LT)	
4.2	Construction Type	1:3 AR	
4.4	Options	Ni-resist or 1:1, 1:3 AR bushings	
4.5	Equipment Connected on Top	Pump discharge, Carbon Steel, Thread 5.5" 8RD LTC	
4.6	Equipment Connected on bottom	500 series seal	
4.7	Exterior Coatings	Optional	
5	Performance Level/Testing:		
5.1			
5.2			
5.3			
5.4			

REMARKS (special requirements)

BKR Potable Water ESP systems are certified to industry standard certifications NSF/ANSI 61 and NSF/ANSI 372 for use in the United States and Canada Only.

Seal Specifications Data Sheet

Project Information			
Customer Name:		Project Name:	
Region:		Part Number:	500020686-NSF01
Field Name:		Document Number:	
Well Name:		Revision:	
ITEM	DESCRIPTION	VALUES	DOCUMENT REFERENCE
1	General Parameters:		
1.1	Model and Name	SEAL GS3 S CS B/L/L CNSF5 NSF_PNT PW VT	
1.2	Size	513	
1.2.1	Diameter	5.13 in	
1.2.2	Length	6.3 ft	
1.3	Weight	263 lbs	
1.4	Configuration	Bag/Lab/Lab	
2	Basic Type Materials:		
2.1	Head/Base	Carbon Steel	
2.2	Bushings	Bronze	
2.3	Housing	Carbon Steel	
2.4	Thrust Bearing	High Load Bearing	
2.5	Bag	Sealest	
2.6	Oil	CNSF5	
2.7	Shaft	Inconel	
2.8	O-Rings/Housing	Monel	
2.9	Fasteners	Monel	
2.10	Check Valves	Stainless Steel	
2.11	Fill and Vent Ports	Stainless Steel	
3	Design Features		
3.1	Configurations (Single, LT, UT)	Single	
3.2	Oil Type	CNSF5	
3.6	Exterior Coating	NSF certified epoxy coating	

REMARKS (special requirements)

Baker Hughes Potable Water ESP systems are certified to industry standard certifications NSF/ANSI 61 and NSF/ANSI 372 for use in the United States and Canada Only.

513 Series Seal Bag/Lab/Lab

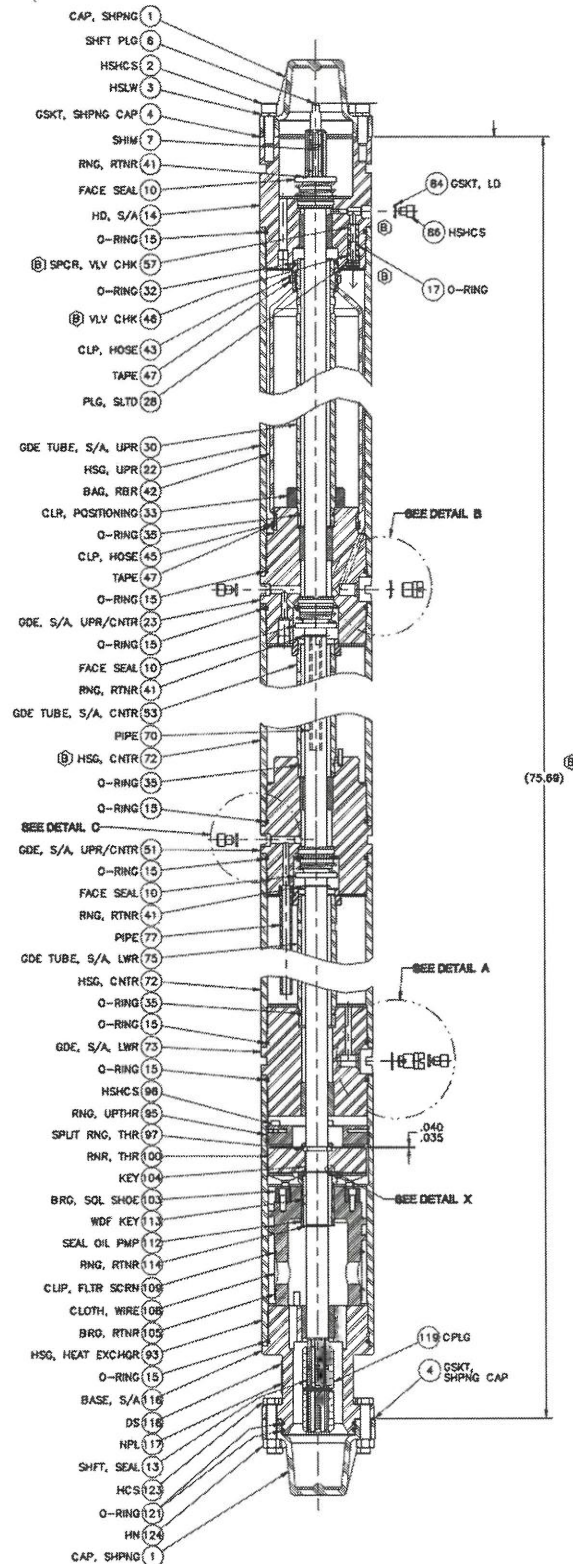

Motor Specifications Data Sheet

Project Information			
Customer Name:		Project Name:	
Region:		Part Number:	105161924-NSF01
Field Name:		Document Number:	
Well Name:		Revision:	
ITEM	DESCRIPTION	VALUES	DOCUMENT REFERENCE
1	General Parameters:		
1.1	Model and Name	MTR 562XP S CS 400/2380/103_16R NSF_PNT	
1.2	Size	562	
1.2.1	Diameter	5.62 in	
1.2.2	Length	25.4 ft	
1.3	Weight	2082 LBS	
1.4	Number of Rotors	16	
2	Performance Ratings:		
2.1	Horsepower per Rotor	25 HP	
2.2	Rated HP (nameplate)	400 HP @ 60Hz	
2.3	Rated Voltage (nameplate)	2380 V	
2.4	Rated Amps (nameplate)	103 A	
2.5	Full Load Efficiency	88%	
2.6	Full Load Power Factor	80%	
3	Basic Type Materials:		
3.1	Housing	Carbon Steel	
3.2	Head and Base	Carbon Steel	
3.3	Shaft	4130 S. Steel	
3.4	O-rings	CL180	
3.5	Fasteners	Monel	
3.6	Thrust Bearing	Solid Shoe	
3.7	Fill valves	Stainless Steel	
3.8	Washers	ALR142	
4	Design Features:		
4.1	Configurations (Single, LT, UT)	Single	
4.2	Oil Type (CL4, CL5, etc)	CNSF5	
4.4	Sensor (yes/no)		
4.5	Sensor type	N/A	
4.6	MWT sensor type (RTD, etc)	N/A	
4.7	Exterior Coating	NSF Approved Epoxy and Paint	
REMARKS (special requirements)			
Baker Hughes Potable Water ESP systems are certified to industry standard certifications NSF/ANSI 61 and NSF/ANSI 372 for use in the United States and Canada Only.			

562 Series SP/XP Motor Overview Drawing

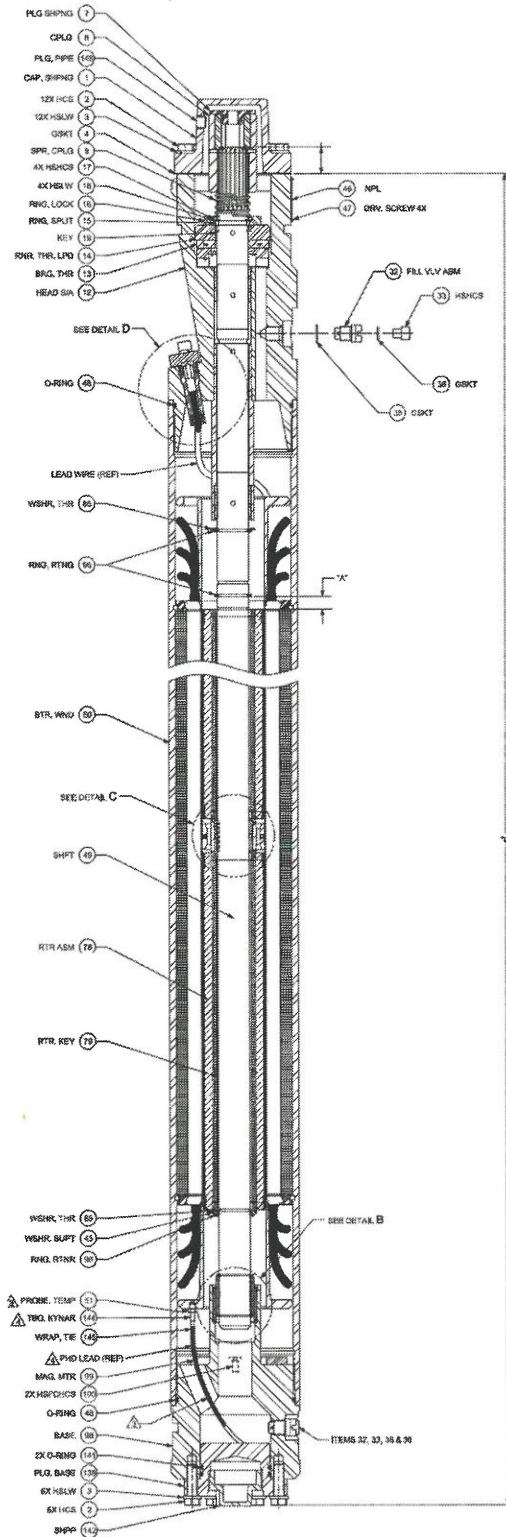

675 Series HC20000 LT Pump

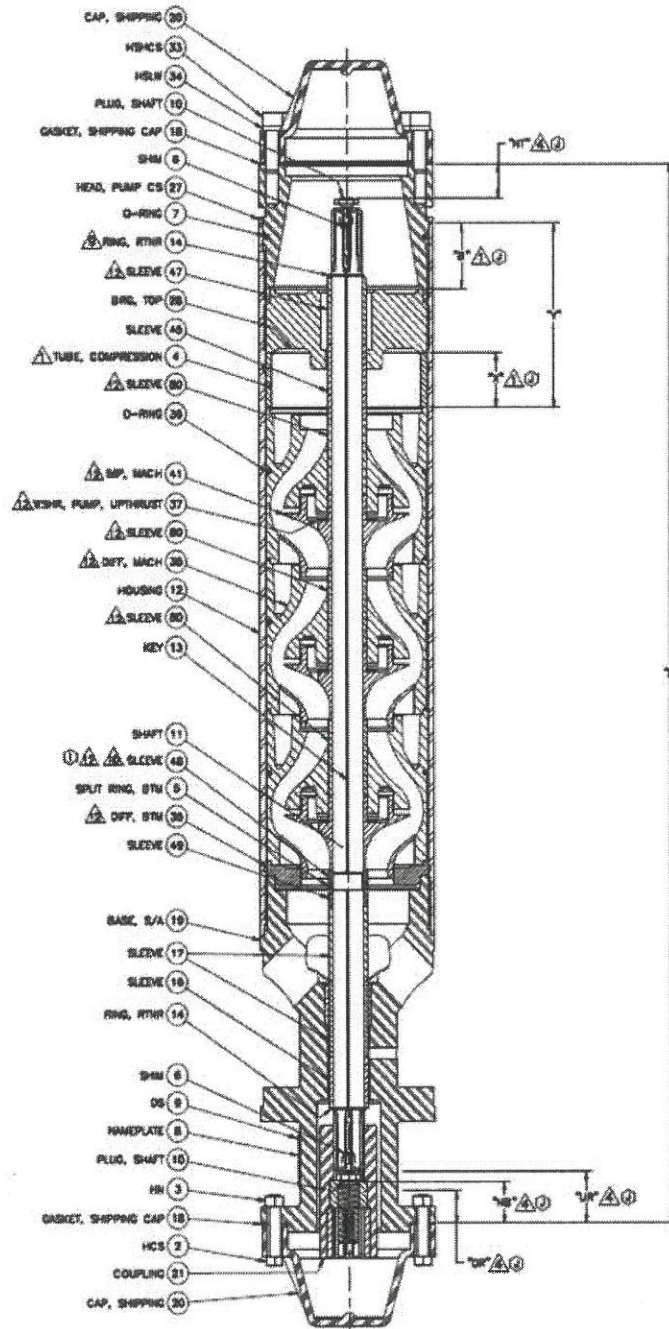

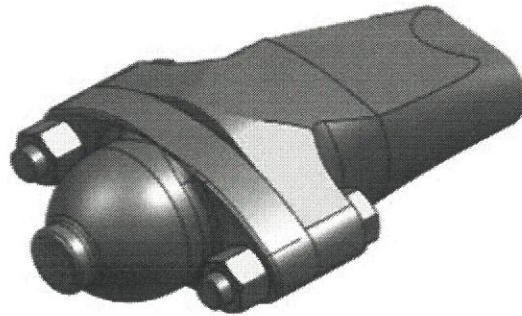

Model:	: CENTRILINK 20 4PHT 76381 400°F PW
Connector Type:	: Plug-In
Temperature Range:	: 400 °F
Conductor Size:	: AWG #4
Conductor Material:	: Copper SDBC
Voltage Rating:	: 5000 Volts (5KV)
Inner Block & Connector Sheath:	: Epoxy
O-Rings:	: EDPM-70 CL180
Insulation Material:	: Polypropylene
Jacket Material:	: Nitrile
Armor Material:	: Monel Armor 1/2" x 0.015"
Cable Profile:	: Flat
Cable Length:	: Optional lengths (55', 70', 110', 150')
Cable Dimensions:	: Thickness = 0.479"; Width = 1.146"



Pump Specifications Data Sheet

Project Information			
Customer Name:		Project Name:	
Region:		Part Number:	10601591-NSF01
Field Name:		Document Number:	
Well Name:		Revision:	
ITEM	DESCRIPTION	VALUES	DOCUMENT REFERENCE
1	General Parameters:		
1.1	Model and Name	PMP HPHVLARC 21 HC12500 M PW NSF_PNT VT	
1.2	Size	675	
1.2.1	Diameter	6.75 in.	
1.2.2	Length	11.6'	
1.3	Weight	770 lbs.	
2	Performance Ratings:		
2.1	Expected Efficiency @ BEP	78%	
2.2	Head / Stage (feet) @ BEP	85 ft.	
2.3	Target BEP Flow Rate	12500 BPD or 365 GPM	
2.4	Flow Rate Range	200 - 470 GPM	
2.5	Max Shaft HP/ Stage @ 60 Hz	10 HP	
3	Basic Type Materials:		
3.1	Pump housings	Carbon Steel	
3.2	Intake	Carbon Steel	
3.3	Bushing	Ni-Resist and Tungsten Carbide	
3.4	Housing O-ring seals	CL180	
3.5	Shaft	Monel	
3.6	Shaft Key	Monel	
3.7	Fastener	Monel	
3.8	Impeller Key	Monel	
3.9	Impeller	Ni-Resist	
3.10	Diffuser	Ni-Resist	
3.11	Coupling	Stainless Steel	
4	Design Features:		
4.1	Configurations (S, LT, MT, UT)	Lower Tandem (LT)	
4.2	Construction Type	Ni-Resist Sleeves with 1:3 AR bushings	
4.4	Options	1:1 or 1:3 AR bushings	
4.5	Equipment Connected on Top	Pump discharge, Carbon Steel, Thread 5.5" 8RD LTC	
4.6	Equipment Connected on bottom	GSB3DB Seal	
4.7	Exterior Coatings	NSF Paint	
5	Performance Level/Testing:		
5.1	Factory Acceptance Testing	Per API 11S2	
5.2			
5.3			
5.4			

REMARKS (special requirements)

BKR Potable Water ESP systems are certified to industry standard certifications NSF/ANSI 61 and NSF/ANSI 372 for use in the United States and Canada Only.

Seal Specifications Data Sheet

Project Information			
Customer Name:		Project Name:	
Region:		Part Number:	500020686-NSF01
Field Name:		Document Number:	
Well Name:		Revision:	
ITEM	DESCRIPTION	VALUES	DOCUMENT REFERENCE
1	General Parameters:		
1.1	Model and Name	SEAL GS3 S CS B/L/L CNSF5 NSF_PNT PW VT	
1.2	Size	513	
1.2.1	Diameter	5.13 in	
1.2.2	Length	6.3 ft	
1.3	Weight	263 lbs	
1.4	Configuration	Bag/Lab/Lab	
2	Basic Type Materials:		
2.1	Head/Base	Carbon Steel	
2.2	Bushings	Bronze	
2.3	Housing	Carbon Steel	
2.4	Thrust Bearing	High Load Bearing	
2.5	Bag	Sealest	
2.6	Oil	CNSF5	
2.7	Shaft	Inconel	
2.8	O-Rings/Housing	Monel	
2.9	Fasteners	Monel	
2.10	Check Valves	Stainless Steel	
2.11	Fill and Vent Ports	Stainless Steel	
3	Design Features		
3.1	Configurations (Single, LT, UT)	Single	
3.2	Oil Type	CNSF5	
3.6	Exterior Coating	NSF certified epoxy coating	

REMARKS (special requirements)

Baker Hughes Potable Water ESP systems are certified to industry standard certifications NSF/ANSI 61 and NSF/ANSI 372 for use in the United States and Canada Only.

513 Series Seal
Bag/Lab/Lab

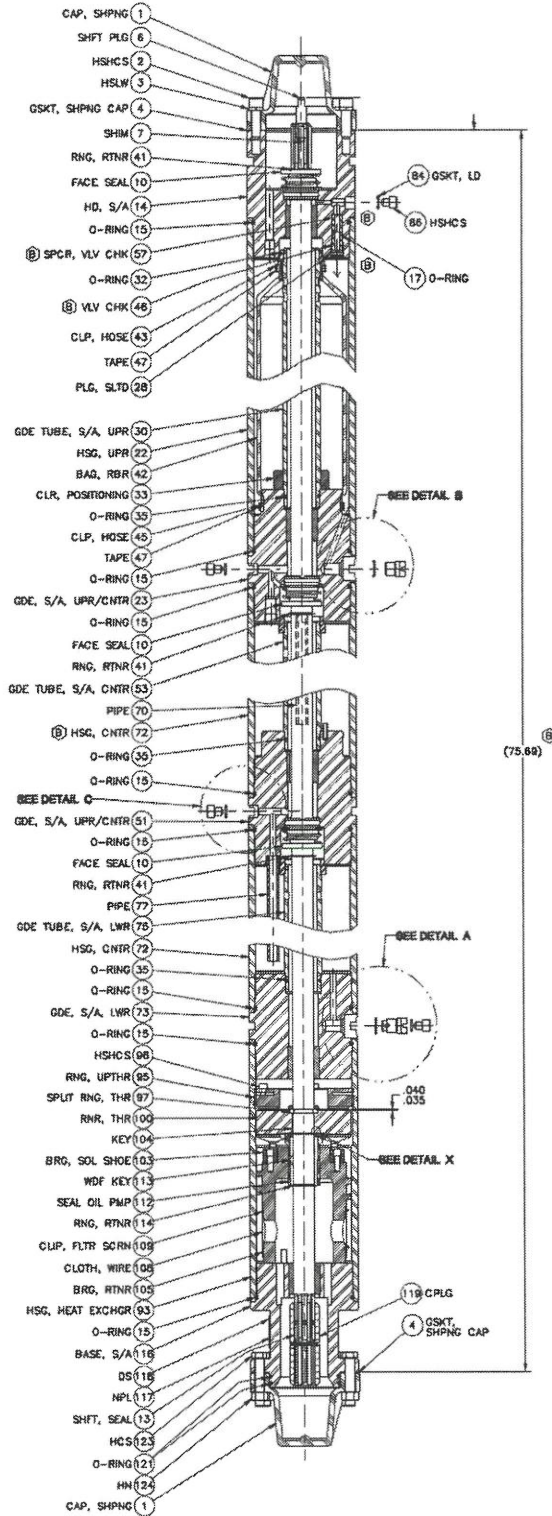

Motor Specifications Data Sheet

Project Information			
Customer Name:		Project Name:	
Region:		Part Number:	105151678-NSF01
Field Name:		Document Number:	
Well Name:		Revision:	
ITEM	DESCRIPTION	VALUES	DOCUMENT REFERENCE
1	General Parameters:		
1.1	Model and Name	MTR 562XP 250/2300/68 10R PW	
1.2	Size	562	
1.2.1	Diameter	5.62 in	
1.2.2	Length	16.8 ft	
1.3	Weight	1481 LBS	
1.4	Number of Rotors	10	
2	Performance Ratings:		
2.1	Horsepower per Rotor	25 HP	
2.2	Rated HP (nameplate)	250 HP @ 60Hz	
2.3	Rated Voltage (nameplate)	2300 V	
2.4	Rated Amps (nameplate)	68 A	
2.5	Full Load Efficiency	88%	
2.6	Full Load Power Factor	80%	
3	Basic Type Materials:		
3.1	Housing	Carbon Steel	
3.2	Head and Base	Carbon Steel	
3.3	Shaft	4130 S. Steel	
3.4	O-rings	CL180	
3.5	Fasteners	Monel	
3.6	Thrust Bearing	High Load Solid Shoe	
3.7	Fill valves	Stainless Steel	
3.8	Washers	ALR142	
4	Design Features:		
4.1	Configurations (Single, LT, UT)	Single	
4.2	Oil Type (CL4, CL5, etc)	CL5	
4.4	Sensor (yes/no)		
4.5	Sensor type	N/A	
4.6	MWT sensor type (RTD, etc)	N/A	
4.7	Exterior Coating	NSF Rated Epoxy Coating	
REMARKS (special requirements)			
Baker Hughes Potable Water ESP systems are certified to industry standard certifications NSF/ANSI 61 and NSF/ANSI 372 for use in the United States and Canada Only.			

562 Series SP/XP Motor Overview Drawing

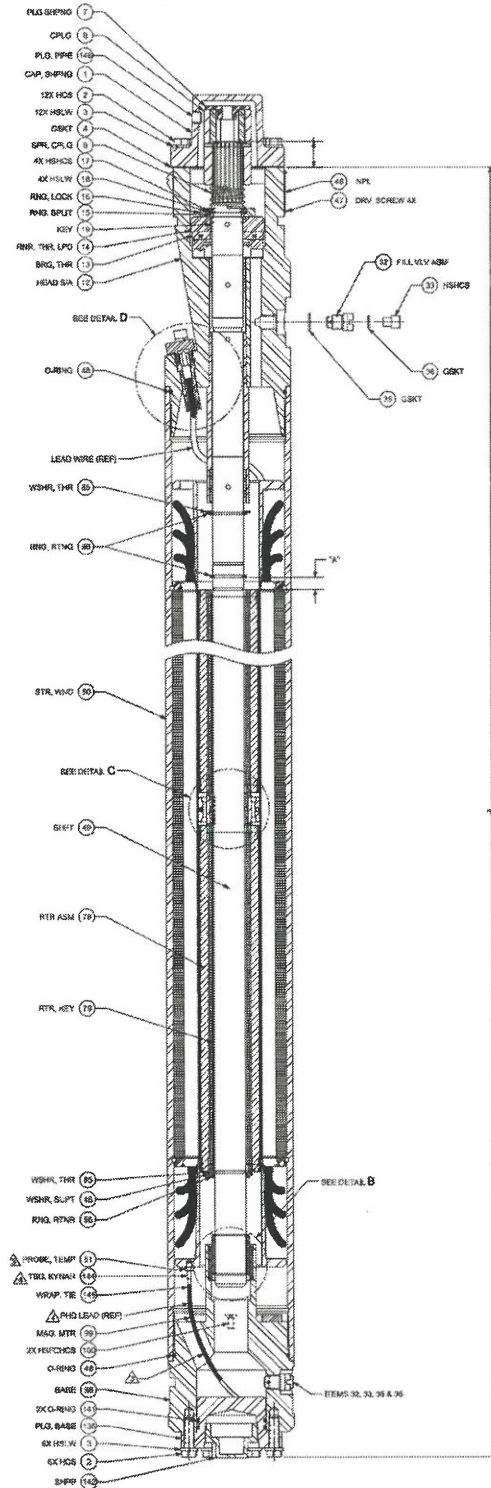

675 Series HC12500 Pump

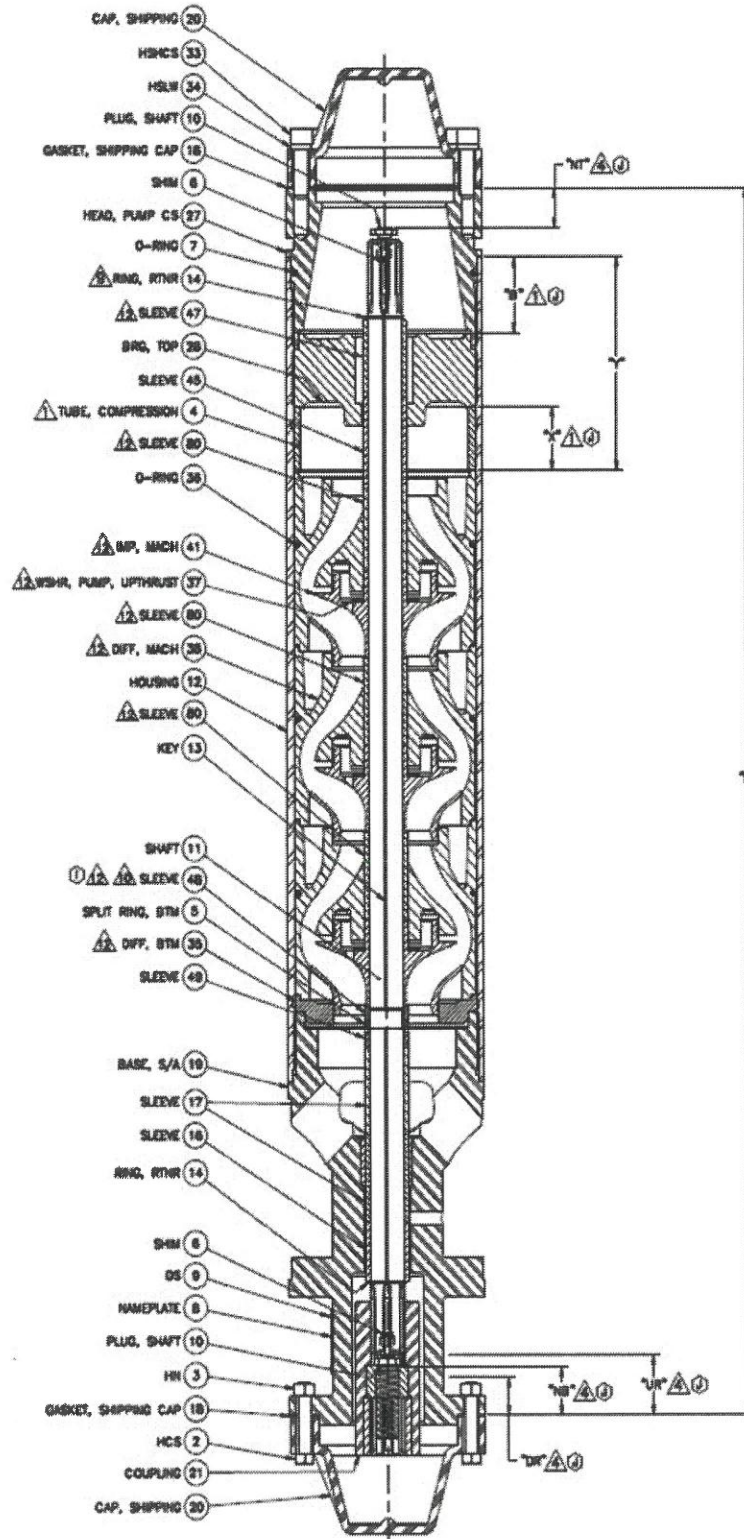

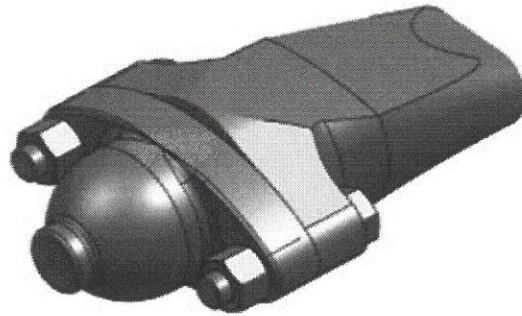

Model:	: CENTRILINK 20 4PHT 76381 400°F PW
Connector Type:	: Plug-In
Temperature Range:	: 400 °F
Conductor Size:	: AWG #4
Conductor Material:	: Copper SDBC
Voltage Rating:	: 5000 Volts (5KV)
Inner Block & Connector Sheath:	: Epoxy
O-Rings:	: EDPM-70 CL180
Insulation Material:	: Polypropylene
Jacket Material:	: Nitrile
Armor Material:	: Monel Armor 1/2" x 0.015"
Cable Profile:	: Flat
Cable Length:	: Optional lengths (55', 70', 110', 150')
Cable Dimensions:	: Thickness = 0.479"; Width = 1.146"

675 Series 21-HC12500 CENTRILIFT

21-HC12500

HEAD (ft)

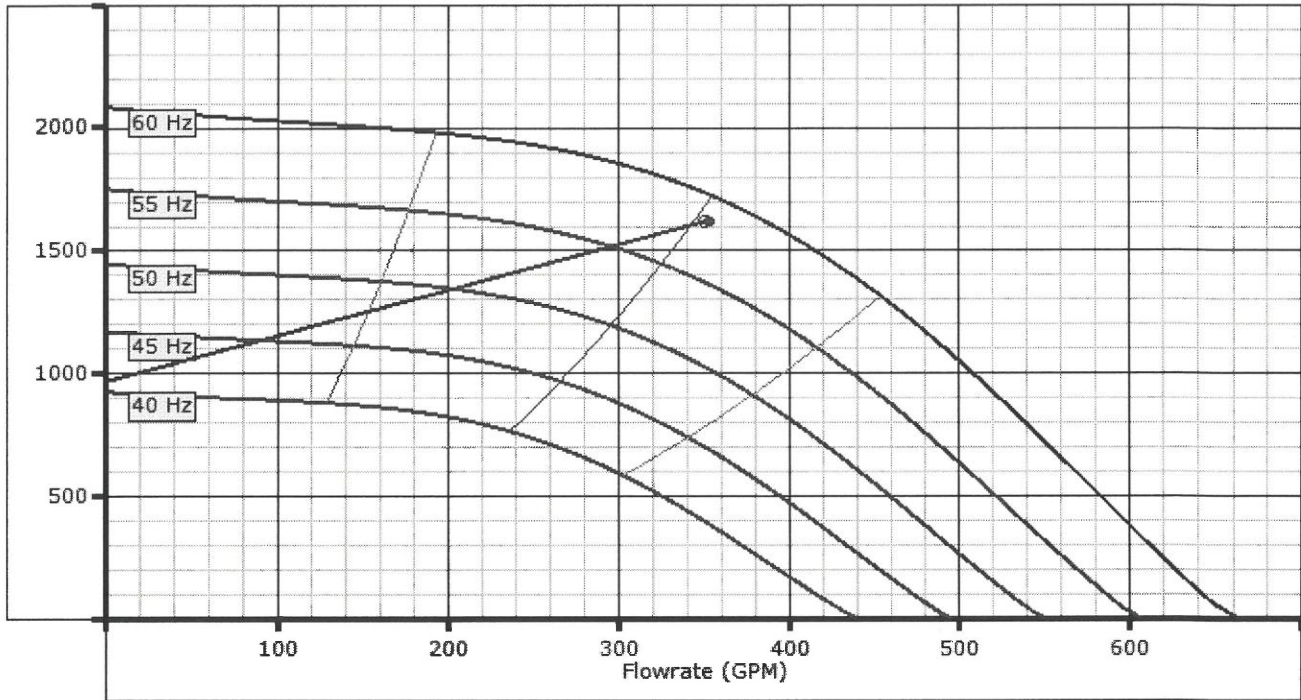

Refresh list

Compare Pumps

GIP=0% Mixed flow Shaft fixed

Head ▾

Standard ▾

675 / HC12500 / CENTRILIFT ▾

350GPM@1620' ▲



EXHIBIT 3

CONTRACTOR'S CERTIFICATE OF INSURANCE



CERTIFICATE OF LIABILITY INSURANCE

 DATE (MM/DD/YYYY)
10/13/2023

THIS CERTIFICATE IS ISSUED AS A MATTER OF INFORMATION ONLY AND CONFERS NO RIGHTS UPON THE CERTIFICATE HOLDER. THIS CERTIFICATE DOES NOT AFFIRMATIVELY OR NEGATIVELY AMEND, EXTEND OR ALTER THE COVERAGE AFFORDED BY THE POLICIES BELOW. THIS CERTIFICATE OF INSURANCE DOES NOT CONSTITUTE A CONTRACT BETWEEN THE ISSUING INSURER(S), AUTHORIZED REPRESENTATIVE OR PRODUCER, AND THE CERTIFICATE HOLDER.

IMPORTANT: If the certificate holder is an ADDITIONAL INSURED, the policy(ies) must have ADDITIONAL INSURED provisions or be endorsed. If SUBROGATION IS WAIVED, subject to the terms and conditions of the policy, certain policies may require an endorsement. A statement on this certificate does not confer rights to the certificate holder in lieu of such endorsement(s).

PRODUCER License # 0757776 HUB International Insurance Services (COL) 111 S Tejon Street Colorado Springs, CO 80903	CONTACT NAME: Terri Reese PHONE (A/C, No, Ext): (719) 884-0704 FAX (A/C, No): (866) 290-9290 E-MAIL ADDRESS: terri.reese@hubinternational.com <table style="width: 100%;"> <tr> <td style="text-align: center;">INSURER(S) AFFORDING COVERAGE</td> <td style="text-align: center;">NAIC #</td> </tr> <tr> <td>INSURER A: EMCASCO Insurance Co.</td> <td style="text-align: right;">21407</td> </tr> <tr> <td>INSURER B: Pinnacol Assurance Company</td> <td style="text-align: right;">41190</td> </tr> <tr> <td>INSURER C: Nautilus Insurance Company</td> <td style="text-align: right;">17370</td> </tr> <tr> <td>INSURER D:</td> <td></td> </tr> <tr> <td>INSURER E:</td> <td></td> </tr> <tr> <td>INSURER F:</td> <td></td> </tr> </table>	INSURER(S) AFFORDING COVERAGE	NAIC #	INSURER A: EMCASCO Insurance Co.	21407	INSURER B: Pinnacol Assurance Company	41190	INSURER C: Nautilus Insurance Company	17370	INSURER D:		INSURER E:		INSURER F:	
INSURER(S) AFFORDING COVERAGE	NAIC #														
INSURER A: EMCASCO Insurance Co.	21407														
INSURER B: Pinnacol Assurance Company	41190														
INSURER C: Nautilus Insurance Company	17370														
INSURER D:															
INSURER E:															
INSURER F:															

COVERAGES	CERTIFICATE NUMBER:	REVISION NUMBER:
------------------	----------------------------	-------------------------

THIS IS TO CERTIFY THAT THE POLICIES OF INSURANCE LISTED BELOW HAVE BEEN ISSUED TO THE INSURED NAMED ABOVE FOR THE POLICY PERIOD INDICATED. NOTWITHSTANDING ANY REQUIREMENT, TERM OR CONDITION OF ANY CONTRACT OR OTHER DOCUMENT WITH RESPECT TO WHICH THIS CERTIFICATE MAY BE ISSUED OR MAY PERTAIN, THE INSURANCE AFFORDED BY THE POLICIES DESCRIBED HEREIN IS SUBJECT TO ALL THE TERMS, EXCLUSIONS AND CONDITIONS OF SUCH POLICIES. LIMITS SHOWN MAY HAVE BEEN REDUCED BY PAID CLAIMS.

INSR LTR	TYPE OF INSURANCE	ADDL INSD	SUBR WVD	POLICY NUMBER	POLICY EFF (MM/DD/YYYY)	POLICY EXP (MM/DD/YYYY)	LIMITS	
A	<input checked="" type="checkbox"/> COMMERCIAL GENERAL LIABILITY CLAIMS-MADE <input type="checkbox"/> OCCUR <input checked="" type="checkbox"/>	X	X	6X17261	3/1/2023	3/1/2024	EACH OCCURRENCE	\$ 1,000,000
	GEN'L AGGREGATE LIMIT APPLIES PER: <input checked="" type="checkbox"/> POLICY <input type="checkbox"/> PRO-JECT <input type="checkbox"/> LOC OTHER:						DAMAGE TO RENTED PREMISES (Ea occurrence)	\$ 500,000
							MED EXP (Any one person)	\$ 10,000
							PERSONAL & ADV INJURY	\$ 1,000,000
							GENERAL AGGREGATE	\$ 2,000,000
							PRODUCTS - COMP/OP AGG	\$ 2,000,000
								\$
A	<input type="checkbox"/> ANY AUTO OWNED AUTOS ONLY <input checked="" type="checkbox"/> SCHEDULED AUTOS <input checked="" type="checkbox"/> HIRED AUTOS ONLY <input checked="" type="checkbox"/> NON-OWNED AUTOS ONLY	X	X	6X17261	3/1/2023	3/1/2024	COMBINED SINGLE LIMIT (Ea accident)	\$ 1,000,000
							BODILY INJURY (Per person)	\$
							BODILY INJURY (Per accident)	\$
							PROPERTY DAMAGE (Per accident)	\$
								\$
A	<input checked="" type="checkbox"/> UMBRELLA LIAB <input type="checkbox"/> EXCESS LIAB DEDED <input checked="" type="checkbox"/> RETENTION \$ 10,000			6X17261	3/1/2023	3/1/2024	EACH OCCURRENCE	\$ 5,000,000
							AGGREGATE	\$ 5,000,000
								\$
B	WORKERS COMPENSATION AND EMPLOYERS' LIABILITY ANY PROPRIETOR/PARTNER/EXECUTIVE OFFICER/MEMBER EXCLUDED? (Mandatory in NH) <input type="checkbox"/> Y / N <input checked="" type="checkbox"/> N / A If yes, describe under DESCRIPTION OF OPERATIONS below		X	4142675	10/1/2023	10/1/2024	<input checked="" type="checkbox"/> PER STATUTE <input type="checkbox"/> OTH-ER	\$
							E.L. EACH ACCIDENT	\$ 1,000,000
							E.L. DISEASE - EA EMPLOYEE	\$ 1,000,000
							E.L. DISEASE - POLICY LIMIT	\$ 1,000,000
C	Pollution Liability			CPL2013379-20	3/1/2023	3/1/2024	1,000,000 /	2,000,000

DESCRIPTION OF OPERATIONS / LOCATIONS / VEHICLES (ACORD 101, Additional Remarks Schedule, may be attached if more space is required)
 Town of Castle Rock, its elected and appointed officials, officers, employees, agents and volunteers acting within the course and scope of their duties for the Town are additional insureds under General Liability and Automobile Liability. A waiver of subrogation in favor of the additional insureds is applicable to General Liability, Automobile Liability and Workers Compensation.

CERTIFICATE HOLDER Town of Castle Rock Town Attorney 100 N. Wilcox Street Castle Rock, CO 80104	CANCELLATION SHOULD ANY OF THE ABOVE DESCRIBED POLICIES BE CANCELLED BEFORE THE EXPIRATION DATE THEREOF, NOTICE WILL BE DELIVERED IN ACCORDANCE WITH THE POLICY PROVISIONS. AUTHORIZED REPRESENTATIVE
--	--

THIS ENDORSEMENT CHANGES THE POLICY. PLEASE READ IT CAREFULLY.

GENERAL LIABILITY ELITE EXTENSION

This endorsement modifies insurance provided under the following:

COMMERCIAL GENERAL LIABILITY COVERAGE FORM

The COMMERCIAL GENERAL LIABILITY COVERAGE FORM is amended to include the following clarifications and extensions of coverage. The provisions of the Coverage Form apply unless modified by endorsement.

A. EXPECTED OR INTENDED INJURY

Section I – Coverage A, Exclusion **a.** is amended as follows:

- a. “Bodily injury” or “property damage” expected or intended from the standpoint of an insured. This exclusion does not apply to “bodily injury” or “property damage” resulting from the use of reasonable force to protect persons or property.

B. NON-OWNED WATERCRAFT

Section I – Coverage A, Exclusion **g.(2)** is amended as follows:

- (2) A watercraft you do not own that is:
 - (a) Less than 60 feet long; and
 - (b) Not being used to carry person(s) or property for a charge;

C. EXTENDED PROPERTY DAMAGE COVERAGE

Section I – Coverage A, Exclusions **j.(3)** and **(4)** is amended to add the following:

Paragraphs **(3)** and **(4)** of this exclusion do not apply to tools or equipment loaned to you, provided they are not being used to perform operations at the time of loss.

SCHEDULE	
Limits Of Insurance	Deductible
\$5,000 Each Occurrence	\$250 Per Claim
\$10,000 Annual Aggregate	

- a. The each occurrence limit listed above is the most we will pay for all damages because of “property damage” to property in the care, custody and control of or property loaned to an insured as the result of any one “occurrence”, regardless of the number of:
 - (1) insureds;
 - (2) claims made or “suits” brought;
 - (3) persons or organizations making claims or bringing “suits”.

The aggregate limit listed above is the most we will pay for all damages because of “property damage” to property in the care custody and control of or property loaned to an insured during the policy period.

Any payment we make for damages because of “property damage” to property in the care, custody and control of or property loaned to an insured will apply against the General Aggregate Limit shown in the declarations.

- b. Our obligation to pay damages on your behalf applies only to the amount of damages in excess of the deductible amount listed above. We may pay any part or all of the deductible amount listed above. We may pay any part or all of the deductible amount to effect settlement of any claim or “suit” and upon notification by us, you will promptly reimburse us for that part of the deductible we paid.
- c. If two or more coverages apply under one “occurrence”, only the highest per claim deductible applicable to these coverages will apply.
- d. Insurance provided by this provision is excess over any other insurance, whether primary, excess, contingent or any other basis. Since insurance provided by this endorsement is excess, we will have no duty to defend any claim or “suit” to which insurance provided by this endorsement applies if any other insurer has a duty to defend such a claim or “suit”. If no other insurer defends, we will undertake to do so, but we will be entitled to the insured’s rights against all those other insurers.

D. PROPERTY DAMAGE – ELEVATORS

Section I – Coverage A.2. Exclusions paragraphs **j.(3), j.(4), j.(6)** and **k.** do not apply to use of elevators. This insurance afforded by this provision is excess over any valid and collectible property insurance (including any deductible) available to the insured and **Section IV – Commercial General Liability Conditions** Paragraph **4. Other Insurance** is changed accordingly.

E. FIRE, LIGHTNING OR EXPLOSION DAMAGE

Except where it is used in the term "hostile fire", the word fire includes fire, lightning or explosion wherever it appears in the Coverage Form.

Under **Section I – Coverage A**, the last paragraph (after the exclusions) is replaced with the following:

Exclusions **c.** through **n.** do not apply to damage by fire, smoke or leakage from automatic fire protection systems to premises while rented to you or temporarily occupied by you with permission of the owner. A separate limit of insurance applies to this coverage as described in **Section III – Limits of Insurance**.

F. MEDICAL PAYMENTS

If **Section I – Coverage C. Medical Payments Coverage** is not otherwise excluded from this Coverage Form:

The requirement, in the Insuring Agreement of Coverage **C.**, that expenses must be incurred and reported to us within **one year** of the accident date is changed to **three years**.

G. SUPPLEMENTARY PAYMENTS

Supplementary Payments – Coverages A and B Paragraphs 1.b. and 1.d. are replaced by the following:

1.b. Up to \$5,000 for cost of bail bonds required because of accidents or traffic law violations arising out of the use of any vehicle to which the Bodily Injury Liability Coverage applies. We do not have to furnish these bonds.

1.d. All reasonable expenses incurred by the insured at our request to assist us in the investigation or defense of the claim or "suit", including actual loss of earnings up to \$500 a day because of time off from work.

H. SUBSIDIARIES AS INSURED

Section II – Who Is An Insured is amended to add the following:

1.f. Any legally incorporated subsidiary in which you own more than 50% of the voting stock on the effective date of this policy. However, insured does not include any subsidiary that is an insured under any other general liability policy, or would have been an insured under such a policy but for termination of that policy or the exhaustion of that policy's limits of liability.

I. BLANKET ADDITIONAL INSURED – AS REQUIRED BY CONTRACT

1. Section II – Who Is An Insured is amended to include as an additional insured any person(s) or organization(s) subject to provisions in Paragraph **2.** below, (hereinafter referred to as additional insured) when you and such person(s) or organization(s) have agreed in a written contract or written agreement that such person(s) or organization(s) be added as an additional insured on your policy provided that the written contract or agreement is:

- a. Currently in effect or becomes effective during the policy period; and
- b. Executed prior to an "occurrence" or offense to which this insurance would apply.

However, the insurance afforded to such additional insured:

- a. Only applies to the extent permitted by law; and
- b. Will not be broader than that which you are required by the contract or agreement to provide for such additional insured; and
- c. Applies only if the person or organization is not specifically named as an additional insured under any other provision of, or endorsement added to, **Section II – Who Is An Insured** of this policy.

2. As provided herein, the insurance coverage provided to such additional insureds is limited to:

- a. Any Controlling Interest, but only with respect to their liability arising out of their financial control of you; or premises they own, maintain, or control while you lease or occupy these premises.

This insurance does not apply to structural alterations, new construction and demolition operations performed by or for that person or organization.

- b. Any architect, engineer, or surveyor engaged by you but only with respect to liability for "bodily injury", "property damage" or "personal and advertising injury" caused, in whole or in part, by your acts or omissions or the acts or omissions of those acting on your behalf:

(1) In connection with your premises; or

(2) In the performance of your ongoing operations.

With respect to the insurance afforded to these additional insureds, the following additional exclusion applies:

This insurance does not apply to "bodily injury", "property damage" or "personal and advertising injury" arising out of the rendering of or the failure to render any professional services by or for you, including:

(1) The preparing, approving, or failing to prepare or approve, maps, shop drawings, opinions, reports, surveys, field orders, change orders or drawings and specifications; or

(2) Supervisory, inspection, architectural or engineering activities.

This exclusion applies even if the claims against any insured allege negligence or other wrongdoing in the supervision, hiring, employment, training or monitoring of others by that insured, if the "occurrence" which caused the "bodily injury" or "property damage", or the offense which caused the "personal and advertising injury", involved the rendering of or the failure to render any professional services by or for you.

- c. Any manager or lessor of a premises leased to you, but only with respect to liability arising out of the ownership, maintenance or use of that part of a premises leased to you, subject to the following additional exclusions:

This insurance does not apply to:

- (1) Any "occurrence" which takes place after you cease to be a tenant in that premises.
- (2) Structural alterations, new construction or demolition operations performed by or on behalf of such additional insured.

- d. Any state or governmental agency or subdivision or political subdivision, subject to the following:

- (1) This insurance applies only with respect to the following hazards for which any state or governmental agency or subdivision or political subdivision has issued a permit or authorization in connection with premises you own, rent or control and to which this insurance applies:

- (a) The existence, maintenance, repair, construction, erection or removal of advertising signs, awnings, canopies, cellar entrances, coal holes, driveways, manholes, marquees, hoist away openings, sidewalk vaults, street banners or decorations and similar exposures; or
- (b) The construction, erection or removal of elevators; or
- (c) The ownership, maintenance or use of any elevators covered by this insurance.

- (2) This insurance applies only with respect to operations performed by you or on your behalf for which any state or governmental agency or subdivision or political subdivision has issued a permit or authorization.

This insurance does not apply to:

- (a) "Bodily injury", "property damage" or "personal and advertising injury" arising out of operations performed for the federal government, state or municipality; or
- (b) "Bodily injury" or "property damage" included within the "products-completed operations hazard".

- e. Any vendor, but only with respect to "bodily injury" or "property damage" arising out of "your products" which are distributed or sold in the regular course of the vendor's business.

With respect to the insurance afforded to these vendors, the following additional exclusions apply:

- (1) The insurance afforded any vendor does not apply to:

- (a) "Bodily injury" or "property damage" for which any vendor is obligated to pay damages by reason of the assumption of liability in a contract or agreement. This exclusion does not apply to liability for damages that any vendor would have in the absence of the contract or agreement;
- (b) Any express warranty unauthorized by you;
- (c) Any physical or chemical change in the product made intentionally by any vendor;
- (d) Repackaging, except when unpacked solely for the purpose of inspection, demonstration, testing, or the substitution of parts under instructions from the manufacturer, and then repackaged in the original container;
- (e) Any failure to make such inspections, adjustments, tests or servicing as any vendor has agreed to make or normally undertakes to make in the usual course of business, in connection with the distribution or sale of the products;
- (f) Demonstration, installation, servicing or repair operations, except such operations performed at any vendor's premises in connection with the sale of the product;
- (g) Products which, after distribution or sale by you, have been labeled or relabeled or used as a container, part or ingredient of any other thing or substance by or for any vendor; or

(h) "Bodily injury" or "property damage" arising out of the sole negligence of any vendor for its own acts or omissions or those of its employees or anyone else acting on its behalf. However, this exclusion does not apply to:

(i) The exceptions contained in Subparagraphs **(d)** or **(f)**; or

(ii) Such inspections, adjustments, tests or servicing as any vendor has agreed to make or normally undertakes to make in the usual course of business, in connection with the distribution or sale of the products.

(2) This insurance does not apply to any insured person or organization, from whom you have acquired such products, or any ingredient, part or container, entering into, accompanying or containing such products.

f. Any Mortgagee, Assignee Or Receiver, but only with respect to their liability as mortgagee, assignee, or receiver and arising out of the ownership, maintenance, or use of the premises by you.

This insurance does not apply to structural alterations, new construction and demolition operations performed by or for that person or organization.

g. Any Owners Or Other Interests From Whom Land Has Been Leased, but only with respect to liability arising out of the ownership, maintenance or use of that part of the land leased to you.

With respect to the insurance afforded to these additional insureds, the following additional exclusions apply:

(1) This insurance does not apply to:

(a) Any "occurrence" which takes place after you cease to lease that land; or

(b) Structural alterations, new construction or demolition operations performed by or on behalf of such additional insured.

h. Any person or organization from whom you lease equipment, but only with respect to liability for "bodily injury", "property damage" or "personal and advertising injury" caused, in whole or in part by your maintenance, operation or use of equipment leased to you by such person(s) or organization(s).

A person's or organization's status as an additional insured under this endorsement ends when their contract or agreement with you for such leased equipment ends.

With respect to the insurance afforded to these additional insureds, this insurance does not apply to any "occurrence" which takes place after the equipment lease expires.

i. Any Owners, Lessees, or Contractors for whom you are performing operations, but only with respect to liability for "bodily injury", "property damage" or "personal and advertising injury" caused, in whole or in part, by:

(1) Your acts or omissions; or

(2) The acts or omissions of those acting on your behalf;

in the performance of your ongoing operations for the additional insured.

A person's or organization's status as an additional insured under this endorsement ends when your operations for that additional insured are completed.

With respect to the insurance afforded to these additional insureds, the following additional exclusions apply:

This insurance does not apply to:

(1) "Bodily injury", "property damage" or "personal and advertising injury" arising out of the rendering of, or the failure to render, any professional architectural, engineering or surveying services, including:

(a) The preparing, approving, or failing to prepare or approve, maps, shop drawings, opinions, reports, surveys, field orders, change orders or drawings and specifications; or

(b) Supervisory, inspection, architectural or engineering activities.

This exclusion applies even if the claims against any insured allege negligence or other wrongdoing in the supervision, hiring, employment, training or monitoring of others by that insured, if the "occurrence" which caused the "bodily injury" or "property damage", or the offense which caused the "personal and advertising injury", involved the rendering of or the failure to render any professional architectural, engineering or surveying services.

(2) "Bodily injury" or "property damage" occurring after:

- (a) All work, including materials, parts or equipment furnished in connection with such work, on the project (other than service, maintenance or repairs) to be performed by or on behalf of the additional insured(s) at the location of the covered operations has been completed; or
 - (b) That portion of "your work" out of which the injury or damage arises has been put to its intended use by any person or organization other than another contractor or subcontractor engaged in performing operations for a principal as a part of the same project.
- j. Any Grantor of Licenses to you, but only with respect to their liability as grantor of licenses to you.
- Their status as additional insured under this endorsement ends when:
- 1. The license granted to you by such person(s) or organization(s) expires; or
 - 2. Your license is terminated or revoked by such person(s) or organization(s) prior to expiration of the license as stipulated by the contract or agreement.
- k. Any Grantor of Franchise, but only with respect to their liability as grantor of a franchise to you.
- l. Any Co-owner of Insured Premises, but only with respect to their liability as co-owner of any insured premises.
- m. Any Concessionaires Trading Under Your Name, but only with respect to their liability as a concessionaire trading under your name.
3. Any insurance provided to any additional insured does not apply to "bodily injury", "property damage" or "personal and advertising injury" arising out of the sole negligence or willful misconduct of the additional insured or its agents, "employees" or any other representative of the additional insured.
4. With respect to the insurance afforded to these additional insureds, the following is added to **Section III – Limits of Insurance:**
- If coverage provided to any additional insured is required by a contract or agreement, the most we will pay on behalf of the additional insured is the amount of insurance:
- a. Required by the contract or agreement; or
 - b. Available under the applicable Limits of Insurance shown in the Declarations;
- whichever is less.

This endorsement shall not increase the applicable Limits of Insurance shown in the Declarations.

J. COVERAGE FOR INJURY TO CO-EMPLOYEES AND/OR YOUR OTHER VOLUNTEER WORKERS

Section II – Who is an Insured, Paragraph 2.a. (1) is amended to add the following:

- e. Paragraphs (a), (b), and (c) do not apply to your "employees" or "volunteer workers" with respect to "bodily injury" to a co-"employee" or other "volunteer worker".

Damages owed to an injured co-"employee" or "volunteer worker" will be reduced by any amount paid or available to the injured co-"employee" or "volunteer worker" under any other valid and collectible insurance.

K. HEALTH CARE SERVICE PROFESSIONALS AS INSURED - INCIDENTAL MALPRACTICE

Section II – Who is an Insured, Paragraph 2.a. (1) (d) is amended as follows:

This provision does not apply to Nurses, Emergency Medical Technicians, or Paramedics who provide professional health care services on your behalf.

However this exception does not apply if you are in the business or occupation of providing any such professional services.

L. NEWLY FORMED OR ACQUIRED ORGANIZATIONS

Section II – Who Is An Insured, Paragraph 3.a. is replaced by the following:

- 3.a. Coverage under this provision is afforded until the end of the policy period.

This provision does not apply if newly formed or acquired organizations coverage is excluded either by the provisions of the Coverage Form or by endorsements.

M. DAMAGE TO PREMISES RENTED TO YOU

Section III – Limits of Insurance, Paragraph 6. is replaced by the following:

Subject to 5.a. above, the Damage To Premises Rented To You Limit, or \$500,000, whichever is higher, is the most we will pay under Coverage A for damages because of "property damage" to any one premises, while rented to you, or in the case of damage by fire, smoke or leakage from automatic protection systems, while rented to you or temporarily occupied by you with permission of the owner.

N. MEDICAL PAYMENTS – INCREASED LIMITS

Section III – Limits of Insurance, Paragraph 7. is replaced by the following:

- 7. Subject to Paragraph 5. above, \$10,000 is the Medical Expense Limit we will pay under Coverage C for all medical expenses because of "bodily injury" sustained by any one person, unless the amount shown on the Declarations of this Coverage Part for Medical Expense Limit states:

- (a) No Coverage; or
- (b) \$1,000; or
- (c) \$5,000; or
- (d) A limit higher than \$10,000.

O. DUTIES IN THE EVENT OF OCCURRENCE, OFFENSE, CLAIM OR SUIT

Section IV – Commercial General Liability Conditions Paragraph 2. is amended to add the following:

- e. The requirement in Condition 2.a. that you must see to it that we are notified as soon as practicable of an “occurrence” or an offense which may result in a claim, applies only when the “occurrence” or offense is known to:
 - (1) You, if you are an individual or a limited liability company;
 - (2) A partner, if you are a partnership;
 - (3) A member or manager, if you are a limited liability company;
 - (4) An “executive officer” or insurance manager, if you are a corporation; or
 - (5) A trustee, if you are a trust.
- f. The requirement in Condition 2.b. that you must see to it that we receive notice of a claim or “suit” as soon as practicable will not be considered breached unless the breach occurs after such claim or “suit” is known to:
 - (1) You, if you are an individual or a limited liability company;
 - (2) A partner, if you are a partnership;
 - (3) A member or manager, if you are a limited liability company;
 - (4) An “executive officer” or insurance manager, if you are a corporation; or
 - (5) A trustee, if you are a trust.

P. PRIMARY AND NONCONTRIBUTORY – ADDITIONAL INSURED EXTENSION

Section IV – Commercial General Liability Conditions Paragraph 4. **Other Insurance** is amended to add the following:

This insurance is primary to and will not seek contribution from any other insurance available to an additional insured under your policy provided that:

- (1) The additional insured is a Named Insured under such other insurance; and
- (2) You have agreed in writing in a contract or agreement that this insurance would be primary and would not seek contribution from any other insurance available to the additional insured. However, if the additional insured has been added as an additional insured on other policies, whether primary, excess, contingent or on any other basis, this insurance is excess over any other insurance regardless of the written agreement between you and an additional insured.

Q. UNINTENTIONAL FAILURE TO DISCLOSE EXPOSURES

Section IV – Commercial General Liability Conditions Paragraph 6. **Representations** is amended to add the following:

If you unintentionally fail to disclose any exposures existing at the inception date of your policy, we will not deny coverage under the Coverage Form solely because of such failure to disclose. However, this provision does not affect our right to collect additional premium or exercise our right of cancellation or non-renewal.

This provision does not apply to any known injury or damage which is excluded under any other provision of this policy.

R. WAIVER OF TRANSFER OF RIGHTS OF RECOVERY AGAINST OTHERS TO US

Section IV – Commercial General Liability Condition Paragraph 8. **Transfer Of Rights Of Recovery Against Others To Us** is amended to add the following:

We waive any right of recovery we may have against any person or organization because of payments we make for injury or damage arising out of:

- 1. Your ongoing operations; or
- 2. “Your work” included in the “products-completed operations hazard”.

However, this waiver applies only when you have agreed in writing to waive such rights of recovery in a contract or agreement, and only if the contract or agreement:

- 1. Is in effect or becomes effective during the term of this policy; and
- 2. Was executed prior to loss.

S. MENTAL ANGUISH

Section V – Definition 3. is replaced by the following:

“Bodily injury” means bodily injury, sickness or disease sustained by a person, including mental anguish or death resulting from bodily injury, sickness or disease.

T. LIBERALIZATION

If we revise this endorsement to provide greater coverage without additional premium charge, we will automatically provide the additional coverage to all endorsement holders as of the day the revision is effective in your state.

THIS ENDORSEMENT CHANGES THE POLICY. PLEASE READ IT CAREFULLY.

**ADDITIONAL INSURED – OWNERS, LESSEES OR CONTRACTORS –
AUTOMATIC STATUS WHEN REQUIRED IN CONSTRUCTION CONTRACT OR
AGREEMENT INCLUDING COMPLETED OPERATIONS – PRIMARY AND
NONCONTRIBUTORY**

This endorsement modifies the insurance provided under the following:

COMMERCIAL GENERAL LIABILITY COVERAGE FORM

A. Section II – Who Is An Insured is amended to include as an additional insured:

1. Any person or organization for whom you are performing operations when you and such person or organization have agreed in writing in a contract or agreement that such person or organization be added as an additional insured on your policy; and
2. Any other person or organization you are required to add as an additional insured under the contract or agreement described in Paragraph 1. above.

Such person(s) or organization(s) is an additional insured only with respect to liability for “bodily injury”, “property damage” or “personal and advertising injury” caused, in whole or in part, by:

- a. Your acts or omissions; or
- b. The acts or omissions of those acting on your behalf;

in the performance of:

- a. your ongoing operations for the additional insured; or
- b. “Your work” for the additional insured and included in the “products – completed operations hazard”.

However, the insurance afforded to such additional insured described above:

- a. Only applies to the extent permitted by law; and
- b. Will not be broader than that which you are required by the contract or agreement to provide for such additional insured.

B. With respect to the insurance afforded to these additional insureds, the following additional exclusion applies:

This insurance does not apply to “bodily injury,” “property damage” and “personal and advertising injury” arising out of the rendering of, or the failure to render, any professional architectural, engineering or surveying services including:

- a. The preparing, approving, or failing to prepare or approve maps, shop drawings, opinions, reports,

surveys, field orders, change orders or drawings and specifications; or

- b. Supervisory, inspection, architectural or engineering activities.

This exclusion applies even if the claims against any insured allege negligence or other wrongdoing in the supervision, hiring, employment, training or monitoring of others by the insured, if the “occurrence” which caused the “bodily injury” or “property damage”, or the offense which caused the “personal and advertising injury”, involved the rendering of, or the failure to render, any professional architectural, engineering or surveying services.

C. With respect to the insurance afforded to these additional insureds, the following is added to **Section III – Limits Of Insurance:**

The most we will pay on behalf of the additional insured is the amount of insurance:

1. Required by the contract or agreement described in Paragraph **A.1.**; or
2. Available under the applicable Limits of Insurance shown in the Declarations;

whichever is less.

This endorsement shall not increase the applicable Limits of Insurance shown in the Declarations.

D. The following is added to the **Other Insurance** Condition and supersedes any provision to the contrary:

Primary and Noncontributory Insurance

This insurance is primary to and will not seek contribution from any other insurance available to an additional insured under your policy provided that:

- (1) The additional insured is a Named Insured under such other insurance; and
- (2) You have agreed in writing in a contract or agreement that this insurance would be primary and would not seek contribution from any other insurance available to the additional insured.

E. All other terms and conditions of this policy remain unchanged.

THIS ENDORSEMENT CHANGES THE POLICY. PLEASE READ IT CAREFULLY.

AMENDMENT — AGGREGATE LIMITS OF INSURANCE (PER PROJECT)

This endorsement modifies insurance provided under the following:

COMMERCIAL GENERAL LIABILITY COVERAGE PART

The General Aggregate Limit under LIMITS OF INSURANCE (Section III) applies separately to each of your projects away from premises owned by or rented to you.

Includes copyrighted material of Insurance Services Office, Inc. with its permission.

THIS ENDORSEMENT CHANGES THE POLICY. PLEASE READ IT CAREFULLY.

COMMERCIAL AUTO ESSENTIAL EXTENSION

This endorsement modifies insurance provided under the following:

BUSINESS AUTO COVERAGE FORM

The BUSINESS AUTO COVERAGE FORM is amended to include the following clarifications and extensions of coverage. With respect to coverage provided by this endorsement, the provisions of the Coverage Form apply unless modified by the endorsement.

A. BLANKET ADDITIONAL INSUREDS

Section II - Covered Autos Liability Coverage is amended to include the following as an "insured":

1. Any person or organization whom you have agreed in a written contract or agreement to name as an additional "insured" under your "auto" Policy to provide "bodily injury" or "property damage" coverage, but only with respects to liability arising out of the use of a covered "auto" you own, hire or borrow and resulting from the acts or omissions by you, any of your "employees" or agents. The insurance afforded to such additional "insured" will not be broader than that which you are required to provide for such additional "insured" and applies only to a written contract executed prior to the "bodily injury" or "property damage" and is still in force at the time of the "accident".
2. The most we will pay on behalf of the additional "insured" is the amount of insurance:
 - a. Required by the written contract or agreement described above, or
 - b. Available under the applicable Limit Of Insurance for Covered Autos Liability Coverage shown in the Declarations;
 whichever is less.

However, any "auto" that is leased, hired, rented or borrowed with a driver is not a covered "auto".

B. NEWLY FORMED OR ACQUIRED ORGANIZATIONS

Section II – Covered Autos Liability Coverage, A.1. Who Is An Insured is amended by adding the following:

- e. Any organization which you acquire or form after the effective date of this Policy in which you maintain ownership or majority interest. However:
 1. Coverage under this provision is afforded only up to 180 days after you acquire or form the organization, or to the end of the Policy period, whichever is earlier.
 2. Any organization you acquire, or form will not be considered an "insured" if:

- a. The organization is a partnership or a limited liability company; or
 - b. That organization is covered under other similar insurance.
3. Coverage under this provision does not apply to any claim for "bodily injury" or "property damage" resulting from an "accident" that occurred before you formed or acquired the organization.

C. SUBSIDIARIES AS INSUREDS

Section II – Covered Autos Liability Coverage, A.1. Who Is An Insured is amended by adding the following:

Any legally incorporated subsidiary in which you own more than 50% of the voting stock on the effective date of this Policy. However, "insured" does not include any subsidiary that is an "insured" under any other automobile liability Policy or was an "insured" under such a Policy but for termination of that Policy or the exhaustion of the Policy's limits of liability.

D. SUPPLEMENTARY PAYMENTS

Section II – Covered Autos Liability Coverage, A.2.a. Coverage Extensions, Supplementary Payments (2) and (4) are replaced by the following:

- (2) Up to \$3,000 for cost of bail bonds (including bonds for related traffic law violations) required because of an "accident" we cover. We do not have to furnish these bonds.
- (4) All reasonable expenses incurred by the "insured" at our request, including actual loss of earnings up to \$350 a day because of time off from work.

E. TOWING AND LABOR

Section III – Physical Damage Coverage, A.2. Towing And Labor is replaced with the following:

We will pay for **Towing And Labor** costs incurred, subject to the following:

- a. Up to \$100 each time a covered "auto" that is a private passenger type is disabled; or
- b. Up to \$500 each time a covered "auto" other than the private passenger type is disabled.

However, the labor must be performed at the place of disablement.

F. LOCKSMITH SERVICES

Section III – Physical Damage Coverage, A.4. Coverage Extensions is amended by adding the following:

We will pay up to \$50 per occurrence for necessary locksmith services for keys locked inside a covered private passenger "auto" for which Comprehensive Coverage is provided. The deductible is waived for these services.

G. TRANSPORTATION EXPENSES

Section III – Physical Damage Coverage, A.4. Coverage Extensions Subparagraph a. **Transportation Expenses** is replaced by the following:

- (1) We will pay up to \$75 per day to a maximum of \$1,000 for temporary transportation expense incurred by you because of the total theft of a covered "auto" of the private passenger type. We will pay only for those covered "autos" for which you carry either Comprehensive or Specified Cause of Loss Coverage. We will pay for temporary transportation expenses incurred during the period beginning 48 hours after the theft and ending, regardless of the Policy's expiration, when the covered "auto" is returned to use or we pay for its "loss".
- (2) If the temporary transportation expenses you incur arise from your rental of an "auto" of the private passenger type, the most we will pay is the amount it costs to rent an "auto" of the private passenger type which is of the same like, kind and quality as the stolen covered "auto".

H. ELECTRONIC EQUIPMENT COVERAGE ADDED LIMITS

All electronic equipment that reproduces, receives or transmits audio, visual, and data electronic equipment signals in any one loss is \$1,000 Per "Loss" are in addition to the sublimit in Paragraph C.1.b. of the Limits Of Insurance Provision under **Section III – Physical Damage Coverage**.

I. HIRED AUTO PHYSICAL DAMAGE

Section III – Physical Damage Coverage, A.4. Coverage Extensions is amended by adding the following:

If hired "autos" are covered "autos" for Liability Coverage, and if Comprehensive, Specified Causes of Loss, or Collision Coverage is provided for any "auto" you own, then the Physical Damage Coverages provided are extended to "autos" you lease, hire, rent or borrow subject to the following limit and deductible:

1. The most we will pay for loss to any leased, hired, rented or borrowed "auto" is the lesser of Actual Cash Value, \$75,000, or Cost of Repair, minus the deductible.
2. The deductible will be equal to the largest deductible applicable to any owned "auto" for that coverage.

3. Subject to the above limit and deductible provisions, we will provide coverage equal to the broadest coverage applicable to any covered "auto" you own.

We will pay up to \$1,000, in addition to the limit above, for **Loss Of Use Expenses** of a hired "auto" to a leasing or rental concern for a monetary loss sustained, provided it results from an "accident" for which you are legally liable.

However, coverage does not apply to any "auto" leased, hired, rented or borrowed in your Motor Carrier Operations and any "auto" that is leased, hired, rented or borrowed with a driver is not a covered "auto".

J. PERSONAL PROPERTY OF OTHERS

Section III – Physical Damage Coverage, A.4. Coverage Extensions is amended by adding the following:

We will pay up to \$500 for loss to Personal Property Of Others that was damaged while in or on your covered "auto" at the time of a covered "auto" loss.

No deductibles apply to this coverage.

K. RENTAL REIMBURSEMENT EXPENSES

Section III – Physical Damage Coverage, A.4. Coverage Extensions is amended by adding the following:

1. This coverage applies only to a covered "auto" for which **Physical Damage Coverage** is provided on this Policy.
2. We will pay for **Rental Reimbursement Expenses** incurred by you for the rental of an "auto" because of "loss" to a covered "auto". Payment applies in addition to the otherwise applicable amount of each coverage you have on a covered "auto". No deductibles apply to this coverage.
3. We will pay only for those expenses incurred during the Policy period beginning 24 hours after the "loss" and ending, regardless of the Policy's expiration, with the lesser of the following number of days:
 - a. The number of days reasonably required to repair or replace the covered "auto". If "loss" is caused by theft, this number of days is added to the number of days it takes to locate the covered "auto" and return it to you; or
 - b. 30 days.
4. Our payment is limited to the lesser of the following amounts:
 - a. Necessary and actual expenses incurred; or
 - b. \$50 per day, subject to a \$1,500 limit.
5. This coverage does not apply while there are spare or reserve "autos" available to you for your operations.

6. If "loss" results from the total theft of a covered "auto" of the private passenger type, we will pay under this coverage only that amount of your **Rental Reimbursement Expenses** which is not already provided for under the Physical Damage – Transportation Expense coverage extension included in this endorsement.
7. Coverage provided by this extension is excess over any other collectible insurance and/or endorsement to this Policy.

L. AIRBAG COVERAGE

Section III – Physical Damage Coverage, B.3.a. Exclusions is amended by adding the following:

If you have purchased Comprehensive or Collision Coverage under this Policy, the exclusion relating to mechanical breakdown does not apply to the accidental discharge of an airbag.

M. LOSS TO TWO OR MORE COVERED AUTOS FROM ONE ACCIDENT

Section III – Physical Damage Coverage, D. Deductible Subparagraph 2. is replaced by the following:

2. Regardless of the number of covered "autos" damaged or stolen the maximum deductible applicable for all "loss" in any one event caused by:
 - a. Theft or Mischief or Vandalism; or
 - b. All Perils
 - c. Collision

Will be equal to two times the highest deductible applicable to any one covered "auto" on the Policy for Comprehensive, Specified Causes of Loss or Collision Coverage. The application of the highest deductible used to calculate the maximum deductible will be made regardless of which covered "autos" were damaged or stolen in the "loss".

N. FULL GLASS COVERAGE

Section III – Physical Damage Coverage, D. Deductible is amended by the addition of the following:

If the Comprehensive Coverage applies to the covered "autos", no Comprehensive Coverage Deductible applies to the cost of repairing or replacing damaged glass on the covered "auto(s)".

O. PHYSICAL DAMAGE DEDUCTIBLE – VEHICLE TRACKING SYSTEM

Section III – Physical Damage D. Deductible is amended by adding the following:

Comprehensive Coverage Deductible shown in the Declaration will be reduced by 50% for any "loss" caused by theft of the vehicle when equipped with a vehicle tracking device such as a radio tracking device or a global positioning device and that device was the method of recovery of the vehicle.

P. DUTIES IN THE EVENT OF ACCIDENT, CLAIM, SUIT, OR LOSS

Section IV – Business Auto Conditions, A.2. Duties In The Event Of Accident, Claim, Suit Or Loss is amended by adding the following:

- d. Your obligation to notify us promptly of an "accident", claim, "suit" or "loss" is satisfied if you send us the required notice as soon as practicable after your Insurance Administrator or anyone else designated by you to be responsible for insurance matters is notified, or in any manner made aware, of an "accident", claim, "suit" or "loss".

Q. UNINTENTIONAL FAILURE TO DISCLOSE EXPOSURES

Section IV – Business Auto Conditions, B.2. Concealment, Misrepresentation, Or Fraud is amended by adding the following:

If you unintentionally fail to disclose any exposures existing at the inception date of this policy, we will not deny coverage under this Coverage Part solely because of such failure to disclose. However, this provision does not affect our right to collect additional premium or exercise our right of cancellation or non-renewal.

R. MENTAL ANGUISH

Section V – Definitions, C. is replaced by the following:

"Bodily injury" means bodily injury, sickness or disease sustained by a person, including mental anguish or death resulting from bodily injury, sickness or disease.

S. LIBERALIZATION

Paragraph **B.3. Liberalization** is amended for this endorsement as follows:

If we revise this endorsement to provide greater coverage without additional premium charge, we will automatically provide the additional coverage to all endorsement holders as of the day the revision is effective in your state.

THIS ENDORSEMENT CHANGES THE POLICY. PLEASE READ IT CAREFULLY.

**BLANKET WAIVER OF SUBROGATION WHEN REQUIRED
IN A WRITTEN CONTRACT OR AGREEMENT**

This endorsement modifies insurance provided under the following:

AUTO DEALERS COVERAGE FORM
BUSINESS AUTO COVERAGE FORM
MOTOR CARRIER COVERAGE FORM

The **TRANSFER OF RIGHTS OF RECOVERY AGAINST OTHERS TO US** Condition Section is added to and replaced by the following:

We waive any right of recovery we may have against any person or organization against whom you have agreed to waive such right of recovery in a written agreement or written contract because of payments we make for injury or damage arising out of your ongoing operations or "work you performed" under a written contract or written agreement with that person or organization and included in the "Auto Dealers Operations".

- A.** The following definitions are added to the **Definition** Section of this endorsement only:
- 1.** "Auto Dealers Operations" means the ownership, maintenance or use of locations for an "auto" dealership and that portion of the roads or other accesses that adjoin these locations. "Auto dealers operations" includes all operations necessary or incidental to an "auto" dealership.
 - 2.** "Work you performed" includes:
 - a.** Work that someone performed on your behalf; and
 - b.** The providing of or failure to provide warnings or instructions.

NCCI #: WC000313B
Policy #: 4142675

Applied Ingenuity LLC
14920 Harvest Rd
Brighton, CO 80603

Hub International Insurance Service
2000 S. Colorado Blvd.
Tower 2, Suite 150
Denver, CO 80222
(888) 795-0300

ENDORSEMENT: Blanket Waiver of Subrogation

We have the right to recover our payments from anyone liable for an injury covered by this policy. We will not enforce our right against the person or organization named in the Schedule. This agreement applies only to the extent that you perform work under a written contract that requires you to obtain this agreement from us.

This agreement shall not operate directly or indirectly to benefit anyone not named in the Schedule.

SCHEDULE

To any person or organization when agreed to under a written contract or agreement, as defined above and with the insured, which is in effect and executed prior to any loss.

Effective Date: October 1, 2023 Expires on: October 1, 2024
Pinnacol Assurance has issued this endorsement September 20, 2023

**EXHIBIT 4****TOWN OF CASTLE ROCK
AFFIDAVIT OF INDEPENDENT CONTRACTOR STATUS**

In accordance with Section 8-70-115, C.R.S., I certify the following:

- With respect to the Agreement, **APPLIED INGENUITY, LLC** (“Entity”) represents and warrants that it is the Entity’s express intention to be employed as an independent contractor of the Town of Castle Rock (the “Town”) for purposes of performing the work or services which are the subject of the Agreement, to include all employees and agents of the above-named entity. Entity understands and confirm that the Town reasonably relied on this intention in entering into the Agreement.
- The Town does not require Entity work exclusively for the Town, except that Entity may choose to work exclusively for the Town for a finite period of time specified in the document.
- The Town does not establish a quality standard for the work or services performed pursuant to the Agreement, except that the Town may provide plans and specifications regarding the work but cannot oversee the actual work or provide instruction as to how the work is performed.
- The Town does not pay a salary or hourly rate but rather a fixed or contract rate, as noted in the terms and conditions of the Agreement, and any Exhibits made part of the Agreement.
- The Town cannot terminate the work or services performed during the contract period unless otherwise agreed to in the terms and conditions of the Agreement.
- Entity is not provided with anything, if at all, more than minimal training from the Town.
- The Town does not provide Entity with tools or benefits for the performance of the work or services which are the subject of the Agreement, except materials and equipment may be supplied.
- The Town does not dictate the time of performance, except that a completion schedule and a range of mutually agreeable work hours may be established in the Agreement.
- The Town does not pay Entity personally but rather makes checks payable to the trade or business name of the Entity, who is a party to the Agreement; and the Town does not combine their business operations in any way with the entity’s business, but instead maintains such operations as separate and distinct.
- Entity understands that if a professional license to practice a particular occupation under the laws of the State of Colorado requires the exercise of a supervisory function with regard to the work of services performed under this Agreement, such supervisory role shall not affect the independent contractor relationship with the Town.
- **ENTITY UNDERSTANDS THAT NEITHER ENTITY NOR ITS EMPLOYEES ARE ENTITLED TO UNEMPLOYMENT INSURANCE BENEFITS OF THE TOWN.**

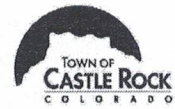

- ENTITY UNDERSTANDS THAT IT IS OBLIGATED TO PAY FEDERAL AND STATE INCOME TAX ON MONEYS PAID PURSUANT TO THE AGREEMENT.

CONTRACTOR

APPLIED INGENUITY, LLC

By: [Signature]

Name

STATE OF COLORADO)

) ss.

COUNTY OF Adams)

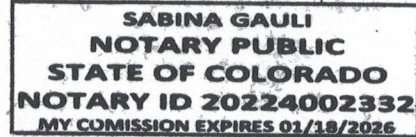

The foregoing instrument as acknowledged before me this 14th day of October, 2023 by Fred S. Martin as president of the above-mentioned Contractor.

Witness my official hand and seal.

My commission expires: 01/18/26

[Signature]

Notary Public